

May.1.2019 Copyright 2019 HIROSE ELECTRIC CO., LTD. All Rights Reserved.
In case of consideration for using Automotive equipment / device which demand high reliability, kindly contact our sales window correspondents.

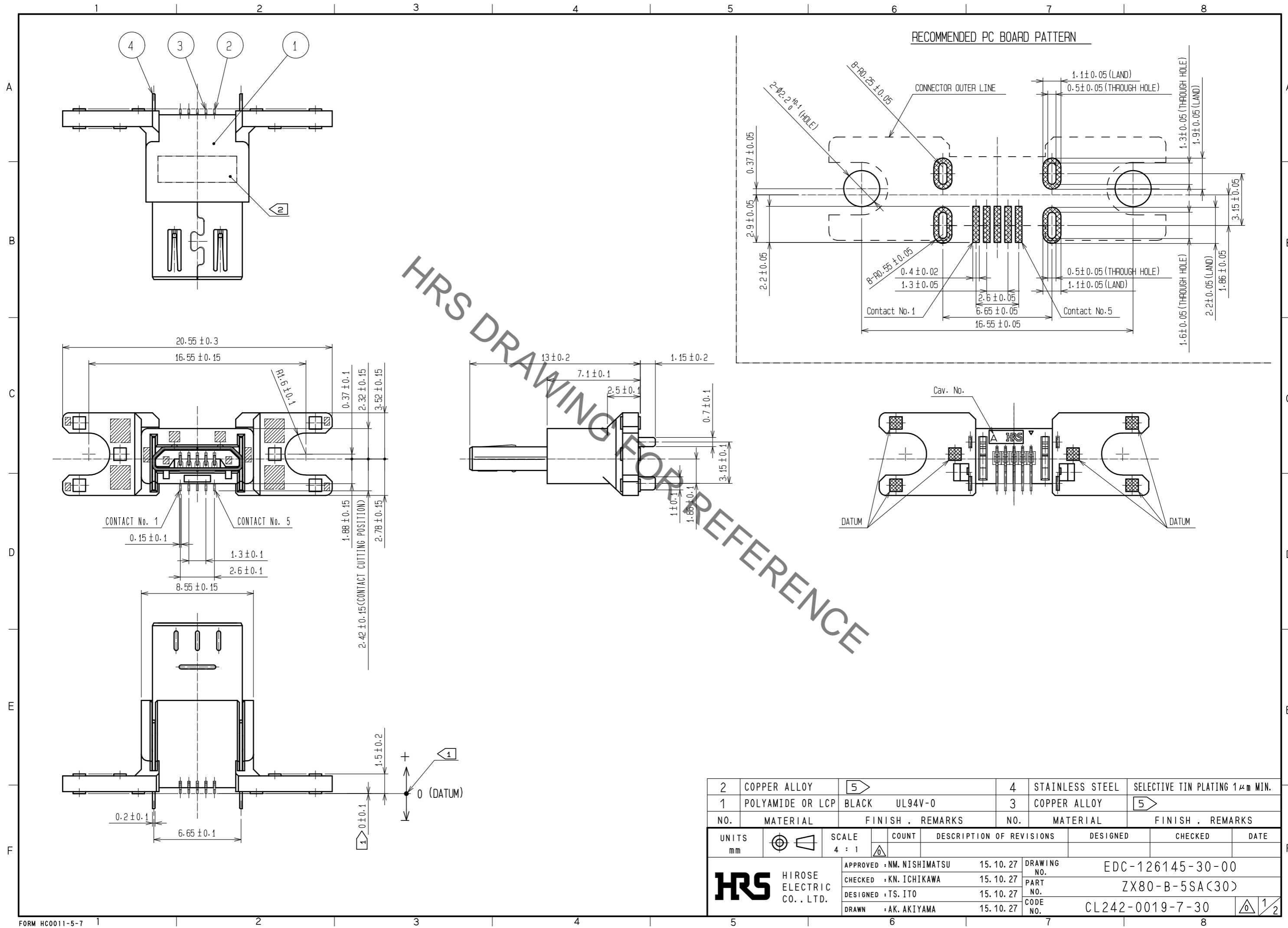

HRS DRAWING FOR REFERENCE

2	COPPER ALLOY	5	4	STAINLESS STEEL	SELECTIVE TIN PLATING 1 μm MIN.
1	POLYAMIDE OR LCP	BLACK UL94V-0	3	COPPER ALLOY	5
NO.	MATERIAL	FINISH . REMARKS	NO.	MATERIAL	FINISH . REMARKS
UNITS	mm	SCALE	4 : 1	COUNT	Δ
DESCRIPTION OF REVISIONS		DESIGNED	CHECKED	DATE	
APPROVED : NM. NISHIMATSU		15.10.27	DRAWING NO. EDC-126145-30-00		
CHECKED : KN. ICHIKAWA		15.10.27	PART NO. ZX80-B-5SA(30)		
DESIGNED : TS. ITO		15.10.27	CODE NO. CL242-0019-7-30		
DRAWN : AK. AKIYAMA		15.10.27	1/2		

May.1.2019 Copyright 2019 HIROSE ELECTRIC CO., LTD. All Rights Reserved.
In case of consideration for using Automotive equipment / device which demand high reliability, kindly contact our sales window correspondents.

3 FIG-2 DRAWING FOR PACKING(AT 2000 pcs PACKING.)
THIS IS ONE EXAMPLE OF PACKING METHOD, AND IT MAY CHANGE WITHOUT ANY NOTICE, DEPENDING ON VOLUME.

1. STORE CONNECTORS IN A TRAY.

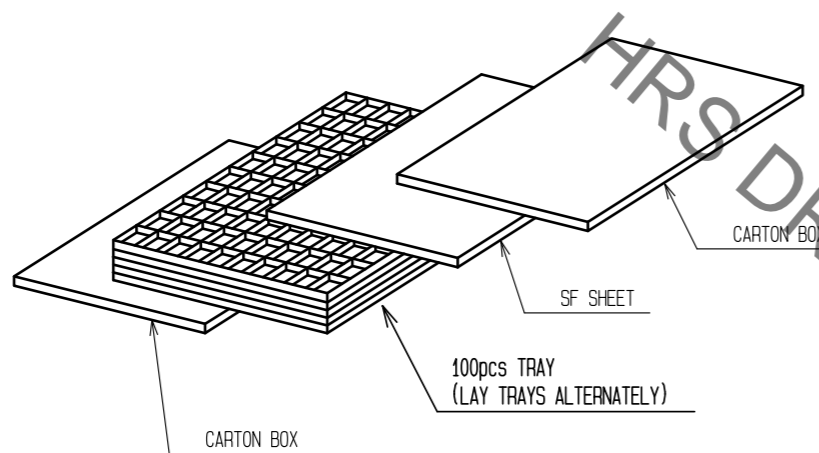

2. BAND TRAYS AS SHOWN BELOW.

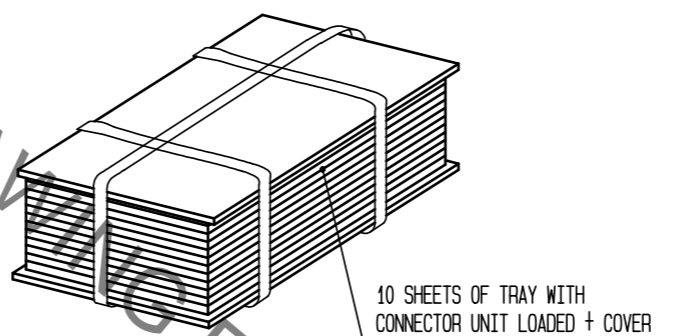

3. STORE 2 UNITS OF BANDED TRAY INTO A CARTON BOX(K-1)
(STORE A BOUNDARY PLATE ON TOP OF THE SURFACE, THEN CLOSE THE BOX BY STICKING GUMMED TAPE IN FOUR PARTS)

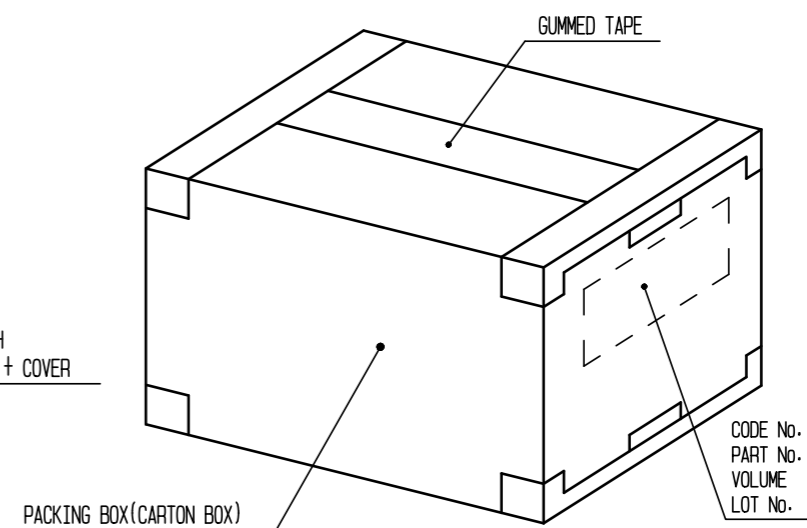

NOTES. 1 DIMENSIONS OF SMT RANGE AND CO-PLANARITY ARE AS SHOWN BELOW.

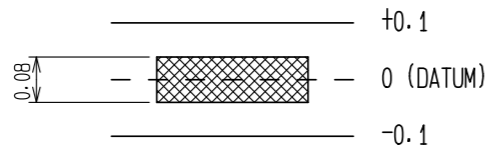

- 2 LOT No. SHALL BE INDICATED AT THE POSITION AS SHOWN.
- 3 THIS PRODUCT IS TRAY PACKING, AND 100 CONNECTORS FOR EACH TRAY. MINIMUM ORDER QUANTITY WILL BE 100 pcs PER UNIT.
- 4 THE SHADED AREAS SHOW LOCATIONS OF EJECTOR PINS.
- 5 PLATING
CONTACT AREA : GOLD 0.75μm MIN.
READ AREA : GOLD 0.03μm MIN.
UNDER PLATING: NICKEL 2μm MIN.

HRS DRAWING FOR REFERENCE

HRS	DRAWING NO.	EDC-126145-30-00
	PART NO.	ZX80-B-5SA(30)
	CODE NO.	CL242-0019-7-30

2/2