

To our customers,

Old Company Name in Catalogs and Other Documents

On April 1st, 2010, NEC Electronics Corporation merged with Renesas Technology Corporation, and Renesas Electronics Corporation took over all the business of both companies. Therefore, although the old company name remains in this document, it is a valid Renesas Electronics document. We appreciate your understanding.

Renesas Electronics website: <http://www.renesas.com>

April 1st, 2010
Renesas Electronics Corporation

Issued by: Renesas Electronics Corporation (<http://www.renesas.com>)

Send any inquiries to <http://www.renesas.com/inquiry>.

Notice

1. All information included in this document is current as of the date this document is issued. Such information, however, is subject to change without any prior notice. Before purchasing or using any Renesas Electronics products listed herein, please confirm the latest product information with a Renesas Electronics sales office. Also, please pay regular and careful attention to additional and different information to be disclosed by Renesas Electronics such as that disclosed through our website.
2. Renesas Electronics does not assume any liability for infringement of patents, copyrights, or other intellectual property rights of third parties by or arising from the use of Renesas Electronics products or technical information described in this document. No license, express, implied or otherwise, is granted hereby under any patents, copyrights or other intellectual property rights of Renesas Electronics or others.
3. You should not alter, modify, copy, or otherwise misappropriate any Renesas Electronics product, whether in whole or in part.
4. Descriptions of circuits, software and other related information in this document are provided only to illustrate the operation of semiconductor products and application examples. You are fully responsible for the incorporation of these circuits, software, and information in the design of your equipment. Renesas Electronics assumes no responsibility for any losses incurred by you or third parties arising from the use of these circuits, software, or information.
5. When exporting the products or technology described in this document, you should comply with the applicable export control laws and regulations and follow the procedures required by such laws and regulations. You should not use Renesas Electronics products or the technology described in this document for any purpose relating to military applications or use by the military, including but not limited to the development of weapons of mass destruction. Renesas Electronics products and technology may not be used for or incorporated into any products or systems whose manufacture, use, or sale is prohibited under any applicable domestic or foreign laws or regulations.
6. Renesas Electronics has used reasonable care in preparing the information included in this document, but Renesas Electronics does not warrant that such information is error free. Renesas Electronics assumes no liability whatsoever for any damages incurred by you resulting from errors in or omissions from the information included herein.
7. Renesas Electronics products are classified according to the following three quality grades: “Standard”, “High Quality”, and “Specific”. The recommended applications for each Renesas Electronics product depends on the product’s quality grade, as indicated below. You must check the quality grade of each Renesas Electronics product before using it in a particular application. You may not use any Renesas Electronics product for any application categorized as “Specific” without the prior written consent of Renesas Electronics. Further, you may not use any Renesas Electronics product for any application for which it is not intended without the prior written consent of Renesas Electronics. Renesas Electronics shall not be in any way liable for any damages or losses incurred by you or third parties arising from the use of any Renesas Electronics product for an application categorized as “Specific” or for which the product is not intended where you have failed to obtain the prior written consent of Renesas Electronics. The quality grade of each Renesas Electronics product is “Standard” unless otherwise expressly specified in a Renesas Electronics data sheets or data books, etc.
 - “Standard”: Computers; office equipment; communications equipment; test and measurement equipment; audio and visual equipment; home electronic appliances; machine tools; personal electronic equipment; and industrial robots.
 - “High Quality”: Transportation equipment (automobiles, trains, ships, etc.); traffic control systems; anti-disaster systems; anti-crime systems; safety equipment; and medical equipment not specifically designed for life support.
 - “Specific”: Aircraft; aerospace equipment; submersible repeaters; nuclear reactor control systems; medical equipment or systems for life support (e.g. artificial life support devices or systems), surgical implantations, or healthcare intervention (e.g. excision, etc.), and any other applications or purposes that pose a direct threat to human life.
8. You should use the Renesas Electronics products described in this document within the range specified by Renesas Electronics, especially with respect to the maximum rating, operating supply voltage range, movement power voltage range, heat radiation characteristics, installation and other product characteristics. Renesas Electronics shall have no liability for malfunctions or damages arising out of the use of Renesas Electronics products beyond such specified ranges.
9. Although Renesas Electronics endeavors to improve the quality and reliability of its products, semiconductor products have specific characteristics such as the occurrence of failure at a certain rate and malfunctions under certain use conditions. Further, Renesas Electronics products are not subject to radiation resistance design. Please be sure to implement safety measures to guard them against the possibility of physical injury, and injury or damage caused by fire in the event of the failure of a Renesas Electronics product, such as safety design for hardware and software including but not limited to redundancy, fire control and malfunction prevention, appropriate treatment for aging degradation or any other appropriate measures. Because the evaluation of microcomputer software alone is very difficult, please evaluate the safety of the final products or system manufactured by you.
10. Please contact a Renesas Electronics sales office for details as to environmental matters such as the environmental compatibility of each Renesas Electronics product. Please use Renesas Electronics products in compliance with all applicable laws and regulations that regulate the inclusion or use of controlled substances, including without limitation, the EU RoHS Directive. Renesas Electronics assumes no liability for damages or losses occurring as a result of your noncompliance with applicable laws and regulations.
11. This document may not be reproduced or duplicated, in any form, in whole or in part, without prior written consent of Renesas Electronics.
12. Please contact a Renesas Electronics sales office if you have any questions regarding the information contained in this document or Renesas Electronics products, or if you have any other inquiries.

(Note 1) “Renesas Electronics” as used in this document means Renesas Electronics Corporation and also includes its majority-owned subsidiaries.

(Note 2) “Renesas Electronics product(s)” means any product developed or manufactured by or for Renesas Electronics.

MONOLITHIC POWER MOS FET ARRAY

DESCRIPTION

The μPA1602 is Monolithic N-channel Power MOS FET Array that built in 7 circuits designed for LED, Relay, Thermal Head, and so on.

FEATURES

- Direct driving is possible by standard Logic IC or Microcomputer. (4 V driving is possible)
- Output Voltage: $V_o = 30$ V MAX.
Output Current: $I_o = 500$ mA MAX.
- Low Input Active
- $R_{on} = 3 \Omega$ TYP. at: $I_o = 150$ mA, $V_i = 4.5$ V
- Large Operation Temperature: -40 to $+85$ °C

ORDERING INFORMATION

Part Number	Package	Quality Grade
μPA1602CX	16-Pin DIP	Standard
μPA1602GS	16-Pin SOP	Standard

Please refer to "Quality grade on NEC Semiconductor Devices" (Document number IEI-1209) published by NEC Corporation to know the specification of quality grade on the devices and its recommended applications.

ABSOLUTE MAXIMUM RATINGS ($T_a = 25$ °C)

Supply Voltage	V_{DD}	-0.5 to $+7.0$	V
Output Voltage	$V_{O(DC)}$	30	V
Output Peak Voltage*	$V_{O(peak)}$	50	V
Input Voltage	V_i	-0.5 to $V_{DD} + 0.5$	V
Output Current (DC)	$I_{O(DC)}$	430	mA/unit
Output Current (pulse)**	$I_{O(pulse)}$	500	mA/unit
Input Current	I_i	± 10	mA/unit
Total Power Dissipation	P_T	1.0	W/PKG
Operating Temperature	T_{opt}	-40 to $+85$	°C
Storage Temperature	T_{stg}	-55 to $+150$	°C

* $PW \leq 10$ ms, Duty Cycle ≤ 10 %

** $PW \leq 10$ ms, Duty Cycle ≤ 30 %

CONNECTION DIAGRAM

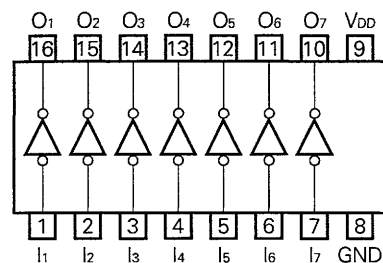

I : Input
O : Output
 V_{DD} : Supply Voltage

Equivalent Circuits (1/7 Circuit)

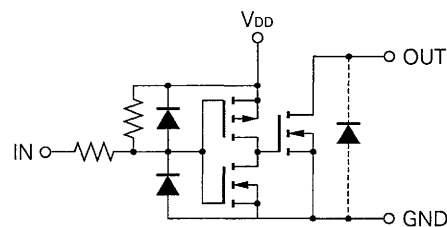

RECOMMENDED OPERATING CONDITIONS (T_a = -40 to +85 °C)

CHARACTERISTIC	SYMBOL	MIN.	TYP.	MAX.	UNIT	TEST CONDITIONS
Supply Voltage	V _{DD}	4.5	5.0	5.5	V	
Output Voltage	V _{O(DC)}			24	V	
Output Current	I _{O(DC)}			270	mA/unit	DC, 1 circuit
	I _{O(pulse)}			200	mA/unit	PW ≤ 10 ms, Duty Cycle ≤ 25 %, 7 circuits
Input Voltage	V _I	0		5	V	
High-Level Input Voltage	V _{IH}	2			V	
Low-Level Input Voltage	V _{IL}			0.8	V	

ELECTRICAL CHARACTERISTICS (T_a = 25 °C)

CHARACTERISTIC	SYMBOL	MIN.	TYP.	MAX.	UNIT	TEST CONDITIONS
Supply Current	I _{DD(ON)}			1	mA	V _{DD} = 5.5 V, V _I = 0
	I _{DD(OFF)}			10	μA	V _{DD} = 5.5 V, V _I = 5.5 V
Output Leakage Current	I _{O(OFF)}			10	μA	V _{DD} = 5.5 V, V _I = 5.5 V, V _O = 30 V
Output On-state Resistance	R _{on}		3	5.3	Ω	V _{DD} = 4.5 V, V _I = 0, I _O = 150 mA
Output On-state Voltage	V _{O(ON)1}			0.1	V	V _{DD} = 4.5 V, V _I = 0, I _O = 10 mA
	V _{O(ON)2}			1.0	V	V _{DD} = 4.5 V, V _I = 0, I _O = 150 mA
Input Voltage	V _{I(OFF)}	2			V	V _{DD} = 5 V, V _O = 50 V, I _O = 100 μA
	V _{I(ON)}			0.8	V	V _{DD} = 5 V, V _O = 0.8 V, I _O = 1 mA
Input Current	I _{IH}			10	μA	V _{DD} = 5.5 V, V _I = 5.5 V, V _O = 0 V
	I _{IL}			-1.0	mA	V _{DD} = 5.5 V, V _I = 0 V, V _O = 50 V
Input Capacitance	C _{in}		10		pF	f = 1 MHz
Delay Time	t _{PHL}		30		ns	V _{CC} = 10 V, R _L = 100 Ω V _{DD} = 5 V, C _L = 15 pF
	t _{PLH}		110		ns	
Rise Time	t _{TLH}		80		ns	t _r , t _f ≤ 5 ns
Fall Time	t _{THL}		80		ns	See Fig. 1

Fig. 1 Switching Wave Forms and Test Circuits

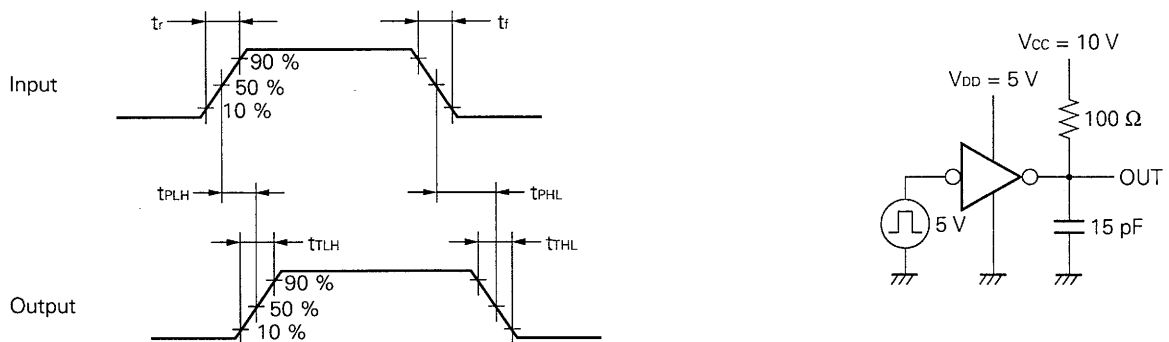

TYPICAL CHARACTERISTICS ($T_a = 25^\circ\text{C}$)

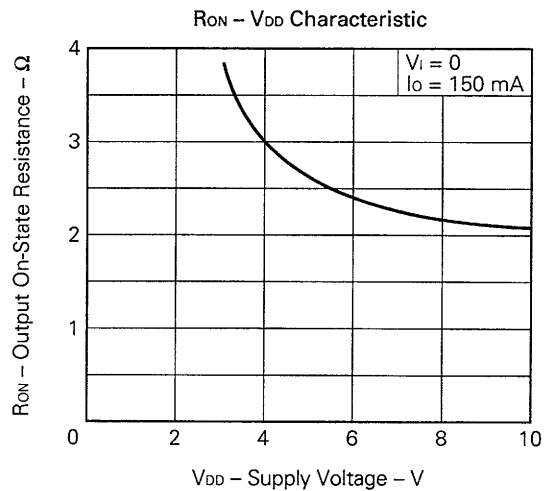
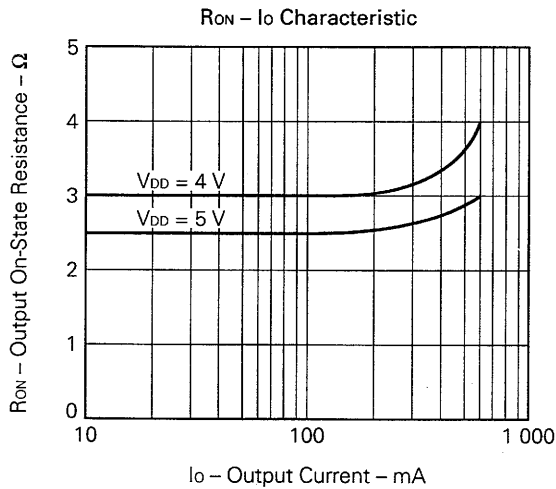
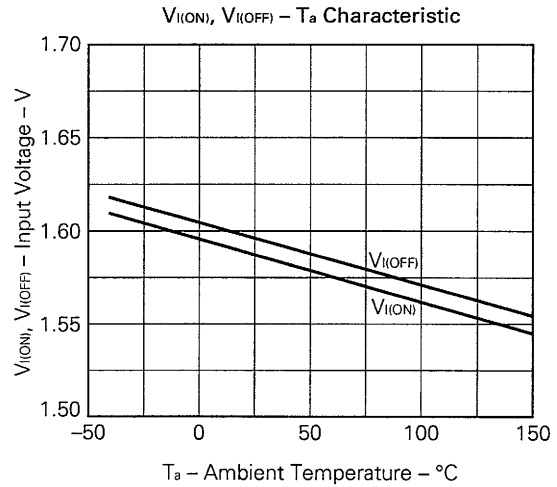
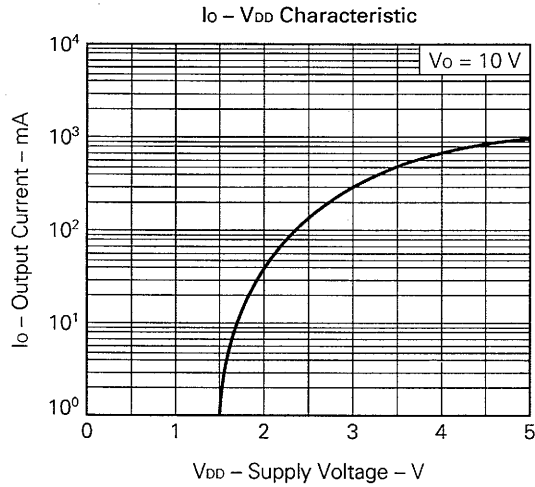
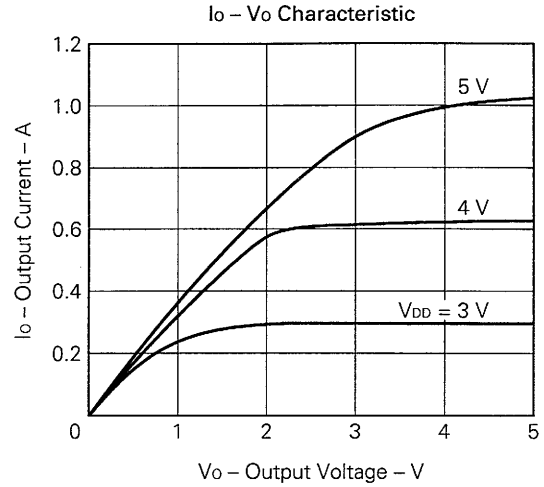
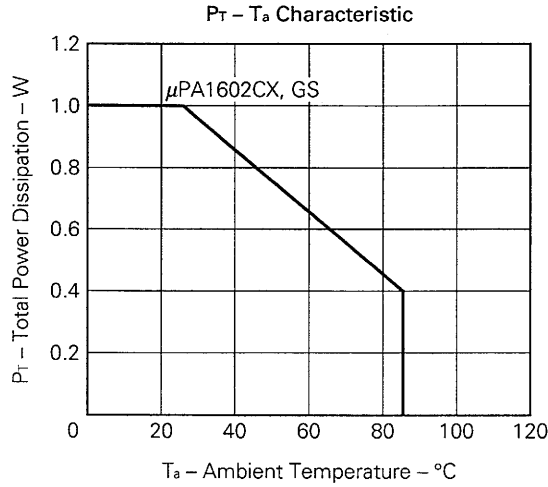

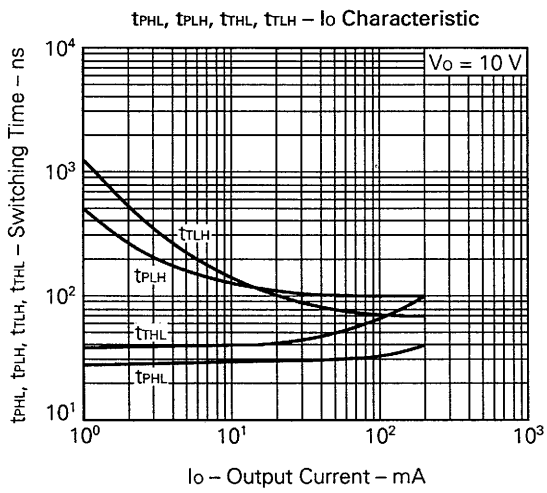
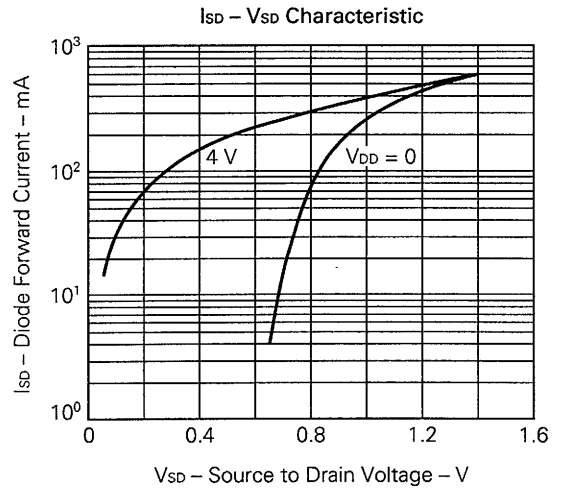
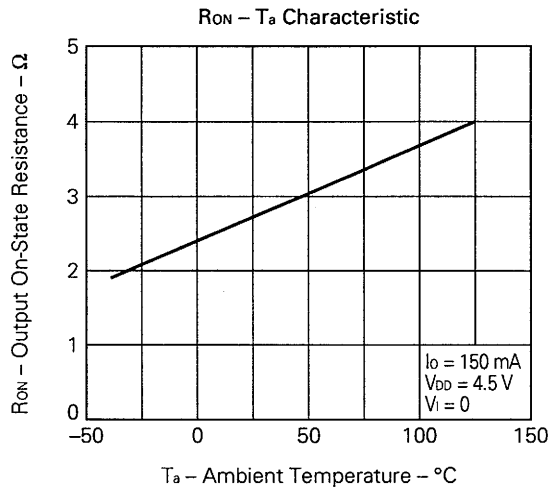

PACKAGE DIMENSIONS

• μPA1602CX

16PIN PLASTIC DIP (300 mil)

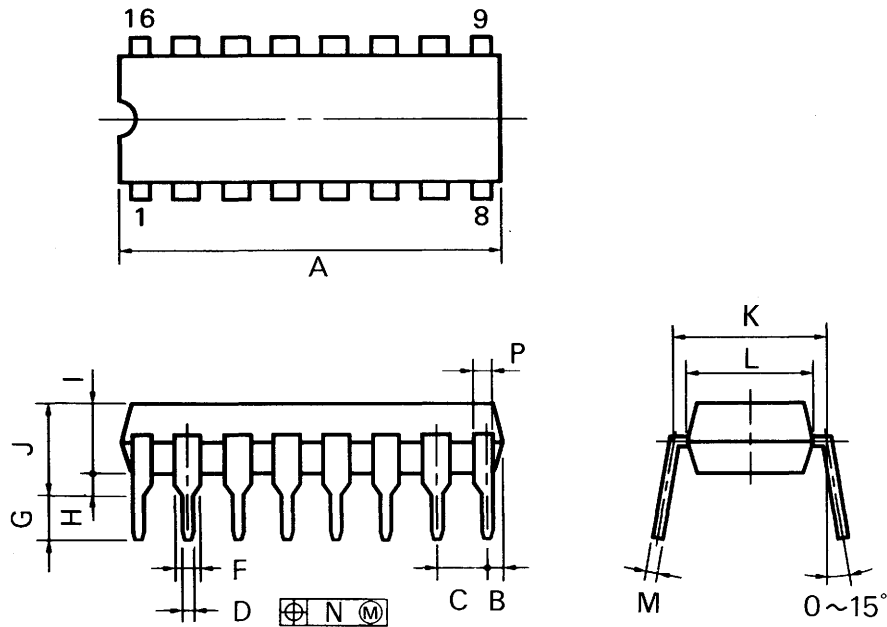

P16C-100-300A.C

NOTES

- 1) Each lead centerline is located within 0.25 mm (0.01 inch) of its true position (T.P.) at maximum material condition.
- 2) Item "K" to center of leads when formed parallel.

ITEM	MILLIMETERS	INCHES
A	20.32 MAX.	0.800 MAX.
B	1.27 MAX.	0.050 MAX.
C	2.54 (T.P.)	0.100 (T.P.)
D	0.50 ^{±0.10}	0.020 ^{+0.004} _{-0.005}
F	1.2 MIN.	0.047 MIN.
G	3.5 ^{±0.3}	0.138 ^{±0.012}
H	0.51 MIN.	0.020 MIN.
I	4.31 MAX.	0.170 MAX.
J	5.08 MAX.	0.200 MAX.
K	7.62 (T.P.)	0.300 (T.P.)
L	6.4	0.252
M	0.25 ^{+0.10} _{-0.05}	0.010 ^{+0.004} _{-0.003}
N	0.25	0.01
P	1.0 MIN.	0.039 MIN.

• μPA1602GS
16 PIN PLASTIC SOP (300 mil)

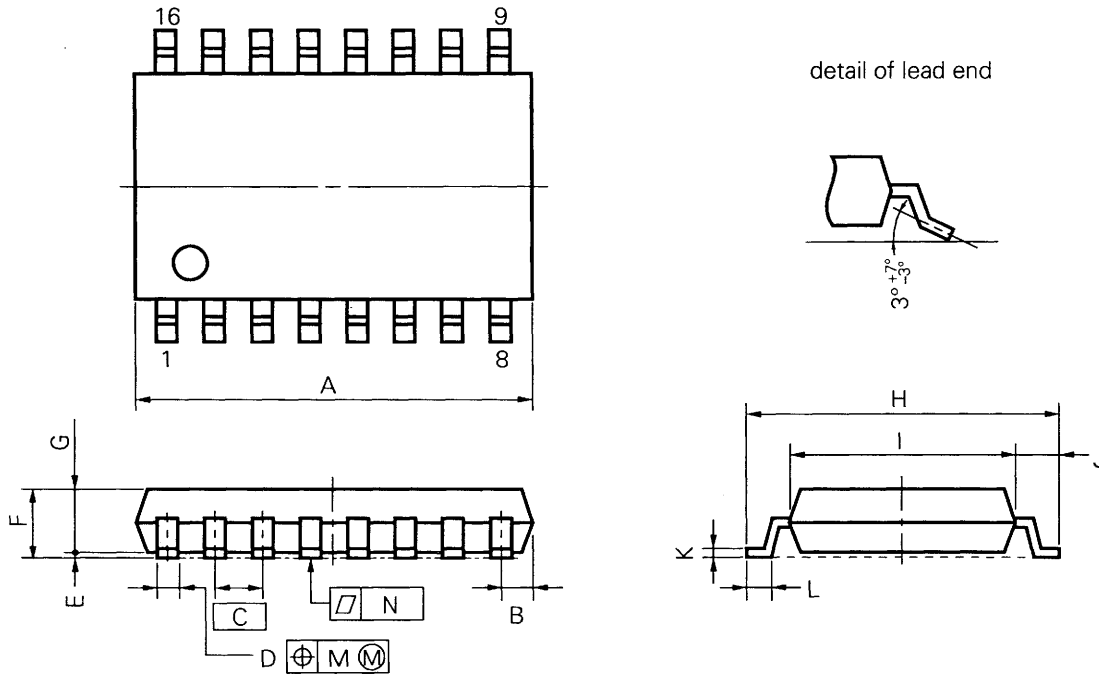

P16GM-50-300B-3

NOTE

Each lead centerline is located within 0.12 mm (0.005 inch) of its true position (T.P.) at maximum material condition.

ITEM	MILLIMETERS	INCHES
A	10.46 MAX.	0.412 MAX.
B	0.78 MAX.	0.031 MAX.
C	1.27 (T.P.)	0.050 (T.P.)
D	0.40 ^{+0.10} _{-0.05}	0.016 ^{+0.004} _{-0.003}
E	0.1±0.1	0.004±0.004
F	1.8 MAX.	0.071 MAX.
G	1.55	0.061
H	7.7±0.3	0.303±0.012
I	5.6	0.220
J	1.1	0.043
K	0.20 ^{+0.10} _{-0.05}	0.008 ^{+0.004} _{-0.002}
L	0.6±0.2	0.024 ^{+0.008} _{-0.009}
M	0.12	0.005
N	0.10	0.004

RECOMMENDED SOLDERING CONDITIONS

The following conditions (see table below) must be met when soldering this product.

Please consult with our sales offices in case other soldering process is used, or in case soldering is done under different conditions.

TYPES OF SURFACE MOUNT DEVICE

For more details, refer to our document "SEMICONDUCTOR DEVICES MOUNTING TECHNOLOGY MANUAL" (IEI-1207).

μPA1602GS

Soldering process	Soldering conditions	Symbol
Infrared ray reflow	Peak package's surface temperature: 235 °C or below, Reflow time: 30 seconds or below (210 °C or higher), Number of reflow process: 2 or below, Exposure limit*: None	IR35-00-2
VPS	Peak package's surface temperature: 215 °C or below, Reflow time: 40 seconds or below (200 °C or higher), Number of reflow process: 2 or below, Exposure limit*: None	VP15-00-2
Wave soldering	Solder temperature: 260 °C or below, Flow time: 10 seconds or below, Number of flow process: 1, Exposure Limit*: None	WS60-00-1

*: Exposure limit before soldering after dry-pack package is opened.

Storage conditions: 25 °C and relative humidity at 65 % or less.

Note: Do not apply more than a single process at once, except for "Partial heating method".

TYPES OF THROUGH HOLE MOUNT DEVICE

μPA1602CX

Soldering process	Soldering conditions	Symbol
Wave soldering	Solder temperature: 260 °C or below, Flow time: 10 seconds or below	

Reference

Document name	Document No.
Quality control of NEC semiconductors devices.	TEI-1202
Quality control guide of semiconductors devices.	MEI-1202
Assembly manual of semiconductors devices.	IEI-1207
Semiconductor device package manual	IEI-1213
SMD surface mount technology manual	IEI-1207

[MEMO]

No part of this document may be copied or reproduced in any form or by any means without the prior written consent of NEC Corporation. NEC Corporation assumes no responsibility for any errors which may appear in this document.

NEC Corporation does not assume any liability for infringement of patents, copyrights or other intellectual property rights of third parties by or arising from use of a device described herein or any other liability arising from use of such device. No license, either express, implied or otherwise, is granted under any patents, copyrights or other intellectual property rights of NEC Corporation or others.

The devices listed in this document are not suitable for use in aerospace equipment, submarine cables, nuclear reactor control systems and life support systems. If customers intend to use NEC devices for above applications or they intend to use "Standard" quality grade NEC devices for applications not intended by NEC, please contact our sales people in advance.

Application examples recommended by NEC Corporation.

Standard: Computer, Office equipment, Communication equipment, Test and Measurement equipment, Machine tools, Industrial robots, Audio and Visual equipment, Other consumer products, etc.

Special: Automotive and Transportation equipment, Traffic control systems, Antidisaster systems, Anticrime systems, etc.