

THC63LVD103D

160MHz 30Bits COLOR LVDS Transmitter

General Description

The THC63LVD103D transmitter is designed to support pixel data transmission between Host and Flat Panel Display from NTSC up to 1080p(60Hz).

The THC63LVD103D converts 35bits of CMOS/TTL data into LVDS(Low Voltage Differential Signaling) data stream. The transmitter can be programmed for rising edge or falling edge clocks through a dedicated pin. At a transmit clock frequency of 160MHz, 30bits of RGB data and 5bits of timing and control data (HSYNC, VSYNC, DE, CNTL1, CNTL2) are transmitted at an effective rate of 1.12Gbps per LVDS channel.

Features

- Wide dot clock range: 8-160MHz suited for NTSC, VGA, SVGA, XGA, SXGA and SXGA+ and 1080p
- PLL requires no external components
- Supports spread spectrum clock generator
- On chip jitter filtering
- Clock edge selectable
- Supports reduced swing LVDS for low EMI
- Power down mode
- Low power single 3.3V CMOS design
- 64pin TQFP
- Pin compatible with THC63LVD103(30bits)

Block Diagram

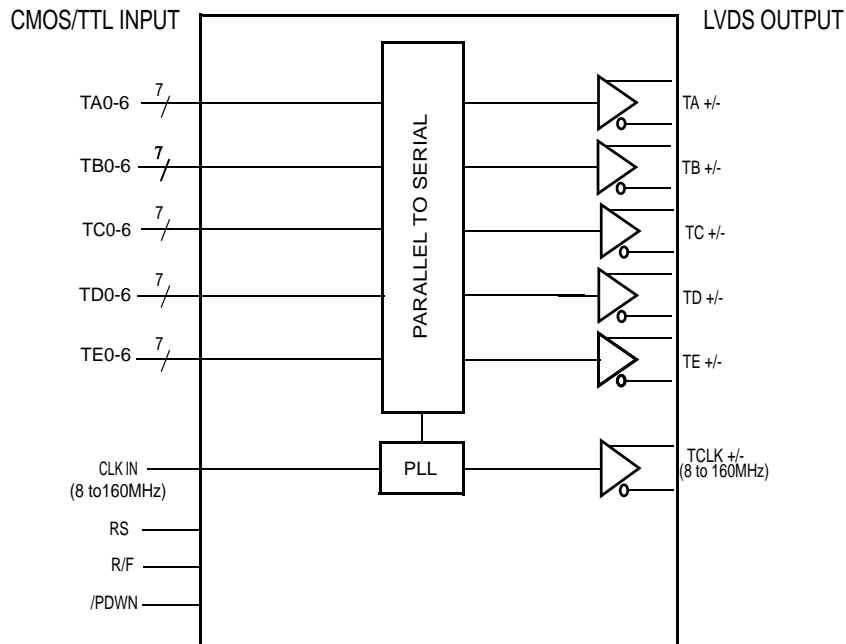

Pin Out

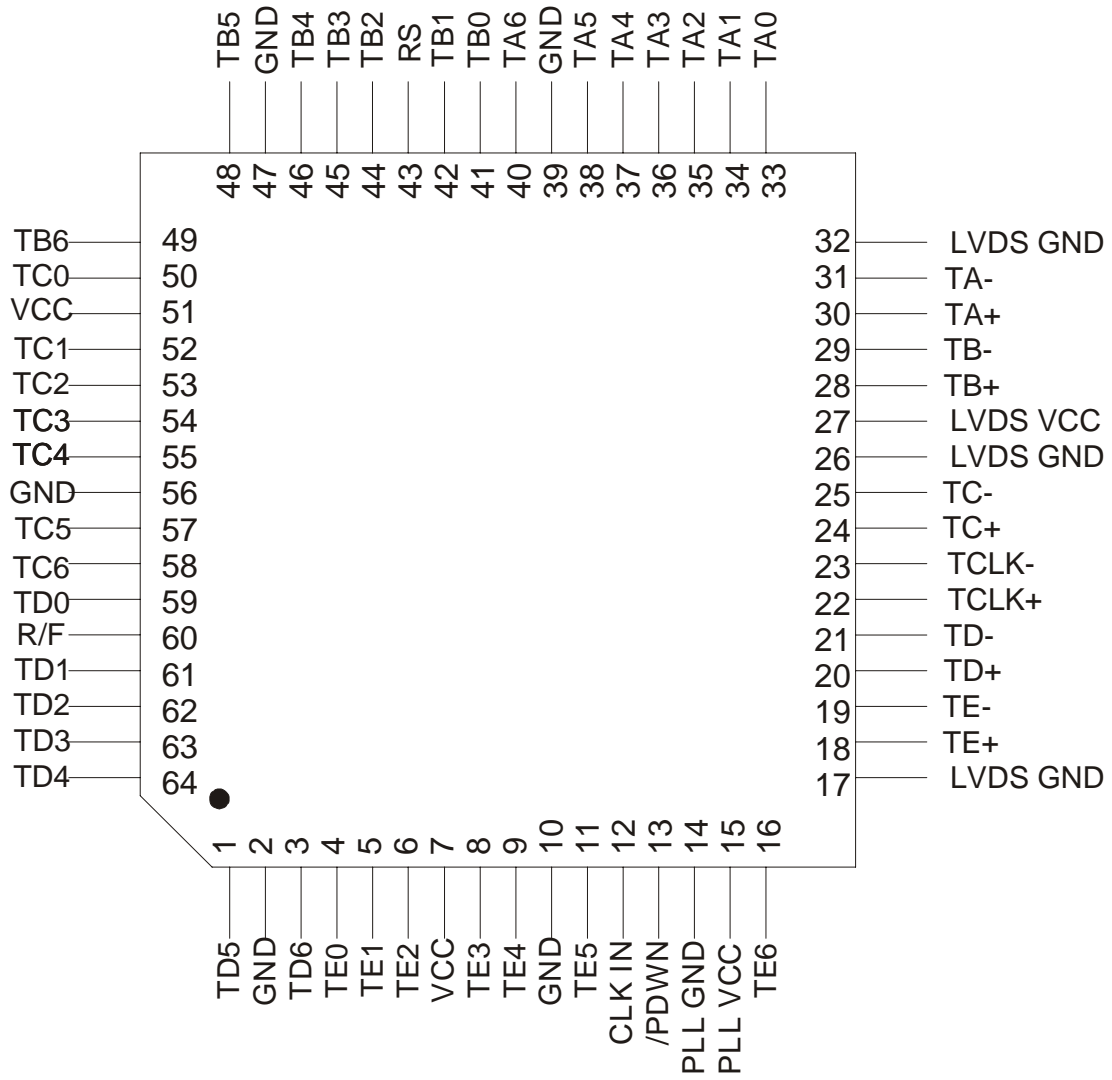

Pin Description

Pin Name	Pin #	Type	Description												
TA+, TA-	30, 31	LVDS OUT	LVDS Data Out.												
TB+, TB-	28, 29	LVDS OUT													
TC+, TC-	24, 25	LVDS OUT													
TD+, TD-	20, 21	LVDS OUT													
TE+, TE-	18, 19	LVDS OUT													
TCLK+, TCLK-	22, 23	LVDS OUT	LVDS Clock Out.												
TA0 ~ TA6	33,34,35,36,37,38,40	IN	Pixel Data Inputs.												
TB0 ~ TB6	41,42,44,45,46,48,49	IN													
TC0 ~ TC6	50,52,53,54,55,57,58	IN													
TD0 ~ TD6	59,61,62,63,64,1,3	IN													
TE0 ~ TE6	4,5,6,8,9,11,16	IN													
/PDWN	13	IN	H: Normal operation, L: Power down (all outputs are Hi-Z)												
RS	43	IN	LVDS swing mode, VREF select. See Fig4, 5. <table border="1" style="margin-left: auto; margin-right: auto;"> <thead> <tr> <th>RS</th> <th>LVDS Swing</th> <th>Small Swing Input Support</th> </tr> </thead> <tbody> <tr> <td>VCC</td> <td>350mV</td> <td>N/A</td> </tr> <tr> <td>0.6 ~ 1.4V</td> <td>350mV</td> <td>RS=VREF^a</td> </tr> <tr> <td>GND</td> <td>200mV</td> <td>N/A</td> </tr> </tbody> </table> <p style="text-align: center; margin-left: 40px;">a. VREF is Input Reference Voltage.</p>	RS	LVDS Swing	Small Swing Input Support	VCC	350mV	N/A	0.6 ~ 1.4V	350mV	RS=VREF ^a	GND	200mV	N/A
RS	LVDS Swing	Small Swing Input Support													
VCC	350mV	N/A													
0.6 ~ 1.4V	350mV	RS=VREF ^a													
GND	200mV	N/A													
R/F	60	IN	Input Clock Triggering Edge Select. H: Rising edge, L: Falling edge												
VCC	51, 7	Power	Power Supply Pins for TTL inputs and digital circuitry.												
CLKIN	12	IN	Clock in.												
GND	2, 10, 39, 47, 56	Ground	Ground Pins for TTL inputs and digital circuitry.												
LVDS VCC	27	Power	Power Supply Pins for LVDS Outputs.												
LVDS GND	17, 26, 32	Ground	Ground Pins for LVDS Outputs.												
PLL VCC	15	Power	Power Supply Pin for PLL circuitry.												
PLL GND	14	Ground	Ground Pins for PLL circuitry.												

Absolute Maximum Ratings¹

Supply Voltage (V_{CC})	-0.3V ~ +4.0V
CMOS/TTL Input Voltage	-0.3V ~ ($V_{CC} + 0.3V$)
CMOS/TTL Output Voltage	-0.3V ~ ($V_{CC} + 0.3V$)
LVDS Transmitter Output Voltage	-0.3V ~ ($V_{CC} + 0.3V$)
Junction Temperature	+125°C
Storage Temperature Range	-55°C ~ +150°C
Reflow Peak Temperature / Time	+260°C / 10sec.
Maximum Power Dissipation @+25°C	2.1W

1. “Absolute Maximum Ratings” are those valued beyond which the safety of the device can not be guaranteed. They are not meant to imply that the device should be operated at these limits. The tables of “Electrical Characteristics” specify conditions for device operation.

Electrical Characteristics

CMOS/TTL DC Specifications

 $V_{CC} = 3.0V \sim 3.6V$, $T_a = 0^{\circ}C \sim +70^{\circ}C$

Symbol	Parameter	Conditions	Min.	Typ.	Max.	Units
V_{IH}	High Level Input Voltage	$RS=V_{CC}$ or GND	2.0		V_{CC}	V
V_{IL}	Low Level Input Voltage	$RS=V_{CC}$ or GND	GND		0.8	V
V_{DDQ}^1	Small Swing Voltage		1.2		2.8	V
V_{REF}	Input Reference Voltage	Small Swing ($RS=V_{DDQ}/2$)		$V_{DDQ}/2$		
V_{SH}^2	Small Swing High Level Input Voltage	$V_{REF} = V_{DDQ}/2$	$V_{DDQ}/2$ +100mV			V
V_{SL}^2	Small Swing Low Level Input Voltage	$V_{REF} = V_{DDQ}/2$			$V_{DDQ}/2$ -100mV	V
I_{INC}	Input Current	$0V \leq V_{IN} \leq V_{CC}$			± 10	μA

Notes: ¹ V_{DDQ} voltage defines max voltage of small swing input. It is not an actual input voltage.² Small swing signal is applied to TA[6:0], TB[6:0], TC[6:0], TD[6:0], TE[6:0] and CLKIN.

LVDS Transmitter DC Specifications

 $V_{CC} = 3.0V \sim 3.6V$, $T_a = 0^{\circ}C \sim +70^{\circ}C$

Symbol	Parameter	Conditions	Min.	Typ.	Max.	Units
VOD	Differential Output Voltage	Normal swing $RS=V_{CC}$ $RL=100\Omega$	250	350	450	mV
		Reduced swing $RS=GND$ $RL=100\Omega$	100	200	300	mV
ΔVOD	Change in VOD between complementary output states	$RL=100\Omega$			35	mV
VOC	Common Mode Voltage		1.125	1.25	1.375	V
ΔVOC	Change in VOC between complementary output states				35	mV
I_{OS}	Output Short Circuit Current	$V_{OUT}=0V$, $RL=100\Omega$			-24	mA
I_{OZ}	Output TRI-STATE Current	/PDWN=0V, $V_{OUT}=0V$ to V_{CC}			± 10	μA

Supply Current

$V_{CC} = 3.0V \sim 3.6V, T_a = 0^{\circ}C \sim +70^{\circ}C$

Symbol	Parameter	Conditions	Typ.	Max.	Units	
I_{TCCW}	Transmitter Supply Current	RL=100Ω, CL=5pF V _{CC} =3.3V, RS=V _{CC} Worst Case Pattern	f=85MHz	69	75	mA
			f=135MHz	87	93	mA
			f=160MHz	97	104	mA
		RL=100Ω, CL=5pF V _{CC} =3.3V, RS=GND Worst Case Pattern	f=85MHz	55	61	mA
			f=135MHz	73	79	mA
			f=160MHz	83	89	mA
I_{TCCS}	Transmitter Power Down Supply Current	/PDWN = L, All Inputs = L or H		10	μA	

Worst Case Pattern

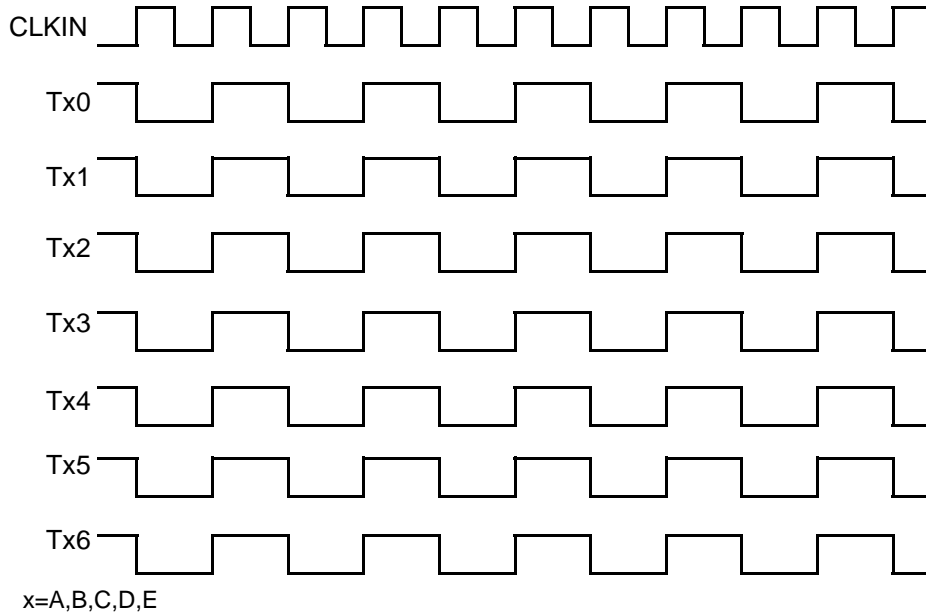

Fig1. Worst Case Pattern

Switching Characteristics

$V_{CC} = 3.0V \sim 3.6V, T_a = 0^{\circ}C \sim +70^{\circ}C$

Symbol	Parameter	Min.	Typ.	Max.	Units
t_{TCIT}	CLK IN Transition time			5.0	ns
t_{TCP}	CLK IN Period	6.25		125.0	ns
t_{TCH}	CLK IN High Time	$0.35t_{TCP}$	$0.5t_{TCP}$	$0.65t_{TCP}$	ns
t_{TCL}	CLK IN Low Time	$0.35t_{TCP}$	$0.5t_{TCP}$	$0.65t_{TCP}$	ns
t_{TCD}	CLK IN to TCLK+/- Delay		$3t_{TCP}$		ns
t_{TS}	TTL Data Setup to CLK IN	2.0			ns
t_{TH}	TTL Data Hold from CKL IN	0.0			ns
t_{LVT}	LVDS Transition Time		0.6	1.5	ns
t_{TOP1}	Output Data Position0 ($t_{TCP}=6.25ns\sim 20ns$)	-0.15	0.0	+0.15	ns
t_{TOP0}	Output Data Position1 ($t_{TCP}=6.25ns\sim 20ns$)	$\frac{t_{TCP}}{7} - 0.15$	$\frac{t_{TCP}}{7}$	$\frac{t_{TCP}}{7} + 0.15$	ns
t_{TOP6}	Output Data Position2 ($t_{TCP}=6.25ns\sim 20ns$)	$2\frac{t_{TCP}}{7} - 0.15$	$2\frac{t_{TCP}}{7}$	$2\frac{t_{TCP}}{7} + 0.15$	ns
t_{TOP5}	Output Data Position3 ($t_{TCP}=6.25ns\sim 20ns$)	$3\frac{t_{TCP}}{7} - 0.15$	$3\frac{t_{TCP}}{7}$	$3\frac{t_{TCP}}{7} + 0.15$	ns
t_{TOP4}	Output Data Position4 ($t_{TCP}=6.25ns\sim 20ns$)	$4\frac{t_{TCP}}{7} - 0.15$	$4\frac{t_{TCP}}{7}$	$4\frac{t_{TCP}}{7} + 0.15$	ns
t_{TOP3}	Output Data Position5 ($t_{TCP}=6.25ns\sim 20ns$)	$5\frac{t_{TCP}}{7} - 0.15$	$5\frac{t_{TCP}}{7}$	$5\frac{t_{TCP}}{7} + 0.15$	ns
t_{TOP2}	Output Data Position6 ($t_{TCP}=6.25ns\sim 20ns$)	$6\frac{t_{TCP}}{7} - 0.15$	$6\frac{t_{TCP}}{7}$	$6\frac{t_{TCP}}{7} + 0.15$	ns
t_{TPLL}	Phase Lock Loop Set			10.0	ms

AC Timing Diagrams TTL Input

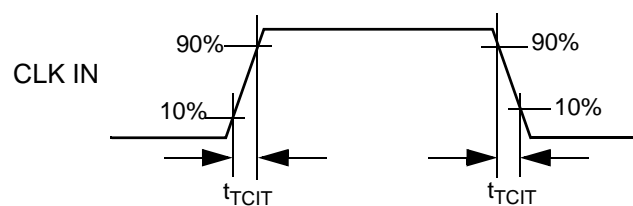

Fig2. CLKIN Transition Time

LVDS Output

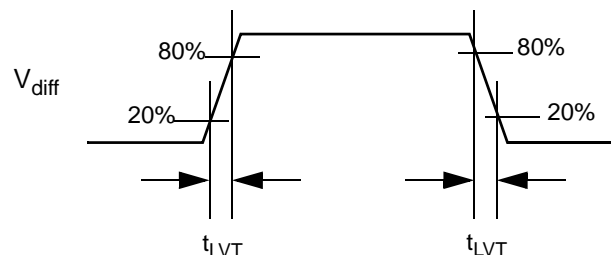
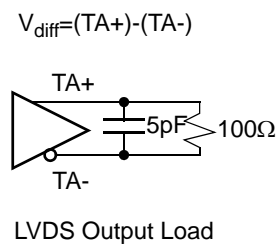
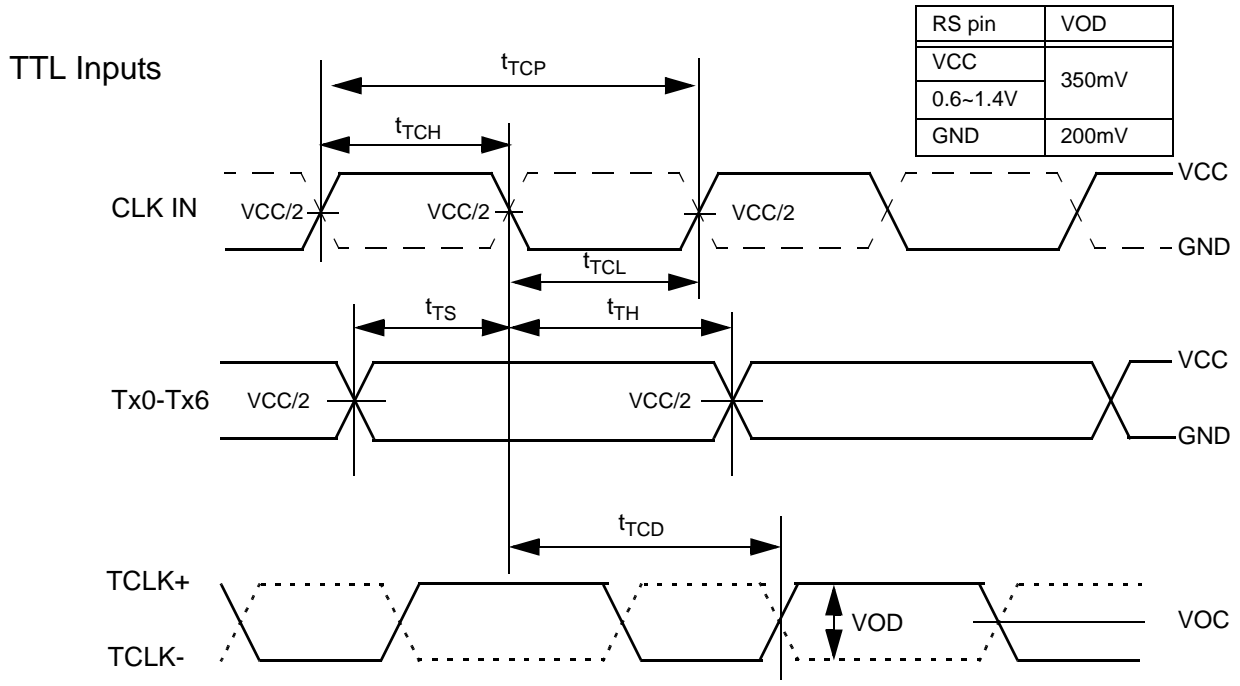

Fig3. LVDS Output Load and Transition Time

AC Timing Diagrams



Note:

CLK IN: for R/F=GND, denote as solid line,
for R/F=VCC, denote as dashed line.

Fig4. CLKIN Period, High/Low Time, Setup/Hold Timing

Small Swing Inputs

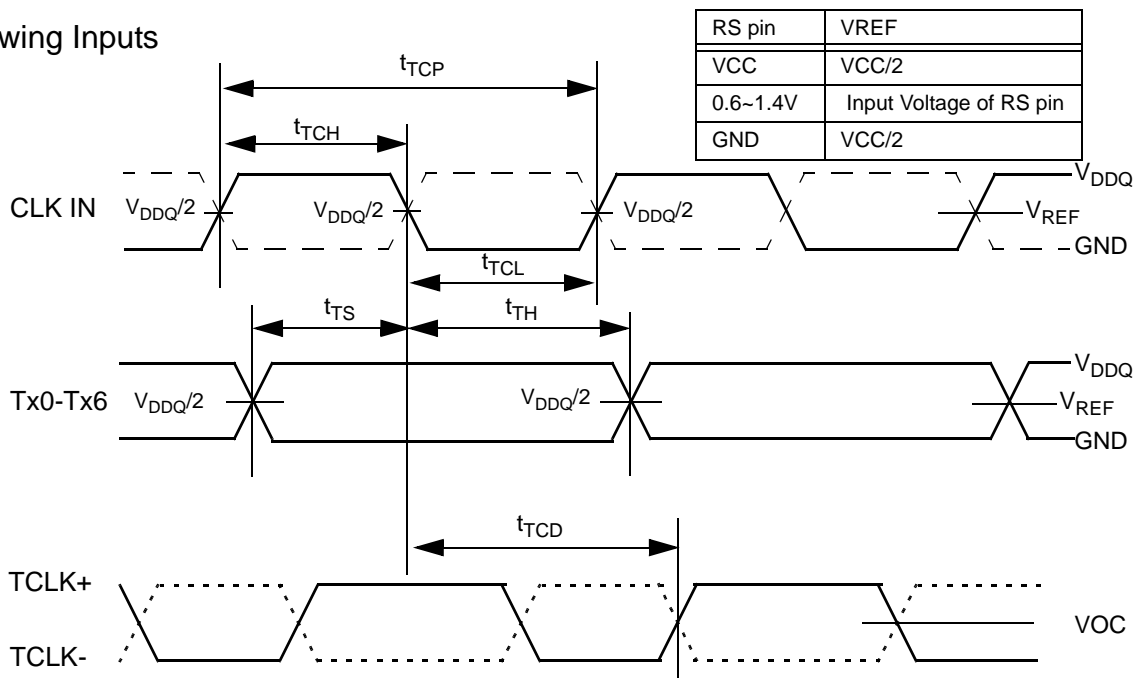

Note:

CLK IN: for R/F=GND, denote as solid line,
for R/F=VCC, denote as dashed line.

Fig5. Small Swing Inputs

AC Timing Diagrams

LVDS Output

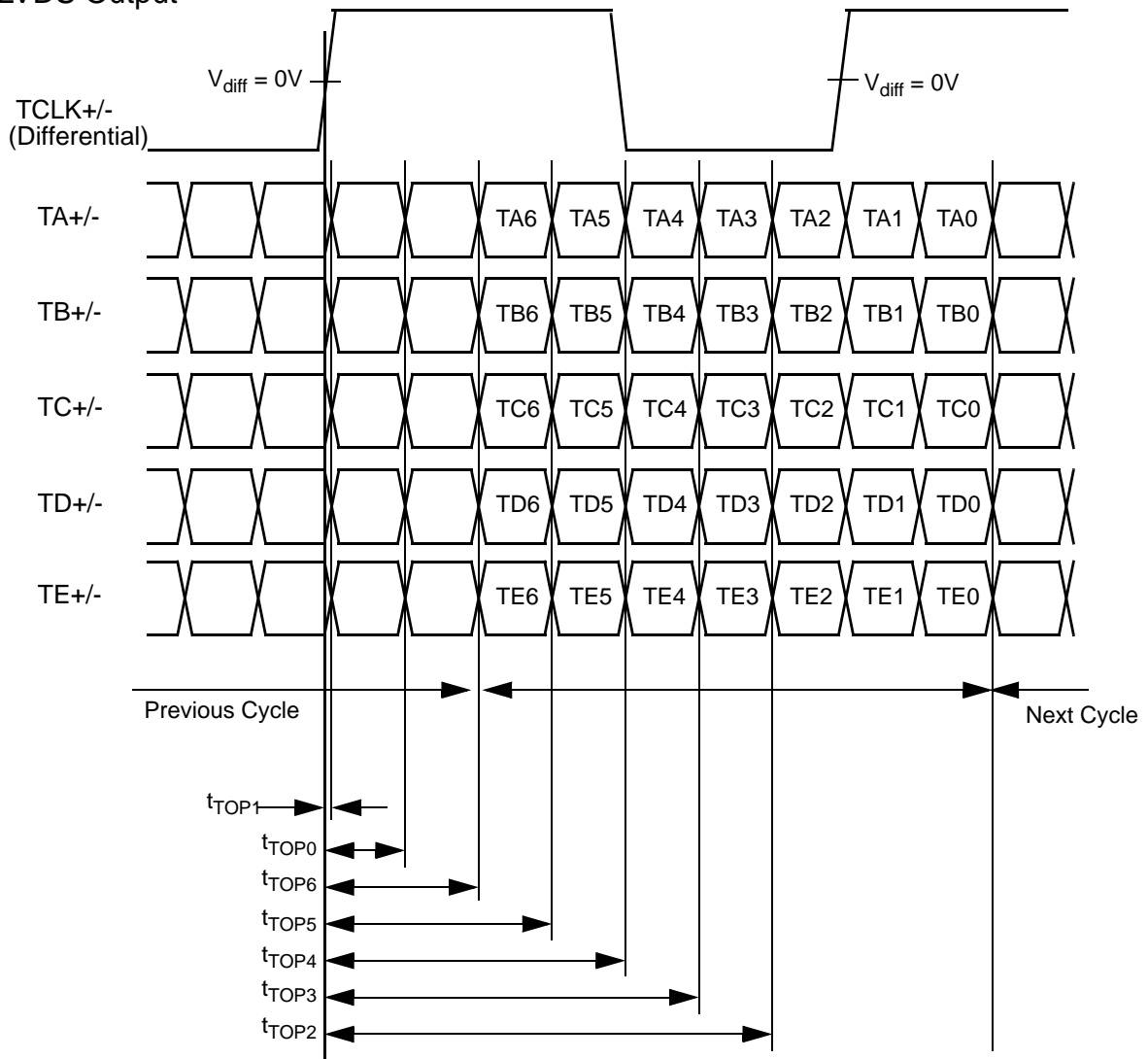

Fig6. LVDS Output Data Position

Phase Lock Loop Set Time

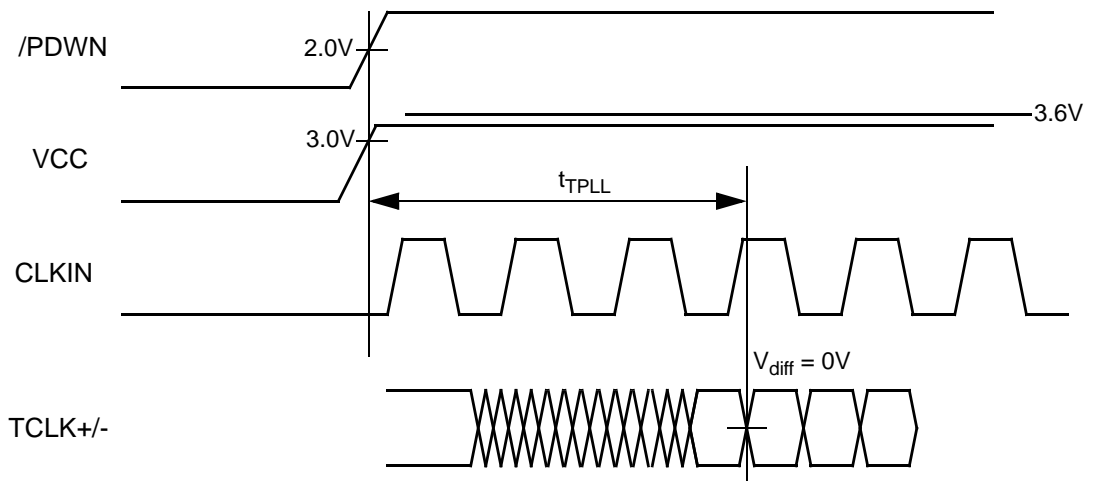

Fig7. PLL Lock Set Time

Note

1)Cable Connection and Disconnection

Don't connect and disconnect the LVDS cable, when the power is supplied to the system.

2)GND Connection

Connect the each GND of the PCB which THC63LVD103D and LVDS-Rx on it. It is better for EMI reduction to place GND cable as close to LVDS cable as possible.

3)Multi Drop Connection

Multi drop connection is not recommended.

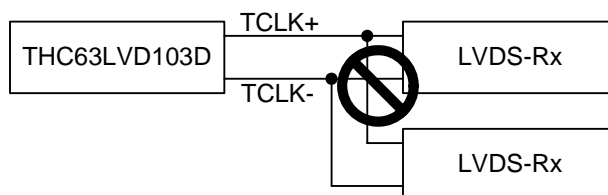

4)Asynchronous use

Asynchronous use such as following systems are not recommended.

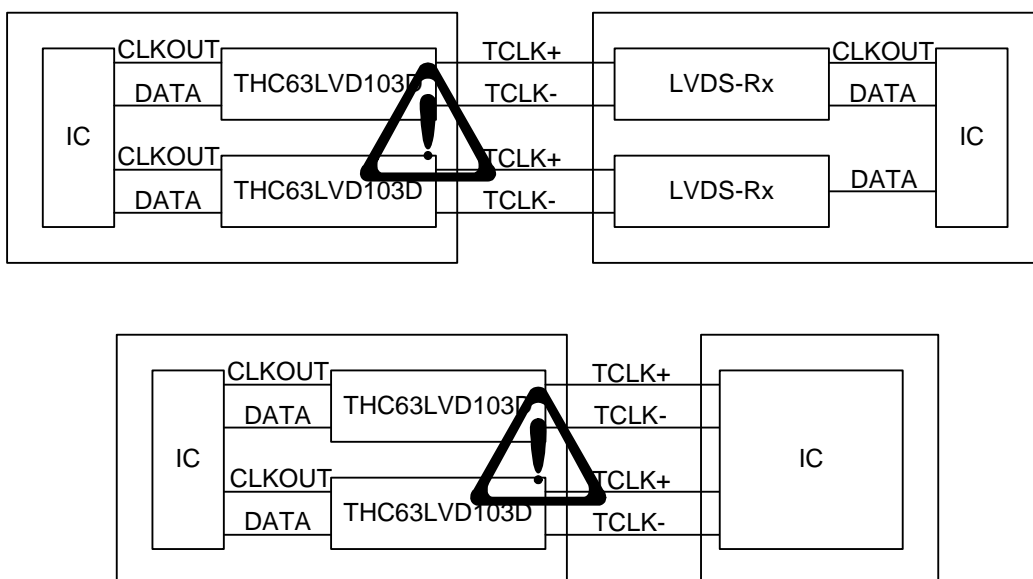

Package

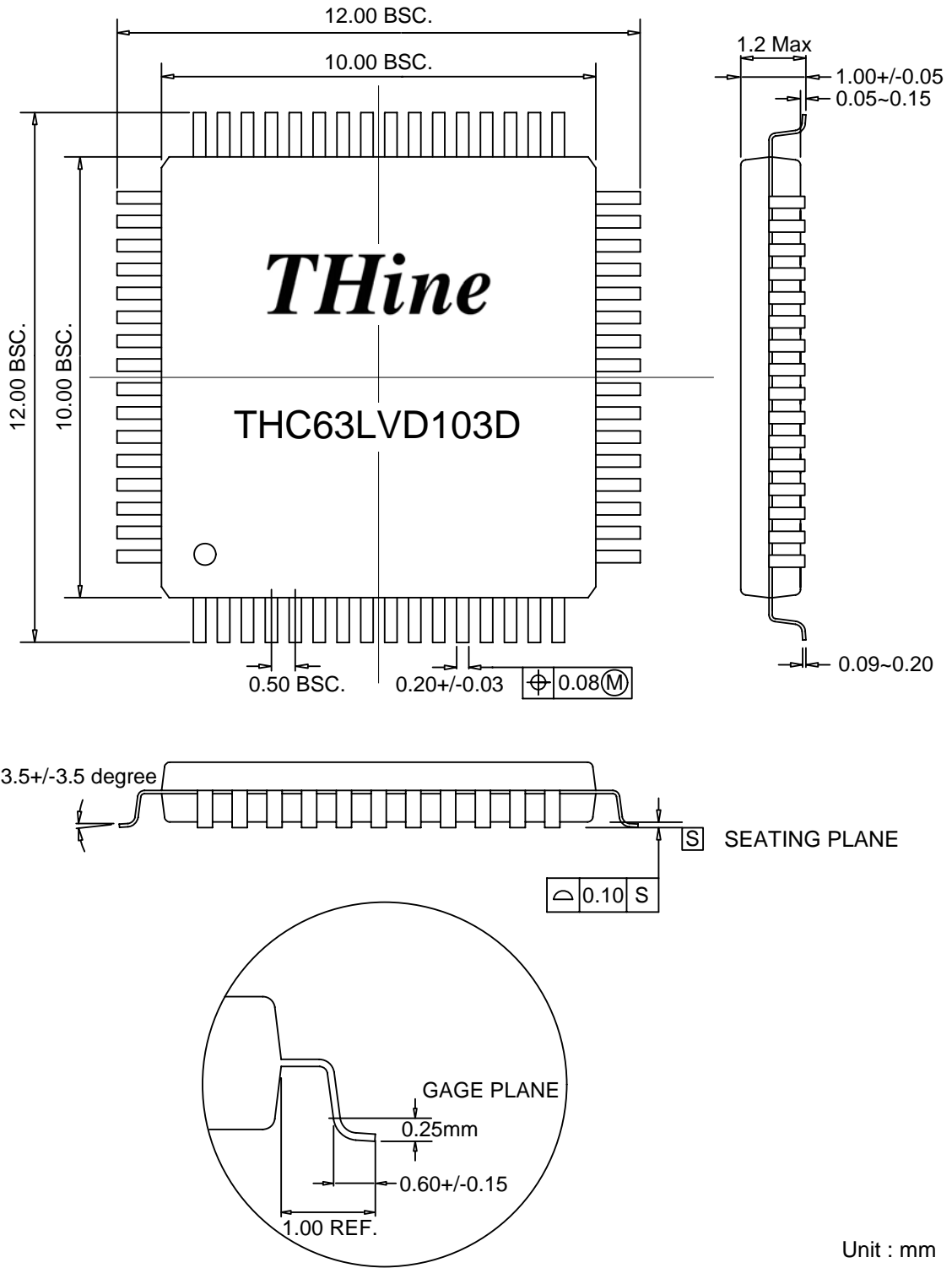

Unit : mm

Notices and Requests

1. The product specifications described in this material are subject to change without prior notice.
2. The circuit diagrams described in this material are examples of the application which may not always apply to the customer's design. We are not responsible for possible errors and omissions in this material. Please note if errors or omissions should be found in this material, we may not be able to correct them immediately.
3. This material contains our copy right, know-how or other proprietary. Copying or disclosing to third parties the contents of this material without our prior permission is prohibited.
4. Note that if infringement of any third party's industrial ownership should occur by using this product, we will be exempted from the responsibility unless it directly relates to the production process or functions of the product.
5. This product is presumed to be used for general electric equipment, not for the applications which require very high reliability (including medical equipment directly concerning people's life, aerospace equipment, or nuclear control equipment). Also, when using this product for the equipment concerned with the control and safety of the transportation means, the traffic signal equipment, or various Types of safety equipment, please do it after applying appropriate measures to the product.
6. Despite our utmost efforts to improve the quality and reliability of the product, faults will occur with a certain small probability, which is inevitable to a semi-conductor product. Therefore, you are encouraged to have sufficiently redundant or error preventive design applied to the use of the product so as not to have our product cause any social or public damage.
7. Please note that this product is not designed to be radiation-proof.
8. Customers are asked, if required, to judge by themselves if this product falls under the category of strategic goods under the Foreign Exchange and Foreign Trade Control Law.

THine Electronics, Inc.

E-mail: sales@thine.co.jp