

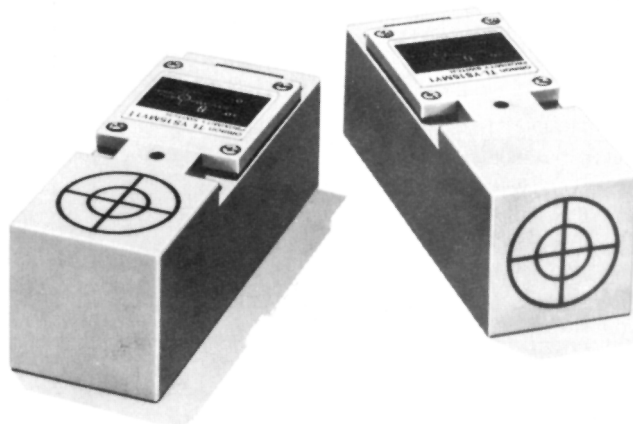

Economical, Limit Switch Style Sensor with Plastic Body

- Low cost
- Wide operating voltages (10 to 30 VDC and 90 to 250 VAC)
- Directly switches AC loads up to 500 mA, DC loads up to 200 mA
- Front, side or end sensing
- DC reverse polarity protection
- Operation indicators, all models



Ordering Information

■ DC THREE-WIRE SENSORS

Type	Sensing distance	Sensing position	Part number	
			NPN-NO	PNP-NO
Unshielded 	15 mm (0.59 in)	End	TL-YS15MC1-US	TL-YS15MB1-US
		Right	TL-YS15MC14-US	TL-YS15MB14-US
		Left	TL-YS15MC12-US	TL-YS15MB12-US
		Front	TL-YS15MC11-US	TL-YS15MB11-US

■ AC TWO-WIRE SENSORS

Type	Sensing distance	Sensing position	Part number	
			SCR-NO	SCR-NC
Unshielded 	15 mm (0.59 in)	End	TL-YS15MY1-US	TL-YS15MY2-US
		Right	TL-YS15MY14-US	TL-YS15MY24-US
		Left	TL-YS15MY12-US	TL-YS15MY22-US
		Front	TL-YS15MY11-US	TL-YS15MY21-US

Specifications

Part number		TL-YS15MB1□-US TL-YS15MC1□-US	TL-YS15MY□□-US	
Sensor Type		Inductive		
Body	Style	Limit Switch		
	Type	Unshielded		
Supply voltage		10 to 30 VDC	90 to 250 VAC, 50/60 Hz	
Current consumption		15 mA max.	1.5 mA max. at 110 VAC 3.0 mA max. at 220 VAC	
Detectable object type		Metallic objects		
Effective maximum detecting distance (with standard target)		15 mm (0.59 in) ±10%		
Usable detecting range (with standard target)		0 to 12 mm (0 to 0.47 in)		
Standard target size (mild steel, L x W x H)		40 x 40 x 1 mm (1.58 x 1.58 x 0.04 in)		
Differential travel		20% max. of effective maximum detecting distance		
Control output	AC solid-state	Type	— SCR-NO (TL-YSMY1□-US) SCR-NC (TL-YSMY2□-US)	
		Max. load	— 500 mA	
		Min. load	— 10 mA	
		Max. off-state leakage current	— See "Leakage Current Characteristics" graph in <i>Engineering Data</i> section	
		Max. on-state voltage drop	— See "Residual Load Voltage Characteristics" graph in <i>Engineering Data</i> section	
	DC solid-state	Type	NPN-NO (TL-YS15MC1□-US) PNP-NO (TL-YS15MB1□-US)	— —
		Max. load	200 mA	—
		Max. on-state voltage drop	1 VDC	—
Response frequency		40 Hz	20 Hz	
Circuit protection	Output short-circuit	Not provided		
	DC power supply reverse polarity	Provided	—	
	Weld field immunity	Not provided		
	RFI immunity	Not provided		
Indicators		Target Present (red LED)	Output operation (red LED)	
Materials	Housing	PF (Phenolic)		
	Sensing face	PF (Phenolic)		
Mounting		Back surface with four through holes		
Connections	Conduit	1/2-14 NPT		
	Wire	Plated steel screw terminals		
Weight		Approx. 180 g (6.4 oz)		
Enclosure ratings	UL	1		
	NEMA	1, 3, 4, 12, 13		
	IEC 144	IP66		
Approvals	UL	—	Listed, File number E76675	
	CSA	—	Certified, File number LR45951	
Ambient operating temperature		-25°C to 70°C (-13° to 158°F)		
Vibration		10 to 55 Hz, 1.5 mm (0.06 in) double amplitude		
Shock		Approx. 50 G		

Operation

■ OUTPUT CIRCUIT DIAGRAM

DC Switching Type

NPN output

TL-YS15MC1□-US

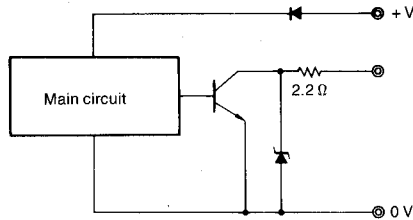

PNP output

TL-YS15MB1□-US

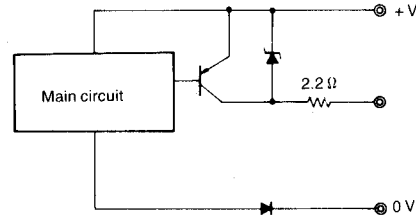

TL-YS15C1□-US

TL-YS15B1□-US

NO

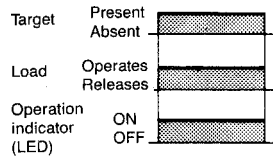

AC Switching Type

TL-YS15MY□□-US

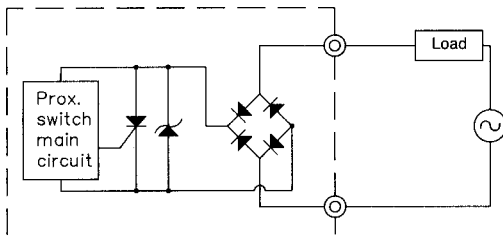

TL-YS15MY1□-US

NO

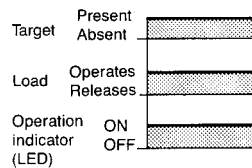

TL-YS15MY2□-US

NC

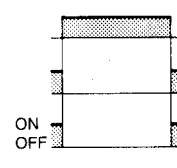

■ CONNECTIONS

DC Switching Types

NPN output

TL-YS15MC1□-US

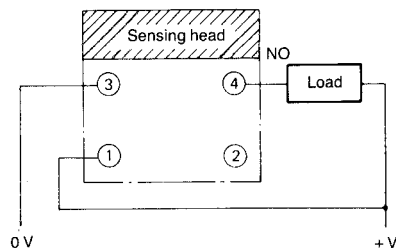

PNP output

TL-YS15MB1□-US

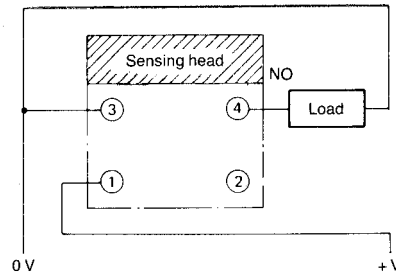

AC Switching Types

TL-YS15MY□□-US

NO or NC operation

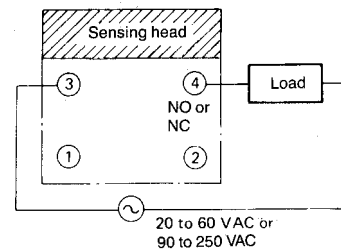

Engineering Data

■ OPERATING RANGE

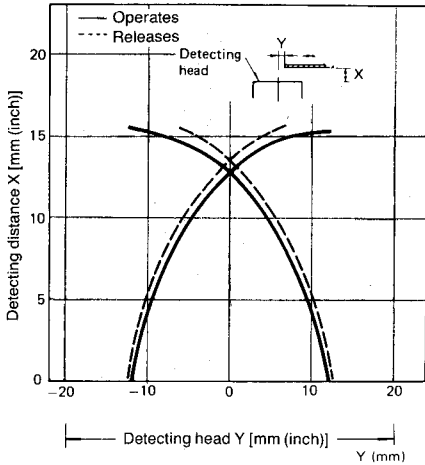

■ DETECTING DISTANCE VS. SIZE OF TARGET

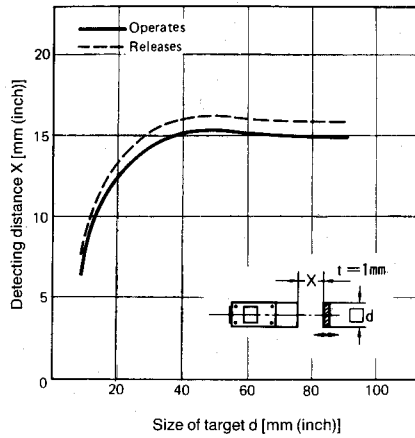

■ DETECTING DISTANCE VS. MATERIAL OF TARGET

Material	Detecting distances
Mild steel	15 mm (0.59 in)
Stainless steel	10 mm (0.39 in)
Brass	6.4 mm (0.25 in)
Aluminum	5 mm (0.20 in)
Copper	5 mm (0.20 in)

Note: Standard target size is 30 x 30 x 1 mm.

Note: If the target is a nonferrous metal, the operating distance of the proximity sensor decreases. However, with a piece of foil measuring about 0.01 mm (0.0004 in) in thickness, the detecting distance is equivalent to that with a ferrous metal. Note that the proximity sensor cannot detect extremely thin evaporated films and non-conductive targets.

■ RESIDUAL LOAD VOLTAGE CHARACTERISTICS

AC Switching Types TL-YS15MY□□-US

110 VAC

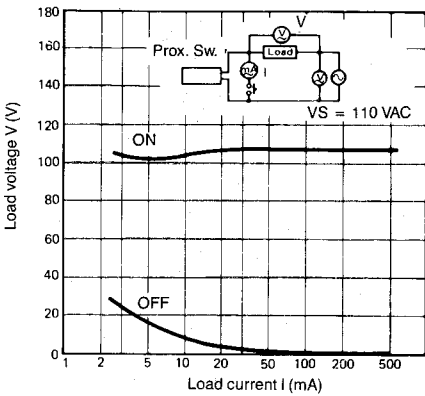

220 VAC

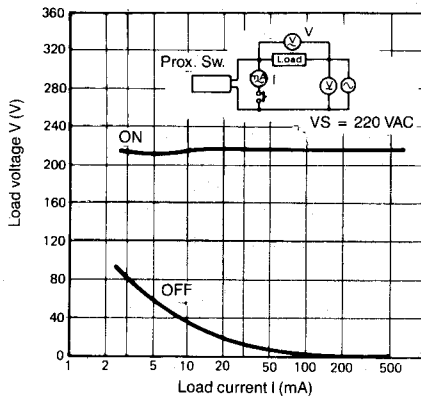

Note: When the current rating of the load is less than 10 mA, false operation may occur. This is normal, and the problem can be solved by installing a bleeder resistor in parallel with the load. Use the formulas given here to calculate the power rating and value of the resistor.

$$R \leq \frac{V_s}{10 - i} \text{ (k}\Omega\text{)} \quad P > \frac{V_s^2}{R} \text{ (mW)}$$

P : Wattage of bleeder resistor
i : Load current (mA)
Vs : Supply voltage (V)

LEAKAGE CURRENT CHARACTERISTICS

AC Switching Types
TL-YS15MY□□-US

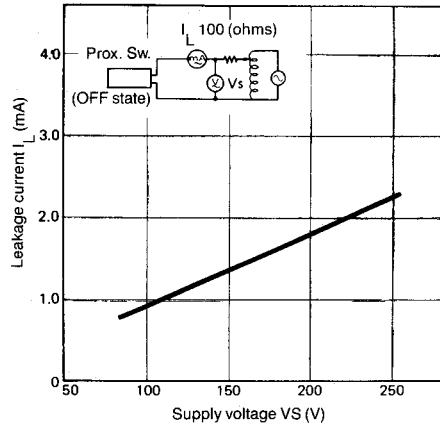

Note: Even when the proximity sensor is in the OFF state, a very small amount of current flows to operate the internal circuit of the sensor. Because of this leakage current, a small voltage is generated in the load, which may occasionally result in improper resetting of the load. Before using the proximity sensor, confirm that this voltage is less than the release voltage value of the load.

Dimensions

Unit: mm (inch)

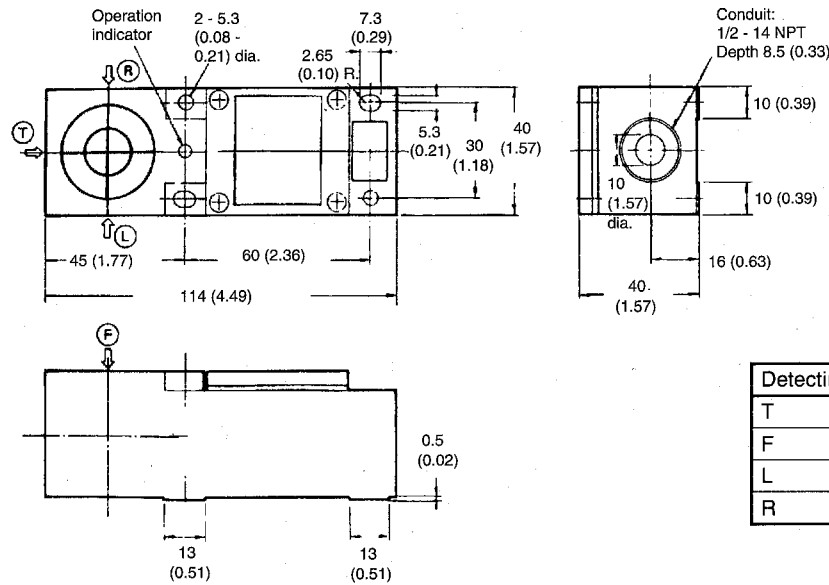

Detecting surface		Part number
T	Top	TL-YS15M□□-US
F	Front	TL-YS15M□□1-US
L	Left	TL-YS15M□□2-US
R	Right	TL-YS15M□□4-US

Precautions

■ EFFECTS OF SURROUNDING METALS

When mounting a proximity sensor flush with a metallic panel, be sure to provide a minimum distance as shown in the table to prevent the sensor from being effected by metallic objects other than the target.

Drawing dimension	Minimum distance mm (inch)
A	45 (1.77)
B	45 (1.77)

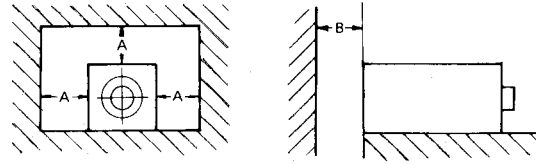

■ MUTUAL INTERFERENCE

To prevent mutual interference, be sure to space the sensors at a distance greater than that shown in the table below.

Drawing dimension	Minimum distance mm (inch)
C	150 (5.91)
D	200 (7.87)

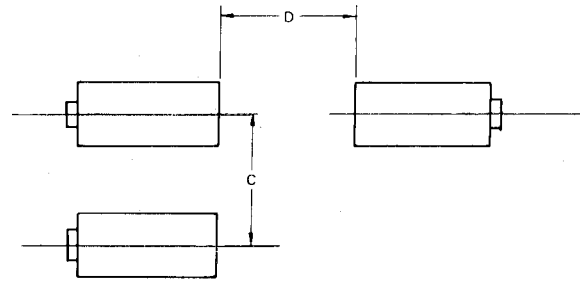

■ INFLUENCE OF PLATING

Metals with different types of plating effect the detecting distance of inductive proximity sensors. The table at right shows reference values for the percentage of the rated detecting distance that may be expected by type of plating materials.

Type of plating	% of detecting distance (of standard unplated iron target)
Zn	100
Cr	75
Ag	60
Ni	70
Cu	70

NOTE: DIMENSIONS ARE SHOWN IN MILLIMETERS. To convert millimeters to inches divide by 25.4.



OMRON ELECTRONICS, INC.
 One East Commerce Drive
 Schaumburg, IL 60173
1-800-55-OMRON

OMRON CANADA, INC.
 885 Milner Avenue
 Scarborough, Ontario M1B 5V8
416-286-6465