

Am54S/74S151·Am54S/74S251

Eight-Input Multiplexers

Distinctive Characteristics

- Advanced Schottky technology
- Switches one of eight inputs to two complementary outputs
- Three-state output on Am54S/74S251 for bus organized systems
- 100% reliability assurance testing in compliance with MIL-STD-883

FUNCTIONAL DESCRIPTION

The Am54S/74S151 and the Am54S/74S251 are eight-input multiplexers that switch one of eight inputs onto the inverting and non-inverting outputs under the control of a three-bit select code. The inverting output is one gate delay faster than the non-inverting output.

The Am54S/74S151 provides an active-LOW strobe. When the strobe is HIGH, the inverting output (W) is HIGH and the non-inverting output (Y) is LOW.

The Am54S/74S251 features a three-state output for data bus organization. The active-LOW strobe, or "output control" applies to both the inverting and non-inverting output. When the output control is HIGH, the outputs are in the high-impedance state. When the output control is LOW, the active pull-up output is enabled.

ORDERING INFORMATION

Package Type	Temperature Range	Am54S/74S151 Order Number	Am54S/74S251 Order Number
Molded DIP	0°C to +70°C	SN74S151N	SN74S251N
Hermetic DIP	0°C to +70°C	SN74S151J	SN74S251J
Dice	0°C to +70°C	SN74S151X	SN74S251X
Hermetic DIP	-55°C to +125°C	SN54S151J	SN54S251J
Hermetic Flat Pak	-55°C to +125°C	SN54S151W	SN54S251W
Dice	-55°C to +125°C	SN54S151X	SN54S251X

LOGIC DIAGRAM

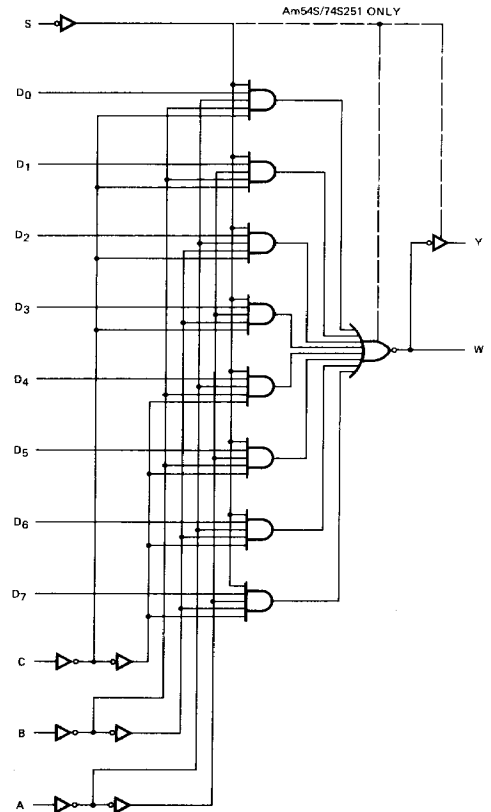

CONNECTION DIAGRAM Top View

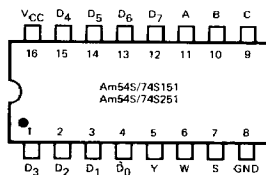

Note: Pin 1 is marked for orientation.

LOGIC SYMBOL

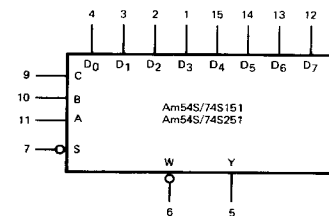

V_{CC} = Pin 16
GND = Pin 8

MAXIMUM RATINGS (Above which the useful life may be impaired).

Storage Temperature	-65°C to +150°C
Temperature (Ambient) Under Bias	-55°C to +125°C
Supply Voltage to Ground Potential (Pin 16 to Pin 8) Continuous	-0.5V to +7V
DC Voltage Applied to Outputs for HIGH Output State	-0.5V to +V _{CC} max.
DC Input Voltage	-0.5V to +5.5V
DC Output Current, Into Output	30mA
DC Input Current	-30mA to +5.0mA

ELECTRICAL CHARACTERISTICS OVER OPERATING TEMPERATURE RANGE (Unless Otherwise Noted)

Parameters	Description	Test Conditions (Note 1)	Min.	Typ. (Note 2)	Max.	Units	
V _{OH}	Output HIGH Voltage	V _{CC} = MIN., V _{IN} = V _{IH} or V _{IL}	I _{OH} = -1mA	2.5	3.4	Volts	
				2.7	3.4		
				I _{OH} = -2mA	2.4		3.4
					I _{OH} = -6.5mA		2.4
V _{OL}	Output LOW Voltage	V _{CC} = MIN., I _{OL} = 20mA V _{IN} = V _{IH} or V _{IL}				0.5	Volts
V _{IH}	Input HIGH Level	Guaranteed input logical HIGH voltage for all inputs	2			Volts	
V _{IL}	Input LOW Level	Guaranteed input logical LOW voltage for all inputs			0.8	Volts	
V _I	Input Clamp Voltage	V _{CC} = MIN., I _{IN} = -18mA			-1.2	Volts	
I _{IL} (Note 3)	Unit Load	V _{CC} = MAX., V _{IN} = 0.5			-2	mA	
	Input LOW Current						
I _{IH} (Note 3)	Unit Load	V _{CC} = MAX., V _{IN} = 2.7V			50	μA	
	Input HIGH Current						
I _I	Input HIGH Current	V _{CC} = MAX., V _{IN} = 5.5V			1	mA	
I _{O(off)}	Off-State (High-Impedance) Output Current (S251 only)	V _{CC} = MAX., V _{IN} = V _{IH} or V _{IL}	V _O = 2.4V		50	μA	
			V _O = 0.5V		-50		
I _{SC}	Output Short Circuit Current (Note 4)	V _{CC} = MAX., V _{OUT} = 0.0V	-40		-100	mA	
I _{CC}	Power Supply Current	V _{CC} = MAX. (Note 5)	S151	45	70	mA	
			S251	55	85		

- Notes: 1. For conditions shown as MIN. or MAX., use the appropriate value specified under Electrical Characteristics for the applicable device type.
 2. Typical limits are at V_{CC} = 5.0V, 25°C ambient and maximum loading.
 3. Actual input currents = Unit Load Current x Input Load Factor (See Loading Rules).
 4. Not more than one output should be shorted at a time. Duration of the short circuit test should not exceed one second.
 5. I_{CC} is measured with all outputs open and all inputs at 4.5V.

Switching Characteristics (T_A = +25°C)

Parameters	Description	Test Conditions	Min.	Typ.	Max.	Units
t _{PLH}	A, B, or C to Y; 4 Levels of Delay (S151 only)	V _{CC} = 5.0V, R _L = 280Ω, C _L = 15 pF		12	18	ns
t _{PHL}				12	18	
t _{PLH}	A, B, or C to Y; 4 Levels of Delay (S251 only)			12	18	ns
t _{PHL}				13	19.5	
t _{PLH}	A, B, or C to W; 3 Levels of Delay			10	15	ns
t _{PHL}				9	13.5	
t _{PLH}	Any D to Y			8	12	ns
t _{PHL}				8	12	
t _{PLH}	Any D to W			4.5	7	ns
t _{PHL}				4.5	7	
t _{PLH}	Strobe to Y (S151 only)			11	16.5	ns
t _{PHL}				12	18	
t _{PLH}	Strobe to W (S151 only)		9	13	ns	
t _{PHL}			8.5	12		
t _{ZH}	Output Enable to Y (S251 only)	V _{CC} = 5.0V, R _L = 280Ω, C _L = 15 pF		13	19.5	ns
t _{ZL}				14	21	
t _{ZH}	Output Enable to W (S251 only)			13	19.5	ns
t _{ZL}				14	21	
t _{HZ}	Output Enable to Y (S251 only)	V _{CC} = 5.0V, R _L = 280Ω, C _L = 5 pF		5.5	8.5	ns
t _{LZ}				9	14	
t _{HZ}	Output Enable to W (S251 only)			5.5	8.5	ns
t _{LZ}				9	14	

FUNCTION TABLE

INPUTS					OUTPUTS			
SELECT			S151 Strobe	S251 Output Control	S151 Output		S251 Output	
C	B	A	S	S	Y	W	Y	W
X	X	X	H	H	L	H	Z	Z
L	L	L	L	L	D ₀	\bar{D}_0	D ₀	\bar{D}_0
L	L	H	L	L	D ₁	\bar{D}_1	D ₁	\bar{D}_1
L	H	L	L	L	D ₂	\bar{D}_2	D ₂	\bar{D}_2
L	H	H	L	L	D ₃	\bar{D}_3	D ₃	\bar{D}_3
H	L	L	L	L	D ₄	\bar{D}_4	D ₄	\bar{D}_4
H	L	H	L	L	D ₅	\bar{D}_5	D ₅	\bar{D}_5
H	H	L	L	L	D ₆	\bar{D}_6	D ₆	\bar{D}_6
H	H	H	L	L	D ₇	\bar{D}_7	D ₇	\bar{D}_7

H = HIGH

X = Don't Care

L = LOW

Z = High Impedance

D₀-D₇ = The output will follow the HIGH-level or LOW-level of the selected input.

\bar{D}_0 - \bar{D}_7 = The output will follow the complement of the HIGH-level or LOW-level of the selected input.

DEFINITION OF FUNCTIONAL TERMS

A, B, C The three select inputs of the multiplexer.

D₀, D₁, D₂, D₃.

D₄, D₅, D₆, D₇ The eight data inputs of the multiplexer.

Y The true multiplexer output.

W The complement multiplexer output.

S Strobe. On the Am54S/74S151, a HIGH on the strobe forces the Y output LOW and the W output HIGH.

S Output Control. On the Am54S/74S251, a HIGH on the output control (or strobe) forces both the W and Y outputs to the high-impedance (off) state.

LOADING RULES (In Unit Loads)

Input/Output	Pin No.'s	Input Unit Load	Output HIGH	Fan-out Output LOW
D ₃	1	1	-	-
D ₂	2	1	-	-
D ₁	3	1	-	-
D ₀	4	1	-	-
Y	5	-	20	10
W	6	-	20	10
S	7	1	-	-
GND	8	-	-	-
C	9	1	-	-
B	10	1	-	-
A	11	1	-	-
D ₇	12	1	-	-
D ₆	13	1	-	-
D ₅	14	1	-	-
D ₄	15	1	-	-
V _{CC}	16	-	-	-

A Schottky TTL Unit Load is defined as 50 μ A measured at 2.7V HIGH and -2.0mA measured at 0.5V LOW.

SCHOTTKY INPUT/OUTPUT CURRENT INTERFACE CONDITIONS

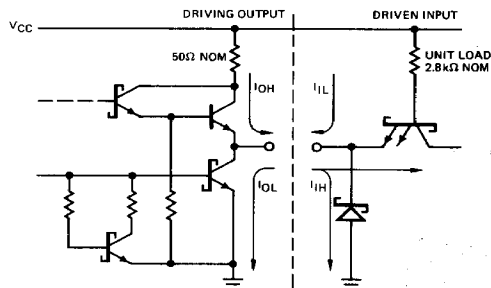

Note: Actual current flow direction shown.

APPLICATIONS

LOGIC FUNCTION GENERATION

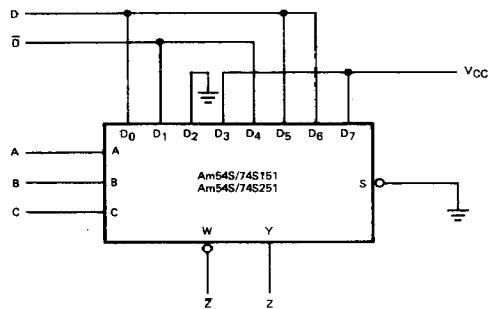

$$Z = \bar{A}\bar{B}CD + \bar{A}BC\bar{D} + A\bar{C}D + AB + AC\bar{D} + B\bar{C}\bar{D}$$

32-INPUT MULTIPLEXER

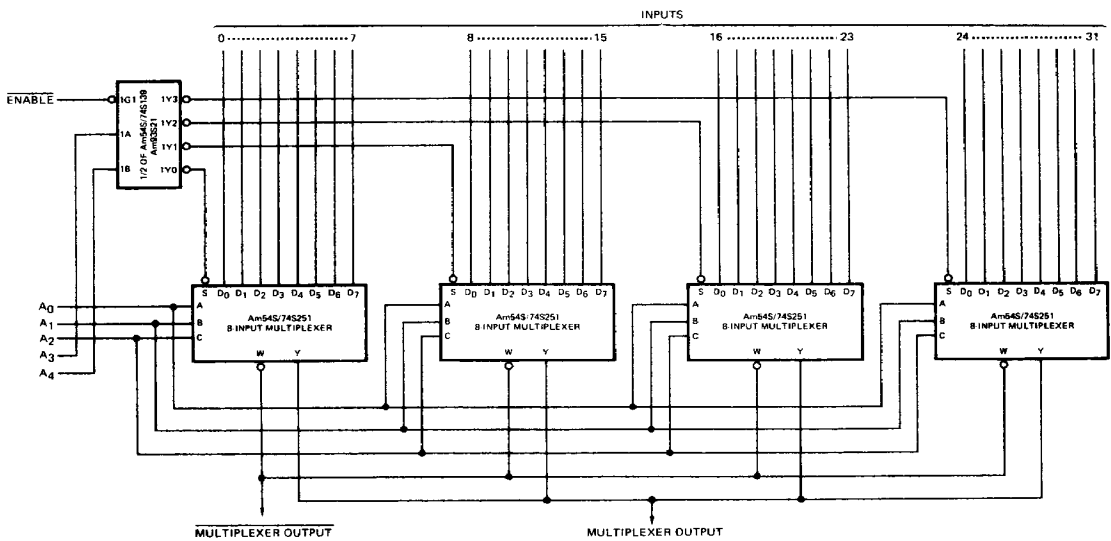

Metallization and Pad Layout

Am54S/74S151

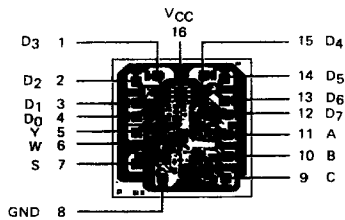

Am54S/74S251

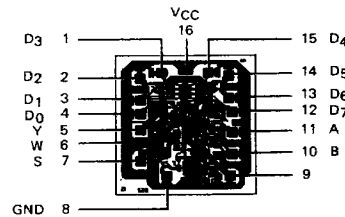

DIE SIZE: 0.064" X 0.067"