

Features

- Dual Complimentary Outputs
- Wide Input Voltage: 38 V to 75 V
- 1,500 VDC Isolation
- 9 Pin DIP Package
- Low-Profile (8mm)
- Pin-compatible with PT4300 Series
- No External Components Required
- Safety Approvals: UL / cUL 60950
EN 60950

Description

The PT4310 modules are a low-power series of isolated DC/DC converters that produce a dual complimentary output. The PT4310 series is pin-compatible with the PT4300 series, and has improved temperature compensation. These modules are an ideal alternative to the PT4300 for both new and existing designs.

Applications include Telecom and Datacom systems where both board space and height are a premium.

The PT4310 series is offered in an open-frame lightweight package, and is available in both through-hole or SMD-DIP package types. Models include the standard output voltages, ± 5 V, ± 12 V, and ± 24 V. The output voltages are adjustable by up to 5%.

Ordering Information

PT4311□	= ± 5 V/1.2 A
PT4313□	= ± 12 V/0.5 A
PT4314□	= ± 24 V/0.25 A

PT Series Suffix (PT1234 x)

Case/Pin Configuration	Order Suffix	Package Code
Horizontal	A	(EGK)
SMD	C	(EGL)

(Reference the applicable package code drawing for the dimensions and PC board layout)

Pin-Out Information

Pin	Function
1	V_{O1} (+)
2	COM
3	V_{O2} (-)
8	N/C
9	N/C
11	Remote On/Off #
12	$\pm V_{out}$ Adjust #
17	-Vin
18	+Vin

Package Top View

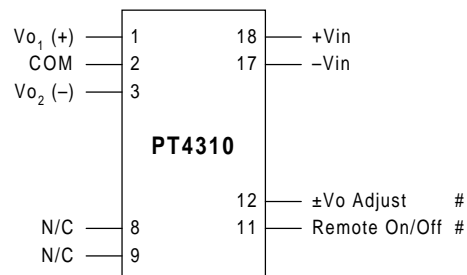

For more information on the Remote On/Off control and output voltage adjustment, refer to the application notes.

Environmental Specifications

Characteristic	Symbol	Conditions	PT4310 Series			Units
			Min	Typ	Max	
Operating Temperature Range	T_a	Over V_{in} range	-40	—	+85 ⁽ⁱ⁾	°C
Solder Reflow Temperature	T_{reflow}	Surface temperature of module, case or pins	—	—	215	°C
Storage Temperature	T_s	—	-40	—	+125	°C
Reliability	MTBF	Per Bellcore TR-332 50% stress, $T_a = 40^\circ\text{C}$, ground benign	4.0	—	—	10^6 Hrs
Mechanical Shock	—	Per Mil-Std-883D, method 2002.3, 1 mS, half-sine, mounted to a fixture	—	500	—	G's
Mechanical Vibration	—	Per Mil-Std-883D, method 2007.2, 20-2000 Hz, soldered in a PC board	—	20	—	G's
Weight	—	—	—	10	—	grams
Flammability	—	Materials meet UL 94V-0	—	—	—	—

Notes: (i) See Safe Operating Area curves or contact the factory for the appropriate derating.

(ii) During solder reflow of SMD package version, do not elevate the module, case, pins, or internal component temperatures above a peak of 215°C. For further guidance refer to the application note, "Reflow Soldering Requirements for Plug-in Power Surface Mount Products," (SLTA051).

Pin Descriptions

+Vin: The positive input supply for the module with respect to $-V_{in}$. When powering the module from a -48-V telecom central office supply, this input is connected to the primary system ground.

-Vin: The negative input supply for the module, and the 0-VDC reference for the 'Remote On/Off' and ' $\pm V_o$ Adjust' control inputs. When the module is powered from a +48-V supply, this input is connected to the input source return.

Remote On/Off: This is an open-collector (open-drain) negative logic input that enables the module output. The input is referenced to $-V_{in}$. Applying a low-level ground signal to this pin disables the module's outputs. A high impedance enables the module's outputs. If not used the pin should be left unconnected.

V_{o1}: The positive regulated power output voltage, which is referenced to the COM node.

V_{o2}: The negative regulated power output voltage, which is referenced to the COM node.

COM: The secondary return reference for the module's two regulated output voltages. It is dc isolated from the +Vin and -Vin input supply pins.

$\pm V_o$ Adjust: Using a single resistor, this pin allows the module's complementary output voltages to be adjusted higher or lower than their preset value. If not used, this pin should be left open circuit. Consult the related application note for further information.

Specifications (Unless otherwise stated, $T_a = 25^\circ\text{C}$, $V_{in} = 53\text{ V}$, $C_{out} = 0\text{ }\mu\text{F}$, and $I_{O1} = |I_{O2}| = I_{Otyp}$)

Characteristic	Symbol	Conditions	PT4310 Series			Units				
			Min	Typ	Max					
Output Power	$P_{O(tot)}$		—	—	6	W				
Output Current	$I_{O1}, I_{O2} $ ⁽¹⁾	Over V_{in} range (any one output)	PT4311 ($\pm 5\text{ V}$) PT4313 ($\pm 12\text{ V}$) PT4314 ($\pm 24\text{ V}$)	0.2 ⁽²⁾ 0.05 ⁽²⁾ 0.02 ⁽²⁾	0.6 0.25 0.125	1 0.45 0.125	A			
	$I_{O1} + I_{O2} $ ⁽¹⁾	Over V_{in} range (sum-total from both outputs)	PT4311 PT4313 PT4314	0.4 0.1 0.04	— — —	1.2 0.5 0.25	A			
Input Voltage Range	V_{in}	Over I_o range	38	—	75	V				
Set Point Voltage	$V_{O1}, V_{O2} $ ⁽¹⁾		PT4311 PT4313 PT4314	4.95 11.85 23.28	5.05 12 24	5.15 12.15 24.72	V			
		Temperature Variation	Reg_{temp}	$-40 > T_a > +85^\circ\text{C}$	PT4311 PT4313 PT4314	— — —	± 0.5 ± 1 ± 1	— — —	%V	
Line Regulation	Reg_{line}	Over V_{in} range	—	± 25	± 40	—	mV			
Load Regulation	Reg_{load}	$ I_{Ox} = 0.6\text{ A}, 0.2\text{ A} \leq I_{Oy} \leq 0.6\text{ A}$	PT4311	—	100	150	mV			
		$ I_{Ox} = 0.25\text{ A}, 0.05\text{ A} \leq I_{Oy} \leq 0.25\text{ A}$	PT4313	—	250	350				
		$ I_{Ox} = 0.125\text{ A}, 0.02\text{ A} \leq I_{Oy} \leq 0.125\text{ A}$	PT4314	—	275	500				
Total Output Voltage Variation	ΔV_{Otot}	Over V_{in} and load range $-40^\circ\text{C} > T_a > +85^\circ\text{C}$	PT4311, PT4314 PT4313	— —	± 5 ± 4	— —	% V_o			
No-load Output Voltage	$V_{O(no-load)}$	$I_{O1} = I_{O2} = 0$	PT4311 PT4313 PT4314	— — —	5.4 12.7 24.8	5.9 17 29	V			
Efficiency	η		PT4311 PT4313 PT4314	— — —	82 85 82	— — —	%			
		V_o Ripple (pk-pk)	V_r	20 MHz bandwidth	PT4311	—		50	100	mV _{pp}
					PT4313, PT4314	—		90	150	
Transient Response	t_{tr}	$20\% \leq I_{Ox} \leq 75\%$ of I_{Otyp} , 25% load step $ I_{Ox} $	PT4311	—	250	—	μs			
			ΔV_{tr}	$ V_{Ox} $ over/undershoot	PT4311	—		± 75	—	mV
					PT4313 PT4314	— —		± 200 ± 500	— —	
Output Voltage Adjust Range	$\Delta \pm V_{o\ adj}$	Both outputs adjusted simultaneously	—	5	—	—	% V_o			
Current Limit Threshold	I_{Llim}	Over V_{in} range, $\Delta V_o = 10\% V_{o\ nom}$	PT4311, PT4313 PT4314	— —	2.5 0.4	— —	A			
			Short Circuit Current	I_{sc}	PT4311, PT4313 PT4314	— —		1 0.25	— —	A
Inrush Current	I_{ir} t_{ir}	On start-up		—	0.5 1	— —	A ms			
			Switching Frequency	f_o	Over V_{in} range	400		—	520	kHz
Under-Voltage Lockout	UVLO		—	36	—	—	V			
Remote On/Off (Pin 11)	Input High Voltage Input Low Voltage Input Low Current	Referenced to $-V_{in}$ (pin 17)	V_{IH}	5	—	Open ⁽³⁾	V			
			V_{IL}	-0.1	—	+1				
			I_{IL}	—	-0.2	—		mA		
Standby Input Current	$I_{in\ standby}$	pins 11 & 17 connected	—	10	—	—	mA			
Internal Input Capacitance	C_{in}		—	1	—	—	μF			
External Output Capacitance	C_{out}	Sum-total capacitance, connected from both outputs to COM (pin 2)	PT4311	0	—	120 ⁽⁴⁾	μF			
			PT4313	0	—	47 ⁽⁴⁾				
			PT4314	0	—	20 ⁽⁴⁾				
Isolation Voltage Capacitance Resistance		Input - output		1500	—	—	V pF M Ω			
				—	1100	—				
				10	—	—				

- Notes:** (1) $|I_{O2}|$ and $|V_{O2}|$ indicates the magnitudes of the negative output parameters. Parameters within vertical brackets are quoted absolute.
(2) The DC/DC converter will operate at no load with reduced specifications. See "No-load Output Voltage" specification.
(3) The Remote On/Off (pin 11) has an internal pull-up. If the pin is left open the module will operate when input power is applied. Refer to the application notes for interface considerations.
(4) Output capacitors are not required for proper operation. If added, Oscon® or tantalum types are recommended for operation below 0°C ambient.

PT4311 (±5V) Characteristic Data (See Note A)

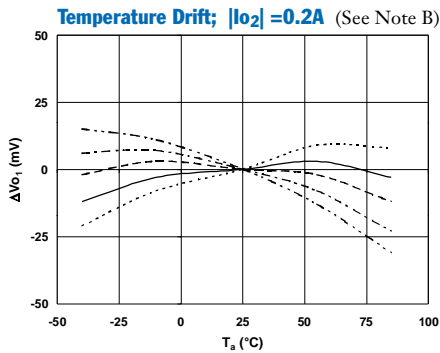
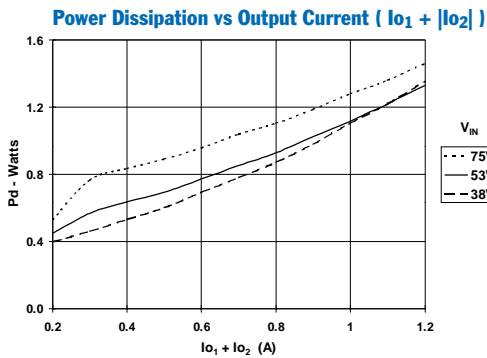
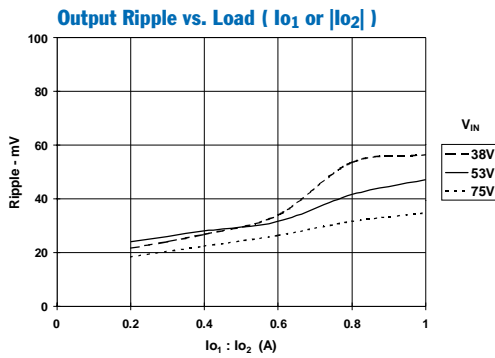
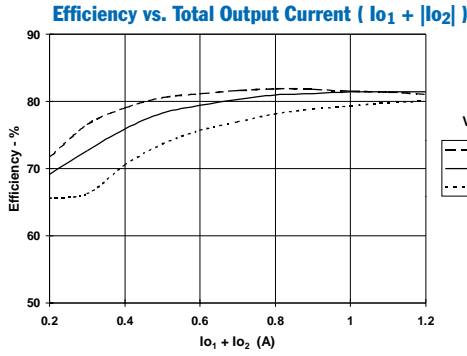

PT4313 (±12V) Characteristic Data (See Note A)

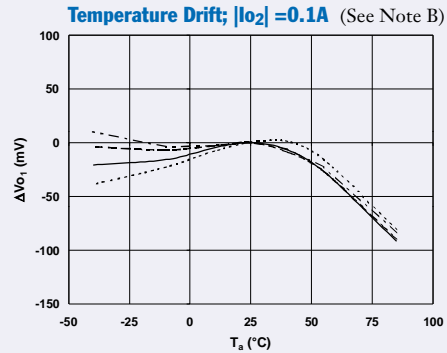
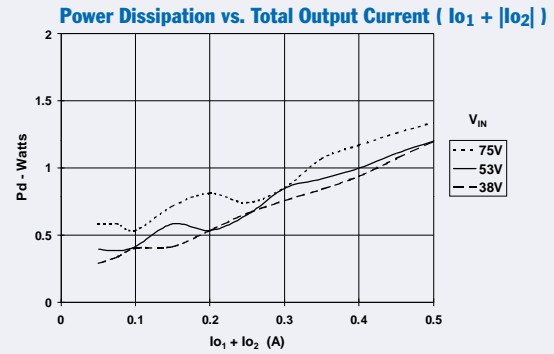
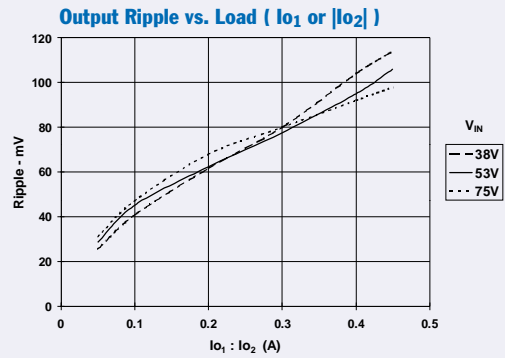
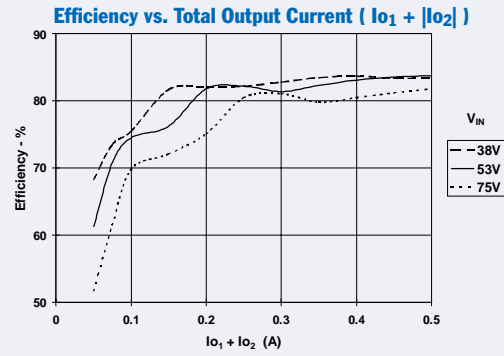

Note A: Characteristic data has been developed from actual products tested at 25°C. This data is considered typical data for the Converter.
Note B: Drift with temperature is normalized to the static output voltage measured at 25°C.

PT4311 (± 5 V) Characteristic Data (See Note A)

Load Regulation, V_{Ox} vs I_{Ox} with $I_{Oy} = 0.2$ A & $V_{IN} = 53$ V

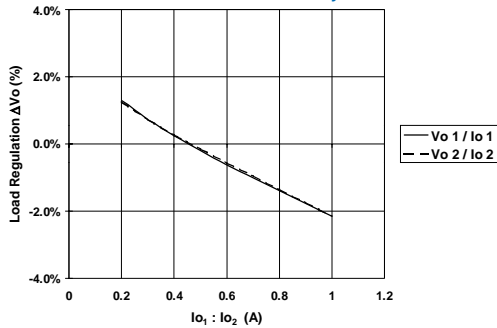

Cross Regulation, V_{Ox} vs I_{Oy} with $I_{Ox} = 0.2$ A & $V_{IN} = 53$ V

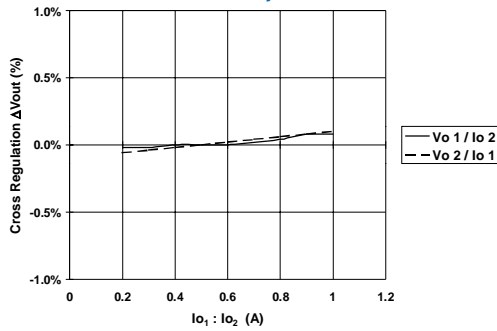

PT4313 (± 12 V) Characteristic Data (See Note A)

Load Regulation, V_{Ox} vs I_{Ox} with $I_{Oy} = 0.05$ A & $V_{IN} = 53$ V

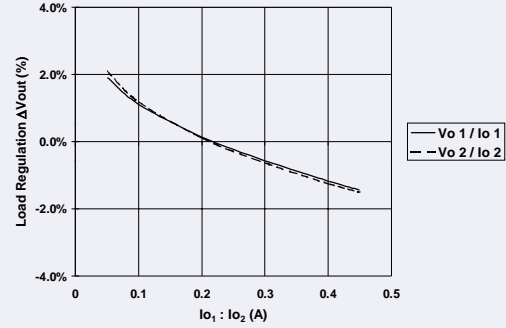

Cross Regulation, V_{Ox} vs I_{Oy} with $I_{Ox} = 0.05$ A & $V_{IN} = 53$ V

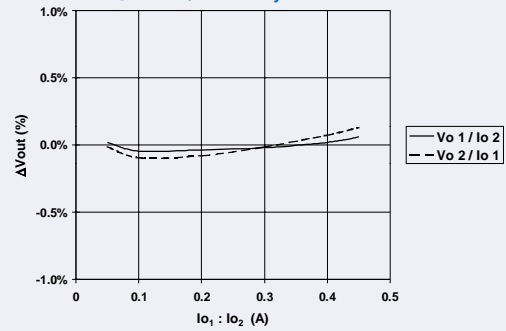

PT4311 Safe Operating Area Curves (See Note C)

$I_{O1} = 0$ to 1 A, $|I_{O2}| = 0.2$ A, $V_{IN} = 38-75$ V

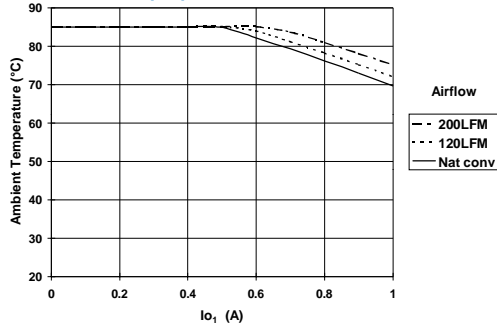

PT4313 Safe Operating Area Curves (See Note C)

$I_{O1} = 0$ to 0.25 A, $|I_{O2}| = 0.25$ A, $V_{IN} = 38-75$ V

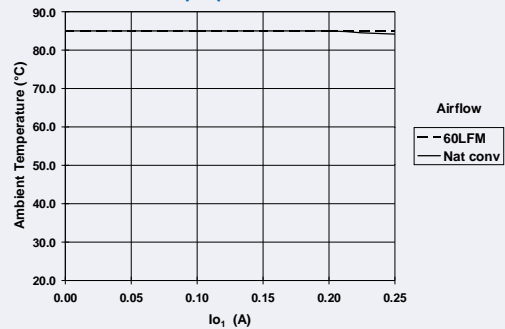

PT4311; $I_{O1} = 0$ to 0.6 A, $|I_{O2}| = 0.6$ A

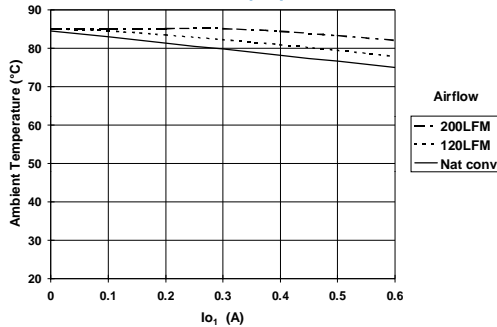

PT4313; $I_{O1} = 0$ to 0.45 A, $|I_{O2}| = 0.05$ A

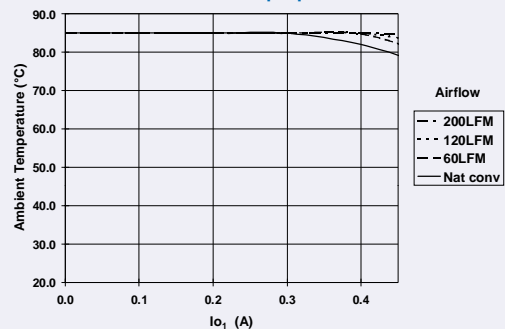

Note A: The above characteristic data has been developed from actual products tested at 25°C and $V_{IN} = 53$ V. This data is considered typical data for the converter.
Note C: SOA curves represent operating conditions at which internal components are at or below manufacturer's maximum rated operating temperatures.

PT4314 (± 24 V) Characteristic Data (See Note A)

Load Regulation, V_{O1} vs I_{O1} with $|I_{O2}| = 0.02$ A

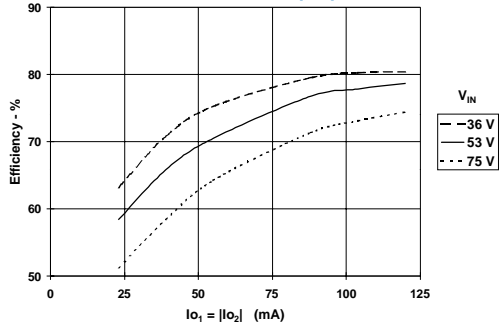

PT 4314 Safe Operating Area Curves (See Note C)

$I_{O1} = |I_{O2}|$ from 0 to 125 mA, $V_{IN} = 53$ V

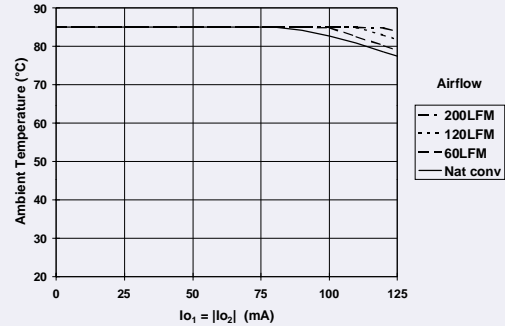

Power Dissipation vs Output Current ($I_{O1} = |I_{O2}|$)

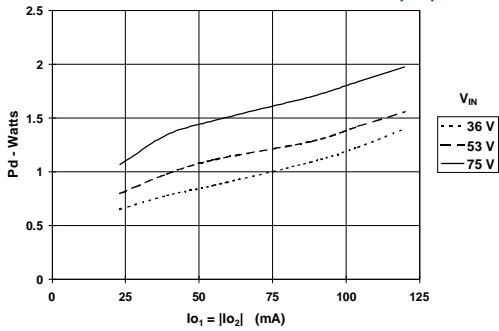

Load Regulation, V_{Ox} vs I_{Ox} with $I_{Oy} = 0.02$ A & $V_{IN} = 53$ V

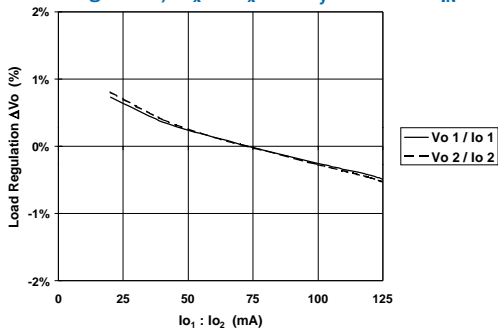

Cross Regulation, V_{Ox} vs I_{Oy} with $I_{Ox} = 0.02$ A & $V_{IN} = 53$ V

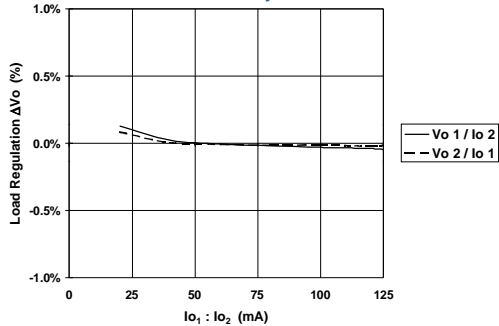

Note A: The above characteristic data has been developed from actual products tested at 25°C and $V_{IN} = 53$ V. This data is considered typical data for the converter.
Note C: SOA curves represent operating conditions at which internal components are at or below manufacturer's maximum rated operating temperatures.

Adjusting the Output Voltage of the PT4310 Series of Isolated DC/DC Converters

The PT4310 is a series of 6-watt isolated dual-output DC/DC converters. The PT4310 series is functionally similar and pin-compatible with the former PT4300 series, but the adjustment of the output voltages is different ¹.

The $\pm V_o$ output voltages of the PT4310 series may be adjusted higher or lower than the factory trimmed value. The adjustment method uses a single external resistor to adjust the magnitude of both output voltages by as much as $\pm 5\%$. When adjusting the output voltages to a lower value, an external bias voltage, referenced to the $-V_{in}$ (primary), is also required. ²

Figure 1-1 gives a suggested schematic for the PT4310 output voltage adjustment. The components (R₃) and (VR₁) are only required with (R₁). ³

Adjust Up: Add a resistor, R₂, between V_o Adjust (pin 12) and $-V_{in}$ (pin 17).

Adjust Down: An increase in the $\pm V_{out}$ output voltages is obtained by adding a resistor, (R₁), between V_o Adjust (pin 12) and a +5 VDC external voltage source. The voltage source must be referenced to $-V_{in}$ (pin 17). A simple external voltage source may be implemented by adding the components (R₃) and (VR₁) in Figure 1-1.

Refer to Table 1-1 for the value of the external adjust resistors, R₂, or (R₁) required to adjust each model of the PT4310 series, up or down respectively by the stated percentage. See Figure 1-1 for the placement of (R₁), R₂, and other components.

Table 1-1

DC/DC CONVERTER ADJUSTMENT RESISTOR VALUES			
Series Pt #	PT4311	PT4313	PT4314
V _o (nom)	± 5 V	± 12 V	± 24 V
(I _{o1} + I _{o2}) max ⁴	1.2 A	0.5 A	0.25 mA
$\pm V_o$ % Adjust			
-5.0%	(90.9 k Ω)	(0 k Ω)	(220 k Ω)
-2.5%	(750 k Ω)	(511 k Ω)	(950 k Ω)
0.0%			
+2.5%	750 k Ω	511 k Ω	950 k Ω
+5.0%	90.9 k Ω	0 k Ω	220 k Ω

R1 = (Blue) R2 = Black

Figure 1-1

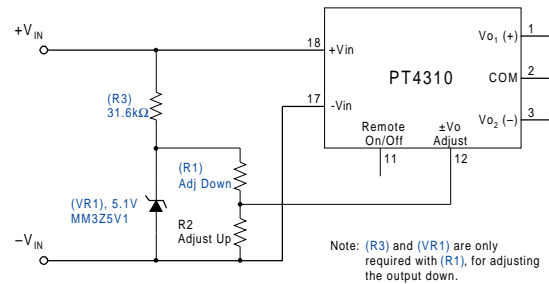

Notes

- In most stand-alone applications the PT4310 series is a direct substitute for the PT4300 series. However, the method of output voltage adjustment differs between the two series. For existing applications that use a PT4300 part, a modification to the circuit will be necessary if the output voltage is required to be adjusted to a value other than the pre-trimmed factory setting.
- The adjustment control input, V_o Adjust (pin 12) is referenced to $-V_{in}$ (pin 17).
- (R₃) and (VR₁) provide a +5 VDC external bias voltage that is required for (R₁) to adjust the output voltages down. If the outputs are to be adjusted up, only the R₂ is required.
- The PT4310 series is rated for 6 watts total output. An increase in the output voltage will require a corresponding reduction in the maximum allowed total output current (I_{o1} + |I_{o2}|) max in Table 1-1. The total current from both outputs must comply with the following equation:-

$$I_{o1} + |I_{o2}| = \frac{6}{V_a} \text{ A dc} \quad \text{or} \quad (I_{o1} + |I_{o2}|)_{\text{max}},$$

whichever is less.

Where, V_a = the new (adjusted) output voltage.

Using the Remote On/Off Function on the PT4310 Isolated Dual Output DC/DC Converters

For applications requiring output voltage On/Off control, the PT4310 DC/DC converter series incorporates a “Remote On/Off” control (pin 11). This feature can be used when there is a requirement for the module to be switched off without removing the applied input source voltage.

The converter operates normally with Pin 11 open-circuit, and produces a regulated output voltage when a valid source voltage is applied to $+V_{in}$ (pin 18), with respect to $-V_{in}$ (pin 17). When a low-level 1 ground signal is applied to pin 11, the converter output will be turned off.

Figure 2-1 shows an application schematic, which details the typical use of the Remote On/Off function. Note the discrete transistor (Q_1). The control pin has its own internal pull-up, and must be controlled with an open-collector or open-drain device (See notes 2 & 3). Table 2-1 gives the input requirements.

When placed in the “Off” state, the standby current drawn from the input source is typically reduced to less than 1 mA.

Table 2-1; Remote On/Off Control Requirements¹

Parameter	Min	Typ	Max
Disable	-0.1 V	—	1 V
Enable	5 V ³	—	Open-Circuit ²
$V_{O/C}$ [Open-Circuit]	—	—	10 V
I_{in} [pin 11 at $-V_{in}$]	—	-200 μ A	—

Notes:

- The Remote On/Off control uses $-V_{in}$ (pin 17) as its ground reference. All voltages specified are with respect to $-V_{in}$.
- Use an open-collector device (preferably a discrete transistor) for the Remote On/Off input. Do not connect a pull-up resistor directly to pin 11.
- The Remote On/Off pin may be controlled with devices that have a totem-pole output providing that a blocking diode is used. The blocking diode is required to prevent current from being injected into On/Off control pin. *Note: For TTL devices a pull-up may be required on the cathode side of the blocking diode. This is to guarantee a minimum enable voltage at pin 11 (See Figure 2-1).*
- The PT4310 converters incorporate an “Under-Voltage Lockout” (UVLO). The UVLO will keep the module off when the input voltage to the converter is low, regardless of the state of the Remote On/Off control. Table 2-2 gives the UVLO input voltage thresholds.

Table 2-2; UVLO Thresholds⁴

Series	V_{in} Range	UVLO Threshold
PT4310	38 – 75 V	36 \pm 2 V

Figure 2-1

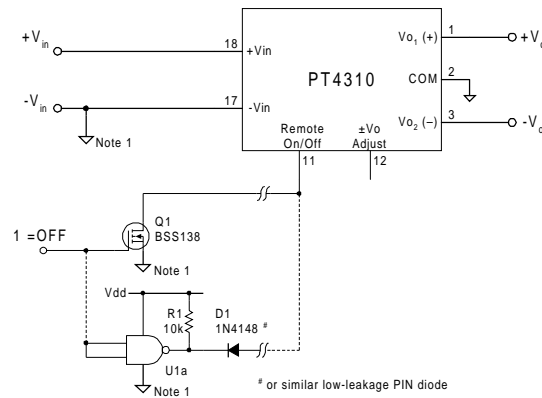

Turn-On Time: In the circuit of Figure 2-1, turning Q_1 on applies a low-voltage to pin 11 and disables the converter output. Correspondingly, turning Q_1 off allows the converter to power up and produce a regulated output voltage within 50 ms. Although the rise-time of the output is short (<1ms), the delay time will vary depending upon the input voltage and the module’s internal timing. Figure 2-2 shows response of the +5-V output from the PT4311 (\pm 5 V), following the turn-off of Q_1 at time $t = 0$. The waveform was measured with a 48 Vdc input voltage, and 0.25-Adc resistive load at both the positive and negative outputs.

Figure 2-2

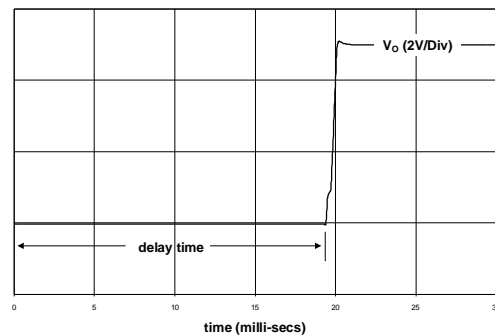

PACKAGING INFORMATION

Orderable Device	Status ⁽¹⁾	Package Type	Package Drawing	Pins	Package Qty	Eco Plan ⁽²⁾	Lead/Ball Finish	MSL Peak Temp ⁽³⁾
PT4311A	NRND	DIP MOD ULE	EGK	9	18	TBD	Call TI	Level-1-215C-UNLIM
PT4311C	NRND	DIP MOD ULE	EGL	9	18	TBD	Call TI	Level-1-215C-UNLIM
PT4313A	NRND	DIP MOD ULE	EGK	9	18	TBD	Call TI	Level-1-215C-UNLIM
PT4313C	NRND	DIP MOD ULE	EGL	9	18	TBD	Call TI	Level-1-215C-UNLIM
PT4314A	NRND	DIP MOD ULE	EGK	9	18	TBD	Call TI	Level-1-215C-UNLIM
PT4314C	NRND	DIP MOD ULE	EGL	9	18	TBD	Call TI	Level-1-215C-UNLIM

⁽¹⁾ The marketing status values are defined as follows:

ACTIVE: Product device recommended for new designs.

LIFEBUY: TI has announced that the device will be discontinued, and a lifetime-buy period is in effect.

NRND: Not recommended for new designs. Device is in production to support existing customers, but TI does not recommend using this part in a new design.

PREVIEW: Device has been announced but is not in production. Samples may or may not be available.

OBSOLETE: TI has discontinued the production of the device.

⁽²⁾ Eco Plan - The planned eco-friendly classification: Pb-Free (RoHS), Pb-Free (RoHS Exempt), or Green (RoHS & no Sb/Br) - please check <http://www.ti.com/productcontent> for the latest availability information and additional product content details.

TBD: The Pb-Free/Green conversion plan has not been defined.

Pb-Free (RoHS): TI's terms "Lead-Free" or "Pb-Free" mean semiconductor products that are compatible with the current RoHS requirements for all 6 substances, including the requirement that lead not exceed 0.1% by weight in homogeneous materials. Where designed to be soldered at high temperatures, TI Pb-Free products are suitable for use in specified lead-free processes.

Pb-Free (RoHS Exempt): This component has a RoHS exemption for either 1) lead-based flip-chip solder bumps used between the die and package, or 2) lead-based die adhesive used between the die and leadframe. The component is otherwise considered Pb-Free (RoHS compatible) as defined above.

Green (RoHS & no Sb/Br): TI defines "Green" to mean Pb-Free (RoHS compatible), and free of Bromine (Br) and Antimony (Sb) based flame retardants (Br or Sb do not exceed 0.1% by weight in homogeneous material)

⁽³⁾ MSL, Peak Temp. -- The Moisture Sensitivity Level rating according to the JEDEC industry standard classifications, and peak solder temperature.

Important Information and Disclaimer: The information provided on this page represents TI's knowledge and belief as of the date that it is provided. TI bases its knowledge and belief on information provided by third parties, and makes no representation or warranty as to the accuracy of such information. Efforts are underway to better integrate information from third parties. TI has taken and continues to take reasonable steps to provide representative and accurate information but may not have conducted destructive testing or chemical analysis on incoming materials and chemicals. TI and TI suppliers consider certain information to be proprietary, and thus CAS numbers and other limited information may not be available for release.

In no event shall TI's liability arising out of such information exceed the total purchase price of the TI part(s) at issue in this document sold by TI to Customer on an annual basis.

IMPORTANT NOTICE

Texas Instruments Incorporated and its subsidiaries (TI) reserve the right to make corrections, modifications, enhancements, improvements, and other changes to its products and services at any time and to discontinue any product or service without notice. Customers should obtain the latest relevant information before placing orders and should verify that such information is current and complete. All products are sold subject to TI's terms and conditions of sale supplied at the time of order acknowledgment.

TI warrants performance of its hardware products to the specifications applicable at the time of sale in accordance with TI's standard warranty. Testing and other quality control techniques are used to the extent TI deems necessary to support this warranty. Except where mandated by government requirements, testing of all parameters of each product is not necessarily performed.

TI assumes no liability for applications assistance or customer product design. Customers are responsible for their products and applications using TI components. To minimize the risks associated with customer products and applications, customers should provide adequate design and operating safeguards.

TI does not warrant or represent that any license, either express or implied, is granted under any TI patent right, copyright, mask work right, or other TI intellectual property right relating to any combination, machine, or process in which TI products or services are used. Information published by TI regarding third-party products or services does not constitute a license from TI to use such products or services or a warranty or endorsement thereof. Use of such information may require a license from a third party under the patents or other intellectual property of the third party, or a license from TI under the patents or other intellectual property of TI.

Reproduction of TI information in TI data books or data sheets is permissible only if reproduction is without alteration and is accompanied by all associated warranties, conditions, limitations, and notices. Reproduction of this information with alteration is an unfair and deceptive business practice. TI is not responsible or liable for such altered documentation. Information of third parties may be subject to additional restrictions.

Resale of TI products or services with statements different from or beyond the parameters stated by TI for that product or service voids all express and any implied warranties for the associated TI product or service and is an unfair and deceptive business practice. TI is not responsible or liable for any such statements.

TI products are not authorized for use in safety-critical applications (such as life support) where a failure of the TI product would reasonably be expected to cause severe personal injury or death, unless officers of the parties have executed an agreement specifically governing such use. Buyers represent that they have all necessary expertise in the safety and regulatory ramifications of their applications, and acknowledge and agree that they are solely responsible for all legal, regulatory and safety-related requirements concerning their products and any use of TI products in such safety-critical applications, notwithstanding any applications-related information or support that may be provided by TI. Further, Buyers must fully indemnify TI and its representatives against any damages arising out of the use of TI products in such safety-critical applications.

TI products are neither designed nor intended for use in military/aerospace applications or environments unless the TI products are specifically designated by TI as military-grade or "enhanced plastic." Only products designated by TI as military-grade meet military specifications. Buyers acknowledge and agree that any such use of TI products which TI has not designated as military-grade is solely at the Buyer's risk, and that they are solely responsible for compliance with all legal and regulatory requirements in connection with such use.

TI products are neither designed nor intended for use in automotive applications or environments unless the specific TI products are designated by TI as compliant with ISO/TS 16949 requirements. Buyers acknowledge and agree that, if they use any non-designated products in automotive applications, TI will not be responsible for any failure to meet such requirements.

Following are URLs where you can obtain information on other Texas Instruments products and application solutions:

Products

Amplifiers	amplifier.ti.com
Data Converters	dataconverter.ti.com
DLP® Products	www.dlp.com
DSP	dsp.ti.com
Clocks and Timers	www.ti.com/clocks
Interface	interface.ti.com
Logic	logic.ti.com
Power Mgmt	power.ti.com
Microcontrollers	microcontroller.ti.com
RFID	www.ti-rfid.com
RF/IF and ZigBee® Solutions	www.ti.com/lprf

Applications

Audio	www.ti.com/audio
Automotive	www.ti.com/automotive
Broadband	www.ti.com/broadband
Digital Control	www.ti.com/digitalcontrol
Medical	www.ti.com/medical
Military	www.ti.com/military
Optical Networking	www.ti.com/opticalnetwork
Security	www.ti.com/security
Telephony	www.ti.com/telephony
Video & Imaging	www.ti.com/video
Wireless	www.ti.com/wireless

Mailing Address: Texas Instruments, Post Office Box 655303, Dallas, Texas 75265
Copyright © 2009, Texas Instruments Incorporated