

# OPTOTRONIC®

Technical Guide

June 2006

Electronic  
Power Supplies  
for LED-Modules

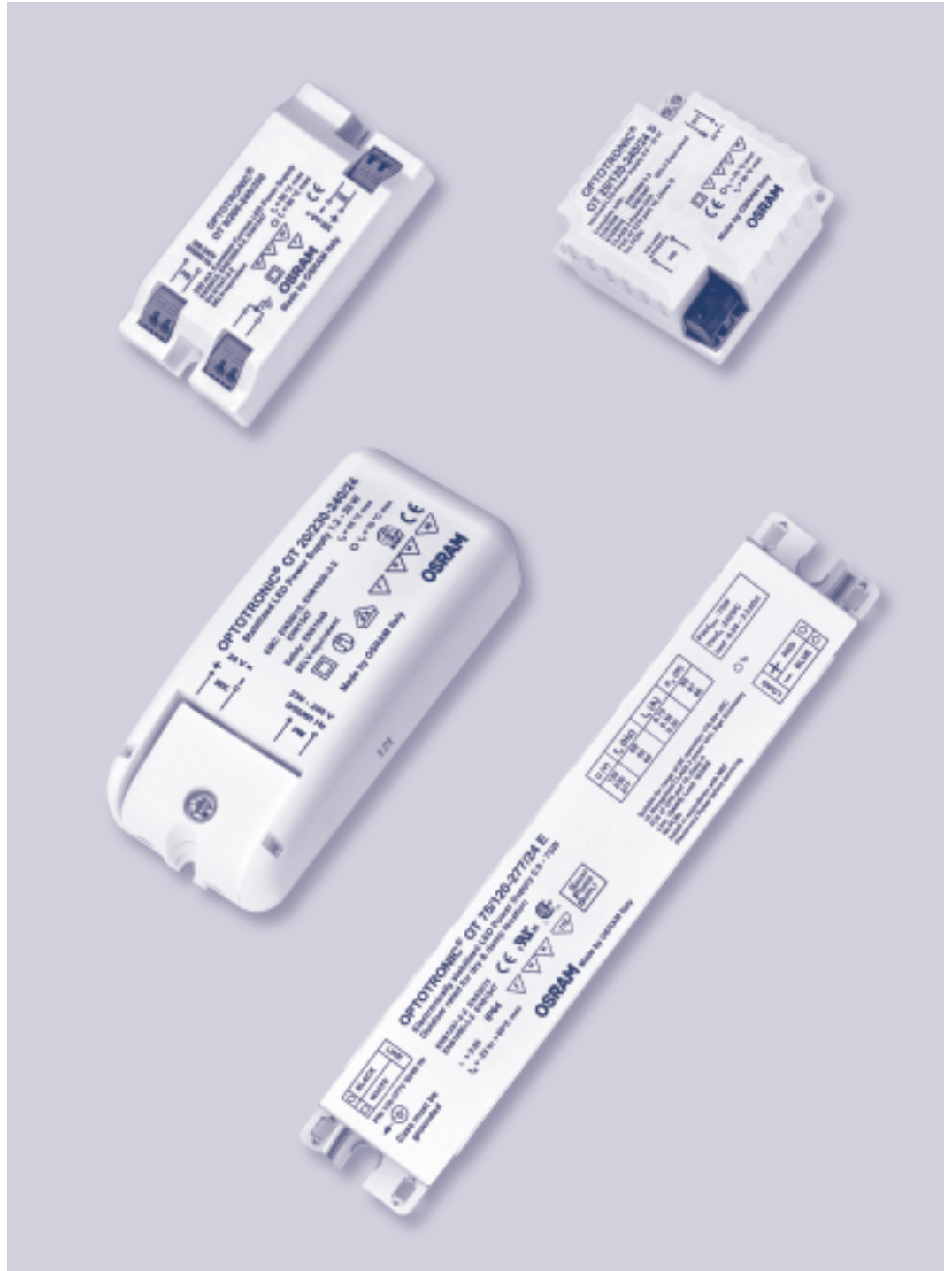

Product Overview  
Installation Instruction  
Working Condition

SEE THE WORLD IN A NEW LIGHT



# Contents

<b>1. Introduction</b>	3
1.1 LED-Modules	3
1.2 Power Supplies	3
1.3 Type field and description	5
1.4 Product Overview	6
<b>2. Features of OSRAM Products</b>	7
2.1 LED-modules from OSRAM	7
2.1.1 Power Supplies	8
2.1.2 LED-modules with optics	10
2.2 OPTOTRONIC®-Power Supply	11
2.2.1 Advantages	12
2.2.2 Products	13
2.2.3 Technical tips	14
2.2.4 Function and design	18
2.2.5 Safety – short circuit, overload/overheating protection, galvanic insulation	19
2.2.6 Electromagnetic compatibility	20
2.2.7 Noise emission	21
2.2.8 Parallel/ series connection	22
2.2.9 Starting current/ automatic circuit breakers	23
2.2.10 Thermal management	23
2.2.11 Outdoor application	24
2.3 List of combinations for LED-modules with OPTOTRONIC®-power supplies	24
2.4 Considerations regarding wattage	26
2.5 Control units for LED-modules	26
2.5.1 Control units for constant voltage LED-modules	27
2.5.2 Constant current control units	29
<b>3. Dimming and Colour-mix with LED-modules</b>	31
3.1 Dimming of LED-modules	31
3.1.1 Dimensioning control units	32
3.1.2 Examples for system wiring	33
3.2 Colour-mix with LED-modules	35
3.2.1 Applications with static colours	35
3.2.2 Applications with dynamic colour changes	38
3.3 Planning and dimensioning of RGB systems	43
3.3.1 LED-modules	46
3.3.2 Control unit	47
3.3.3 Power supply	48
3.3.4 Example how to calculate the wattage of a RGB-system	48
<b>4. Light Management Systems</b>	51
4.1 1...10 V interface	51
4.1.1 Installation instructions	52
4.1.2 Control units	53
4.1.3 Analogue output	57

4.2	DALI interface . . . . .	58
4.2.1	Features . . . . .	59
4.2.2	DALI: OSRAM's lighting controls . . . . .	61
4.2.3	DALI EASY . . . . .	61
4.2.4	Connection with DALI CON . . . . .	62
4.3	DMX interface or building management systems . . . . .	63
<b>5.</b>	<b>Installation Instructions . . . . .</b>	<b>64</b>
5.1	Maximum lengths of low voltage cables . . . . .	64
5.1.1	Maximum lengths of low voltage cables due to radio interference . . . . .	64
5.1.2	Maximum lengths of low voltage cables due to voltage drops . . . . .	65
5.1.3	Wiring of LED systems as bus systems . . . . .	69
5.2	Recommended cables . . . . .	70
5.3	Cable routing . . . . .	71
<b>6.</b>	<b>Examples of applications . . . . .</b>	<b>72</b>
6.1	Architectural Lighting . . . . .	72
6.2	Illuminated signs . . . . .	72
6.3	Orientation and safety lighting . . . . .	72
6.4	Shop lighting . . . . .	73
6.5	Mood and effect lighting . . . . .	73
<b>7.</b>	<b>Appendix . . . . .</b>	<b>74</b>
7.1	Description of type field . . . . .	74
7.2	Abbreviations . . . . .	75
7.3	IP types of protection for luminaires . . . . .	76
7.4	Data sheets . . . . .	77
7.4.1	10 V constant voltage OPTOTRONIC® power supplies . . . . .	77
7.4.2	24 V constant voltage OPTOTRONIC® power supplies . . . . .	78
7.4.3	Constant current OPTOTRONIC® power supplies . . . . .	79
7.4.4	OPTOTRONIC® control units . . . . .	80
7.5	Index . . . . .	82

# 1. Introduction

## 1.1 LED-Modules

OSRAM therefore offers a broad range of products from single LED (Light Emitting Diode) to complete modules. More and more LED are being used in general lighting applications as alternative for conventional light sources. LED are a few millimetres in size and based on a semiconductor technology converting electric current into light.

Basic principle of LED

A LED consists of several layers of semi-conducting material. When a LED is operated with DC voltage light is generated in the so-called active layer. The generated light is emitted directly or by means of reflection.

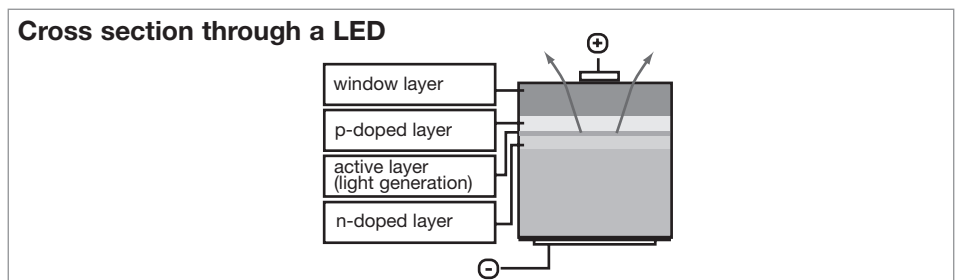

In contrast to lamps emitting a continuous spectrum, LED emit light of a certain colour. The colours depend on the used semiconductor materials. Two combinations of material are being used (AlInGaP and InGaN) to generate high brightness LED with all colours, from blue to red. White light is generated by luminescence conversion, which means that blue light from the diode is exciting a yellow phosphor and both parts together add up to white light. For each colour a different voltage is necessary to operate the diode in conducting direction.

OSRAM LED-modules

OSRAM LED-modules consist of a certain number of single LED mounted on boards with integrated active or passive current control. In addition, optical components are offered for the different families of modules. The boards can be rigid or flexible thus allowing for a three dimensional installation.

## 1.2 Power Supplies

The LED modules are not equipped with any electrical protection on the board itself. Therefore, the entire intelligence and the necessary protection features have to be integrated into a power supply.

This has been realized in OSRAM's OPTOTRONIC® family. Only the combination of OSRAM's LED – modules and OPTOTRONIC® power supplies guarantees the best operation and highest system safety.

The OPTOTRONIC® product family is divided in the following sub-groups:

- Power supplies
- Control units
- Power supplies with integrated control units

Power supplies OPTOTRONIC® products are open circuit and short-circuit proof. They are protected against overload and too high temperatures. They are developed according to all European standards. In addition, all products are operated according to protected low voltage (SELV).

The OPTOTRONIC® product range carries two kind of power supplies which are differentiated by their principle of operation:

- LED power supplies operated with constant voltage 10 V or 24 V have an electronically controlled voltage supply for LED-modules with a maximum power from 6 W to 75 W.  
Products are available in output voltages of 10 V<sub>DC</sub> and 24 V<sub>DC</sub> to operate LED-modules.
- LED power supplies for constant current of 350 mA and 700 mA have an electronically controlled current supply for LED-modules with a maximum power of 9 W to 35 W.  
The output current to operate LED-modules is 350 mA or 700 mA

At this point in time, OPTOTRONIC® power supplies with 10 different housings are available.

Control units Control units are either electronic dimmers for general use or sequencers which are used for colour changing application or so-called running lights.

*Attention:*

*OPTOTRONIC® control units cannot be dimmed by leading edge or trailing edge dimmers.*

At the moment, the following compact control units with strain relief are available:

- OT DIM
- OT RGB 3 Channel DIM
- OT RGB Sequencer
- OT DALI DIM



Power supplies with integrated control units OSRAM offers an OPTOTRONIC® version combining power supply, DALI-interface and dimmer in one unit.

Compact housing dimensions with a maximum power of 25 W and an output voltage of 24 V  
OT DALI 25/220-240/24RGB



*Attention:*

*All power supplies and control units can be used in any combination The only exception are constant-current power supplies which cannot be combined with constant voltage control units.*

### 1.3 Type field and description

The units described above differ in wattage and output voltage respectively output current:

Wattages of 6, 8, 9, 10, 12, 18, 20, 35, 50 and 75 W are available. The wattage is part of the product description and can be found right after OT.

The different output voltages (10 V or 24 V) are also part of the product description. The last two numbers describe the output voltage of the power supplies and control units respectively the input voltage of the LED-modules.

An exception are constant current power supplies/control units. In this case the last three numbers stand for the output current (350 mA or 700 mA).

The product description contains information regarding important electrical data of a control gear, for example OT 50/120-277/10E:

























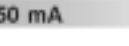

OT	OPTOTRONIC®
50	maximum power in W
120-277	permissible mains voltage in $V_{AC}$
10	for constant voltage products: output voltage for LED-modules in $V_{DC}$ , for constant current products: output current for LED-Modules in mA
E	additional information, here: suitable for outdoor application (exterior)

(Further important marks and features are described § 1.1, page 3.)

## 1.4 Product Overview

The following overview contains power supplies and control units of the OPTOTRONIC® product range and LED-modules:

### OPTOTRONIC® product range and LED-modules

Power supplies		Controllers		LED-modules	
<b>10 V</b>	 OT 6/220-240/10CE  OT 10/220-240/10L  OT 50/220-240/10  OT 50/120-277/10E	<b>1... 10 V</b>	 OT DIM  OT RGB 3 Channel DIM  OT RGB Sequencer	<b>10 V</b>	 LINEARlight  BACKlight  LINEARlight Flex (Side LED)
<b>24 V</b>	 OT 6/100-240/24CE  OT 8/200-240/24  OT 20/230-240/24  OT 20/120-240/24S  OT 75/220-240/24  OT 75/120-277/24E			<b>24 V</b>	 LINEARLight Colormix  LINEARLight Colormix Flex  LINEARLight Flex (Top LED)  COINLight  EFFECTLight
<b>24 V</b>			 OT DALI 25/220-240/24 RGB		
<b>350 mA</b>			 OT 9/200-240/350  OT 9/10-24/350 DIM	<b>350 mA</b>	 DRAGONpuck  DRAGONTape

## 2. Features of OSRAM Products

The following pages contain all important information regarding OSRAM's LED products. From LED to Electronic Control Gear, you will get to know the products, their advantages and technical data. The main focus of this paragraph is to guide you through the variety of products by giving you important information to solve your problems.

### 2.1 LED-modules from OSRAM

As one of the world's leading manufacturers of light emitting diodes OSRAM offers a wide variety of LED products, from single LED to LED-modules. LED-modules contain various LED connected on a circuit board.

We differentiate between LED-modules with and without optics. Besides rigid modules we offer also flexible modules. All flexible modules are described by the suffix „Flex“. In the figure below you will find an overview of OSRAM LED-modules.

#### OSRAM LED-Modules

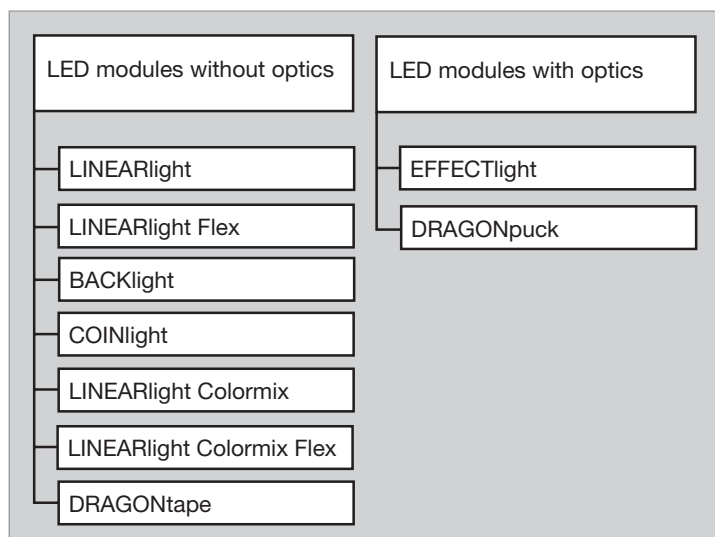

Currently, LED-modules are offered in the following colours:

- A-ambe (red)
- T-true green or V-verde
- Y-yellow
- B-blue
- W-white
- O-orange (only for some modules)



## 2.1.1 LED-Modules without Optics

LINEARlight Piece for piece flexible light.

LINEARlight is a LED-module on a solid board. As LINEARlight modules can be divided as well as linked together they can be adjusted to any desired length in the most flexible way.

LINEARlight can be used in many applications such as edge lighting of transparent or semi-transparent material, in emergency lighting, for signage, for contour lighting or to accentuate walkways.



LINEARlight Flex A new role for innovative lighting.

LINEARlight Flex is a LED-module mounted on a flexible board. Like LINEARlight it can be used in many applications such as edge lighting, emergency lighting, for signage, to accentuate walkways or for precision backlighting of complex contours.

LINEARlight Flex modules are also available as LINEARlight Colormix Flex.



LINEARlight Colormix  
LINEARlight Colormix Flex

LINEARlight Colormix is a linear LED-module for colour-dynamic applications (RGB). Every module contains 30 LED, each chip with the three colours red, green and blue.



LINEARlight Colormix can be used in many applications such as edge lighting of transparent and semitransparent material. LINEARlight Colormix is also available as Flex-version on a flexible board and with two directions of light emission: to the top (Top LED) and to the side (Side LED).

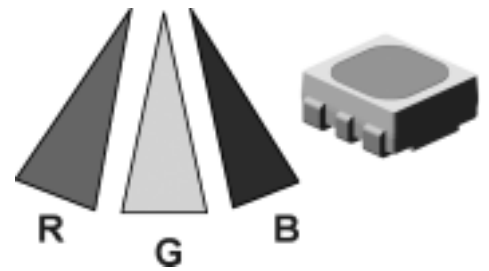

BACKlight BACKlight can be individually formed.

BACKlight-modules consist of single boards which are connected with flexible wires, each board containing four LED. They are especially suitable for backlighting of semitransparent material in signage applications but also in many general lighting applications.



COINlight Round solutions for compact fixtures

COINlight are compact and round LED-modules with LED mounted on a solid board in a circle. COINlight can be used as light source for orientation lighting or in sconces and floor lights.

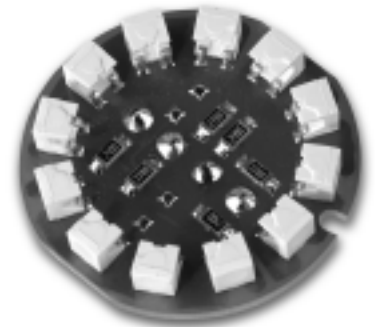

DRAGONtape® OSRAM's High-Flux LED Golden DRAGON® is the newest generation of LED-Systems.

DRAGONtape® is the ideal solution for the development of luminaries with LED. With its flexible LED-structure DRAGONtape® is suitable for backlighting and orientation lights.

Main applications in general lighting are shop lighting, furniture, effect lighting and industrial applications.

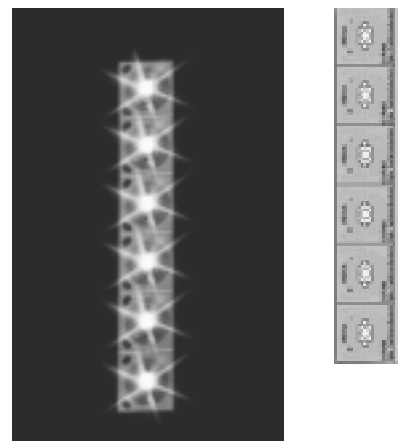

## 2.1.2 LED-modules with optics

DRAGONpuck® DRAGONpuck® are long-lasting light sources suitable in particular for reading lights with high safety standards. They can be used in spotlights for entertainment applications such as discotheques, for accent lighting of buildings and as light source for furniture lighting.

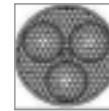
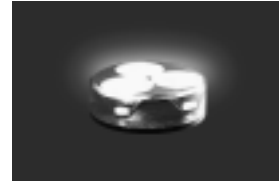

EFFECTlight Decorative effects for surfaces

EFFECTlight are suitable especially in and on buildings, lighting effects for columns and arches, rays of light on surfaces or small spotlights.



The following table contains the description and important technical data of LED-modules.

	<b>LED-module</b>	<b>Reference</b>	<b>Input voltage/ current</b>	<b>Electrical data</b>
<b>Without optics</b>	<b>LINEARlight</b>	LM01A-x <sup>1)</sup>	10 V <sub>DC</sub>	0.32 - 0.4 A 3.2 - 4 W
	<b>LINEARlight Flex</b>	LM10A-x	24 V <sub>DC</sub>	0.04 - 0.05 A 0.96 - 1.2 W <sup>2)</sup>
	<b>LINEARlight Flex</b>	LM11A-x	10 V <sub>DC</sub>	0.02 - 0.04 A 0.2 - 0.4 W <sup>3)</sup>
	<b>LINEARlight Colormix</b>	LM01M-RGB	24 V <sub>DC</sub>	0.075 - 0.15 A 1.8 - 3.6 W
	<b>LINEARlight Colormix Flex</b>	LM10M-RGB	24 V <sub>DC</sub>	0.7 - 1.4 A 17 - 34 W
	<b>BACKlight</b>	LM03A-x	10 V <sub>DC</sub>	0.32 - 0.4 A 3.2 - 4 W
	<b>COINlight</b>	CM01E-x	24 V <sub>DC</sub>	0.02 - 0.06 A 0.5 - 1.2 W
	<b>DRAGONtape®</b>	DT6-W2-x DT6-V1 DT6-B1 DT6-A1 DT6-Y1	350 mA	7,2 W  4,8W
<b>With optics</b>	<b>DRAGONpuck®</b>	DP3-W2-x DP3-V1 DP3-B1 DP3-A1 DP3-Y1	350 mA	3,6 W  2,4 W
	<b>EFFECTlight</b>	WL01A-x	24 V <sub>DC</sub>	0.04 - 0.05 A 1.1 - 1.3 W

All technical features are valid for the entire module. Due to the complexity of the production process the typical values given above are only of statistical nature.

<sup>1)</sup> x stands for the following colours:

A = red, O = orange, Y = yellow, T = green, B = blue, W = white

<sup>2)</sup> for the smallest unit with 10 LED

<sup>3)</sup> for the smallest unit with 4 LED

## 2.2 OPTOTRONIC®- Power Supply

The optimum operation of LED-modules requires power supplies which are made to achieve the desired product features. LED-modules from OSRAM are designed for 10 V and 24 V in order to allow a maximum of application options combined with low energy consumption. OPTOTRONIC® power supplies are developed particularly to operate LED-modules. They are designed for 10 V and 24 V and operate with a stabilised DC voltage of highest efficiency. In addition, OSRAM offers constant current power supplies to operate the DRAGON

range with a defined output current of 350 mA.

### 2.2.1 Advantages

OPTOTRONIC® power supplies offer many convincing advantages which can be summarized as follows:

- OPTOTRONIC® are power supplies for constant-voltage or constant current especially designed to operate LED-modules.
- Due to their high efficiency, OPTOTRONIC® power supplies offer minimum energy consumption.
- OPTOTRONIC® are compact power supplies suitable for installation in tight spaces.
- Some OPTOTRONIC® are also equipped with cable clamp and therefore also suitable for installation independent from lighting fixtures.
- OPTOTRONIC® can be operated with long secondary cables.
- OPTOTRONIC® operate various LED-modules. Several modules can be operated in parallel on one unit (not with constant current).
- OPTOTRONIC® have been developed for the lighting industry. Therefore, they fulfill all the well-known requirements of Electronic control gear and meet the necessary national and international standards.
- OPTOTRONIC® are SELV equivalent and protected against short-circuits and overload.

Due to the system design OPTOTRONIC® and LED-module, it is possible to use always the latest generation of LED. This enables us to take advantage of the dynamic innovation in LED-technology without having to change the system design (see figure below).

#### System design OPTOTRONIC® and LED-module

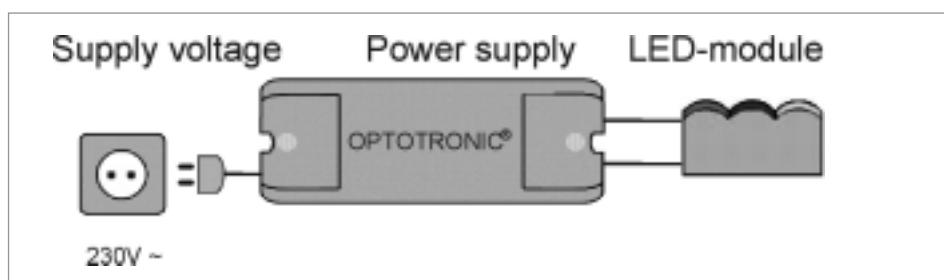

## 2.2.2 Products

Constant-voltage power supplies OPTOTRONIC® are available in output voltages of 10 V<sub>DC</sub> and 24 V<sub>DC</sub> with rated outputs from 6 W to 200 W.

For output currents of 350 mA and 700 mA with a rated power output of 9 W to 35 W. At the moment, the following units are available (for technical data please see § 7.4.1, page 77 ff.):

OPTOTRONIC®  
OT 6/100-120/10CE  
OT 6/100-120/24CE  
OT 6/220-240/10CE  
OT 6/220-240/24CE

Version for installation in flush-type boxes, connection with wires protected against dust and moisture according to IP65.



OPTOTRONIC®  
OT 8/200-240/24

Unit in a very compact housing suitable for installation in lighting fixtures. Class II.



OPTOTRONIC®  
OT 10/220-240/10 L

A very compact housing ideal in combination with LINEARlight, very good efficiency, optimised thermal behaviour. The long shape is best suitable for linear lighting fixtures.



OPTOTRONIC®  
OT 12/230-240/10  
OT 20/230-240/24

Stand-alone unit with cable clamp, wire connection with screw terminal. Class II.



OPTOTRONIC®  
OT 20/120-240/24S

Compact unit suitable for installation in lighting fixtures.



OPTOTRONIC®  
 OT 50/220-240/10  
 OT 75/220-240/24

Robust housing with cable clamp, independent LED-converter for Class II. Due to their high efficiency and optimised thermal behaviour, these units have a very long life.



OPTOTRONIC®  
 OT 50/120-277/10E  
 OT 75/120-277/24E

Units for outdoor application in IP 64, LED-converter for Class I. Due to their high efficiency and optimised thermal behaviour, these units have a very long life.



OPTOTRONIC®  
 OT 9/100-120/350E  
 OT 9/200-240/350

Unit for High Flux LED-modules with electronically stabilised constant current, application in Class II; fixtures possible due to already integrated earth-wire connection.



### 2.2.3 Technical tips

OPTOTRONIC® are available for supply voltages from 100 V to 277 V. Independent of the supply voltage, either the output voltage or the output current is controlled and constant depending on the type of OPTOTRONIC®.

Unlike conventional transformers the output voltage of OPTOTRONIC® shows no dependence on the load: OPTOTRONIC® power supplies operate LED reliably also with partial loads.

The technical data of OPTOTRONIC® power supplies are summarized in the appendix.

Permitted mains voltage For 230 V (240 V) AC-mains the nominal supply voltage is 230 V<sub>eff</sub> (240 V<sub>eff</sub>). Over-voltages up to 10% are permitted.

*Attention:*

*For higher voltages a trouble-free operation of OPTOTRONIC® cannot be guaranteed and the units may be damaged.*

All OPTOTRONIC® units are protected according to EN 61547 against short-time (transient) over-voltages known from the switch-off process of inductive loads such as fluorescent lamps operated with magnetic ballasts.

DC voltage operation Types marked with ~= or 0 Hz in the technical data can be operated with DC voltage and are suitable for emergency lighting according VDE 0108. All LED-modules have the same lumen output no matter whether they are operated with AC or DC voltage.

Life and permitted temperature range Besides specification and quality of electronic components their failure rate depends very much on the operating temperature. Rising temperatures result in a reduction of life, overheating can damage electronic components and can lead to a failure of the entire control gear. On every OPTOTRONIC® unit a measuring point has been defined for which the maximum permitted temperature  $t_c$  may not be exceeded. The maximum permitted temperature  $t_c$  is closely linked to the temperature of electronic components and therefore defining the life of the components and the entire unit. It is advisable not to exceed the maximum permitted ambient temperature  $t_a$  respectively maximum permitted temperature at the measuring point  $t_c$  as described in the table below.

Products	$t_a$	$t_c$
OT 6/100-240/10COS	50 °C	70 °C
OT 6/100-240/24COS	50 °C	70 °C
OT 8/200-240/24	45 °C	80 °C
OT 10/220-240/10 L	45 °C	70 °C
OT 12/230-240/10	50 °C	70 °C
OT 20/230-240/24	45 °C	70 °C
OT 20/120-240/24 S	50 °C	75 °C
OT 50/220-240/10	50 °C	75 °C
OT 50/120-277/10E	60 °C	90 °C
OT 75/220-240/24	50 °C	80 °C
OT 75/120-277/24E	60 °C	90 °C
OT 9/10-24/350	50 °C	80 °C
OT 9/10-24/350E	50 °C	80 °C

$t_a$ : maximum permitted ambient temperature;

$t_c$ : maximum permitted temperature at the measuring point

By not exceeding the maximum  $t_c$ -temperature a typical ECG achieves its nominal life of 30,000 hours based on the total failure rate of components and an ECG-failure rate of 10 %. This equals to a failure rate of 3.3 ‰ per 1000 hours of operation. These values are exceeded by the long-life outdoor versions OT 50/120-277/10E and OT 75/120-277/24E (50 W and 70 W) with a nominal life of 50,000 hours and a failure rate of 10 %. In other words a failure rate of 2 ‰ per 1000 hours of operation.



Because of the exponential relation between temperature and failure rate of electronic components exceeding the permitted  $t_c$ -temperature reduces the life of an ECG significantly. On the other side, ECG-life is extended significantly at temperatures below the  $t_c$ -temperature. The diagram below shows the life expectancy of ECG at various  $t_c$ -temperatures.

### Life expectancy of OPTOTRONIC® power supplies

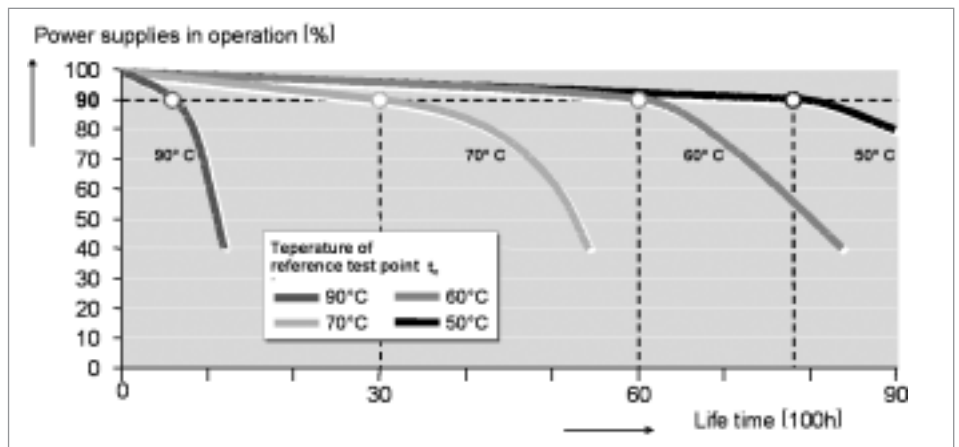

Attention:

As a rule of thumb we can expect double the lifetime for OPTOTRONIC® when the temperature at  $t_c$ -point is permanently 10 °C below the maximum permitted temperature.

OPTOTRONIC® operate reliably within the temperature range specified for the various types (see also technical data).

In general, too high temperatures have a negative effect on the electronic components. As a result, the power supply will not reach its nominal life. When installing a power supply outside a lighting fixture make sure to not install it too close to any heat source (light source) in order to avoid overheating.

Permitted power range

The power range of power OPTOTRONIC® supplies is reflected in the type description: For example, OT6 can be operated up to 6 W, OT 20 up to 20 W. For power consumption beyond 25 W **Smart Power Supply** (SPS) units, i.e. OT 5, OT 75, are used (see section OPTOTRONIC greater 25 W).

Therefore, the following sections are divided in power ranges less than 25 W and more than 25 W.

OPTOTRONIC® with less than 25 W of maximum module wattage

OPTOTRONIC® up to 25 W of maximum module wattage offer constant output voltages in the vicinity of the rated output wattage. Only if the rated wattage is significantly exceeded, the output voltage will be reduced. This dependency of output voltage from module wattage is described in the following diagrams.

### Overload behaviour of 10 V-OPTOTRONIC®

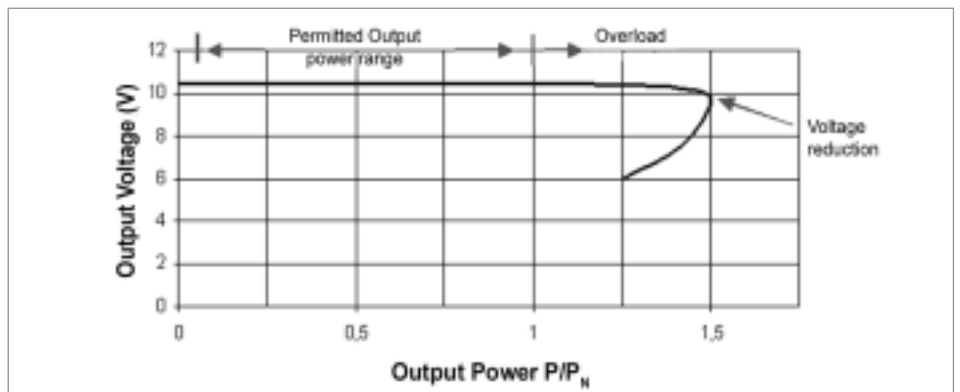

### Overload behaviour of 24 V-OPTOTRONIC®

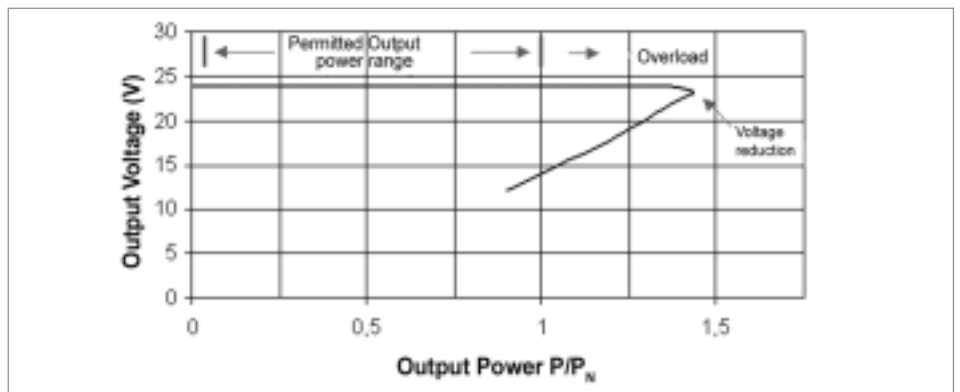

$P_N$  is the maximum power of the OPTOTRONIC® power supply,  $P$  stands for the wattage of the LED-module. The ratio  $P/P_N$  is a measure of the OPTOTRONIC® load. Exceeding the maximum load ( $P/P_N > 1$ ) bears the risk of overheating the power supplies. A short term operation is possible up to an overload of 30 %. From that point upward the OPTOTRONIC® starts controlling the power by dimming down.

*Attention:*

*Operating OPTOTRONIC® continuously above maximum load will overpower electronic components and will reduce the life of the power supply. Further overload results in a safety switch-off.*

OPTOTRONIC® with more than 25 W of maximum module wattage

Depending on the ambient temperature LED-modules vary in power consumption. For example, at very low temperatures (below 0 °C) the required power is significantly higher than under standard conditions. This may cause problems in particular when using wattages of more than 25 W. In order not to overload the power supplies OSRAM has developed **Smart Power Supply**. This feature is compensating any increased power consumption of LED-modules. This intelligent control guarantees constant light technical data for very low temperatures as well as high temperatures.



OPTOTRONIC® with Smart Power Supply (SPS) have an electronically stabilised output voltage allowing to operate LED-modules at low temperatures without effecting the life of the OPTOTRONIC® power supply.

## 2.2.4 Function and design

When describing function and design we generally have to differentiate between constant voltage and constant current types.

Constant voltage units

Generating light with constant voltage power supplies happens in three steps:

1. To operate LED-modules, the input voltage (between 100 to 277  $V_{AC}$  depending on unit) has to be transformed into a protected low voltage (10 V/24 V SELV) which is constant and safe from contact.
2. For any OSRAM LED-module the required direct current is automatically generated (for example 20 mA or 50 mA depending on the type of LED used) ensuring a correct operation of LED-modules.
3. In practice this current is adjusted on the LED-module via integrated control (I-control).

How to realise the necessary direct voltage with OSRAM OPTOTRONIC® is shown in the following block diagram.

### Block diagram of constant voltage OPTOTRONIC®

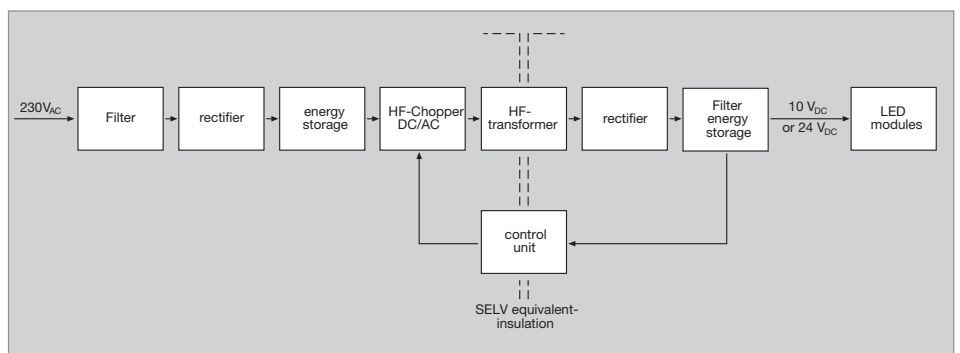

### Design of a LED-module:

When selecting the output voltage OSRAM decided to use 10 and 24 volts. These two voltages allow a variety of design options for LED-modules and reduce system losses to a minimum.

$U_A$ : supply voltage of LED-modules

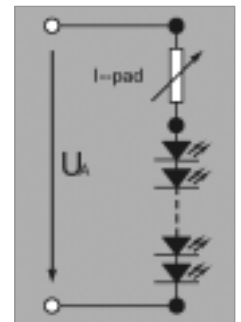

Constant current power supplies

Unlike constant voltage power supplies, constant current units keep the current electronically stable. Actual products supply a 350 mA DC current. The output voltage varies between 2 and 25 V protected low voltage (SELV).

The current control of the power supply generates the required current of 350 mA.

### Block diagram of constant current OPTOTRONIC®

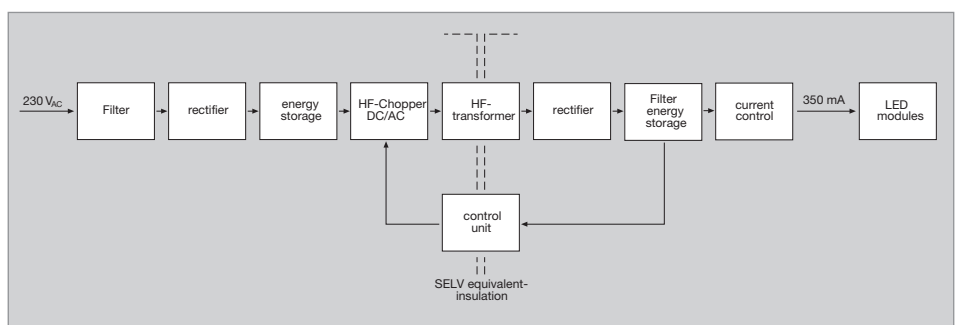

### Design of a LED-module:

Constant current LED-modules operate single LED in series. To guarantee a safe contact voltage < 25 V a maximum of 9 red or yellow or 6 white, blue or green LED can be connected in series.

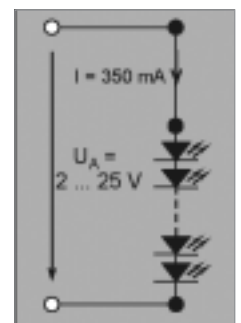

### 2.2.5 Safety – short circuit, overload/overheating protection-, galvanic insulation

#### Short circuit

OPTOTRONIC® protect themselves against the effects of a short-circuit on the secondary side.

All the units have a reversible electronic cut-off to ensure that the units will not be destroyed in the case of a short-circuit. The units will be fully operational again once the cause of the short-circuit has been eliminated.

#### Overload/overheating protection

OPTOTRONIC® units are equipped with reversible electronic overload protection. Even if the overload persists, there will be no damage to

the unit. In this case, the output power is either reduced or automatically disconnected.

Even if external heat sources cause temperature exceeding the specified maximum, they will automatically reduce their output to protect themselves. The user will notice a drop in lumen output and finally a shutdown of the power supply.

### Galvanic insulation

OPTOTRONIC® meet the requirements relating to safety transformers for safety extra-low voltage (SELV or SELV equivalent according to EN 61347-2-2 / EN61347-2-13). The dielectric strength (galvanic insulation) between primary and secondary sides is tested on each unit at a voltage of 4 kV.

## 2.2.6 Electromagnetic compatibility

**EMC** (electromagnetic compatibility) specifications define a series of different test criteria.

The most important in connection with electronic control gear are radio interference suppression (noise), harmonic content (up to the 39th harmonic) and immunity to interference.

	IEC, international	European standard
Radio interference suppression*	CISPR 15	EN 55015
Harmonic content	IEC 61000-3-2	EN 61000-3-2
immunity to interference	IEC 61547	EN 61547

\*for frequencies up to 30 MHz, related to wiring only



The CE and VDE EMV symbols on OSRAM units indicate compliance with immunity to interference, harmonic content and radio interference suppression requirements.

Since immunity to interference and harmonic content (but not the radio interference suppression) are determined solely by the power supply, these measurements have not to be made on luminaires with OSRAM OPTOTRONIC®-units, which all carry the VDE EMC approval mark (cost savings for the luminaire manufacturer).

### Harmonic content of the mains current

Lighting equipment is subject to restrictions on harmonics.

The maximum permissible threshold values are defined according to class C of the standard EN 61000-3-2 for the subclasses below 25 W and over 25 W. All OPTOTRONIC® power supplies are made according to this standard.

### Radio interference

The following applies to power supplies and control units (separate converters, with strain relief):

The units comply with the limit values for radio interference voltage in accordance with EN 55015 IEC. The maximum length of low voltage cables must not exceed the values given in the data sheets to comply with radio interference requirements.

For installation in lighting fixtures the following applies to all types:  
A high-quality internal filter is added to ensure compliance with the radio interference values specified in EN 55015.

When installing OPTOTRONIC® in a luminaire of protection class II, no additional measures against radio interference are required.

When installing OPTOTRONIC® units in metal case luminaires of protection class I, radio interference will increase due to the higher earth capacities. Therefore, it may be necessary to include an additional mains filter with earth connection. In any case, luminaire manufacturers are responsible to measure the radio interference behaviour of the complete lighting fixture as the level of radio interference will vary depending on the installation of the power supply. Especially primary and secondary cables have a significant effect.

### **Immunity**

The OPTOTRONIC® units comply with the immunity requirements described in EN 61547 (IEC 61547, VDE 0875 T15-2). This means they are protected against interference from external high-frequency fields, discharge of static electricity and transient overvoltages of the mains supply as defined in EN 61547.

### **2.2.7 Noise emission**

OPTOTRONIC® units are almost silent in operation. They are so quiet that even in very quiet environments they are practically not noticeable.

Therefore, they are particularly suitable for sound-sensitive areas such as radio and recording studios. The limit of the frequency-dependent sound pressure curve is based on the audibility threshold, i.e. a person with normal hearing will virtually not be able to notice the noise generated by a unit in the same room.

Factors affecting the sound pressure level are the sound power level of the unit, the absorption properties of the room characterised by its volume and reverberation time, and the number of units.

In mains supplies with a high level of distortion where the mains voltage deviates significantly from a sine wave, a „chirping“ may be heard from the reactance coils in the unit's input section.

Even under worst conditions such as installation on a wooden board, OPTOTRONIC® power supplies emit a sound power level LWA of less than 10 dB (A). This corresponds to a sound pressure level of 17 dB (A) in a typical living room.

In comparison to that acceptable sound pressure levels are:

- for a quiet living room: 35 dB (A)
- for an office: 35 dB (A)

## 2.2.8 Parallel/series connection

OPTOTRONIC® can be connected in parallel on the primary side. However, unlike conventional transformers, OPTOTRONIC® cannot be connected in parallel on the secondary side as they would be overloaded by an unequal load distribution. Also series connection is not permitted.

### Parallel connection of OPTOTRONIC®

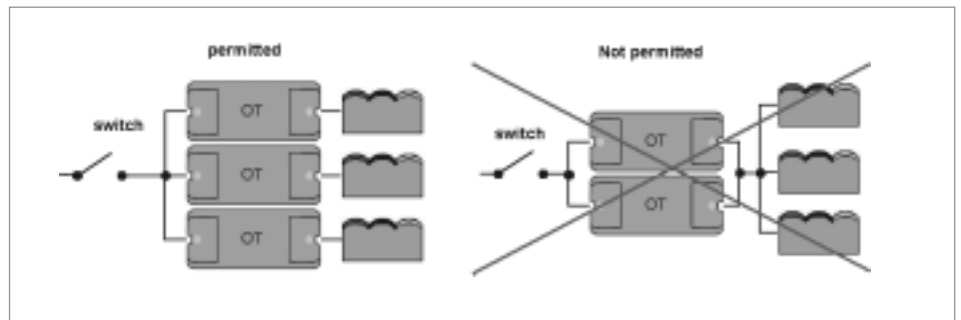

Exceptions are OPTOTRONIC® OT 50/120-277/10E and OT 75/120-277/24E. They can be connected in parallel in limited quantities due to a special control of the output power.

### Parallel connection on the secondary side of OT 50E and OT 75E

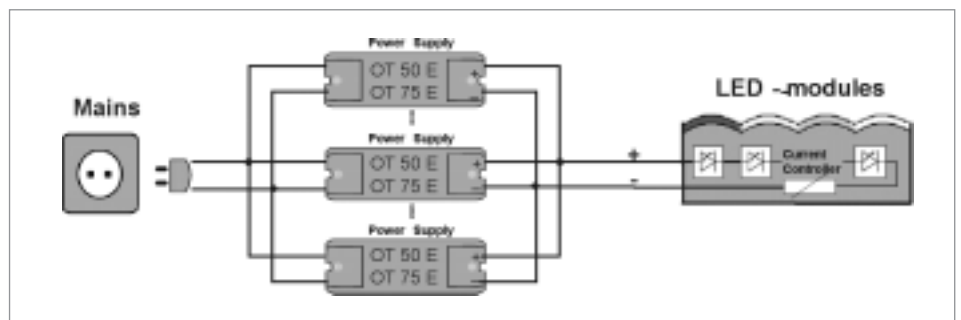

*Attention:*

*Up to five OT 50E or four OT 75E can be connected in parallel on the secondary side.*

*A parallel connection is only possible at the end of ready-to-use cables!*

*Attention:*

*Parallel connection on the secondary side is marked on the unit with the following symbol:*

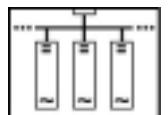

### 2.2.9 Starting current/ automatic circuit breakers

When switching on an ECG a starting current pulse  $I_p$  of very short duration ( $T_H < 1$  ms) is generated as the storage capacitor responsible for internal power supply is charged. If a large number of units are switched on simultaneously (particularly if they are switched on at peak rated voltage) a starting current will flow limiting the maximum permissible number of OPTOTRONIC® per automatic circuit breaker. Therefore, all switching equipment and protection devices have to be selected according to their current carrying capacity.

#### Maximum permissible number of OPTOTRONIC® per automatic circuit breaker:

			Maximum number of ECG per automatic circuit breaker	
ECG	$I_p/A$	$T_H/\mu s$	10A	16A
OT 6/100-240/10	4	400	11	17
OT 6/100-240/24	4	400	11	17
OT 10/200-240/10 L	16,3	108	23	38
OT 12/230-240/10	6	95	90	135
OT 20/230-240/24	10	170	42	68
OT 20/120-240/24 S	45	150	7	11
OT 50/220-240/10	33	195	7	12
OT 75/220-240/24	35	165	7	11
OT DALI 25	–	–	66	112

When using the values given in above table please note the following:

- The load data relate to a starting point at peak rated voltage (i.e. at the most unfavourable point regarding the current).
- The specified load applies to N automatic circuit breakers (Siemens type 5 SN I-2 and 5 SX) with B characteristics.
- The specified load applies to single-pole automatic circuit breakers. When using multi-pole automatic circuit breakers (2-pole, 3-pole) the permitted number of units is reduced by 20 %.

### 2.2.10 Thermal management

Although the temperature of the power supplies is low, it has to be managed. To avoid overheating the electronic converter must not be installed close to a heat source (i.e. light source). When installing OPTOTRONIC® in a luminaire a good heat transition between the power supply and the body of the lighting fixture is required. In any case, the temperature  $t_c$  at the measuring point has to be measured in order not to exceed the maximum permitted temperature  $t_{c \max}$ .

*Attention:*

*Low unit temperatures result in a long life!*



### 2.2.11 Outdoor application

In general, OPTOTRONIC® power supplies are not suitable for outdoor application; they are classified IP20 (not protected against moisture). Exceptions are products with the extension E for „exterior“. These units are designed for outdoor application and are available in IP types of protection IP 64 and IP 65. They are VDE approved and protected against dust and are splash-proof or jet-proof (see also IP-classes for luminaries §7.3, page 76). An overview of power supplies for outdoor application is given in the following table:











Power supply	Protection class
OT 6/100-120/10CE	IP 65
OT 6/100-120/24CE	IP 65
OT 6/220-240/10CE	IP 65
OT 6/220-240/24CE	IP 65
OT 50/120-277/10E	IP 64
OT 75/120-277/24E	IP 64

### 2.3 List of combinations for LED-modules with OPTOTRONIC®-power supplies

Which LED-module can be operated with which power supply depends on the following technical criteria:

- Voltage/current: The output voltage of the power supply must correspond with the input voltage of the LED-modules. LED-modules with DRAGON may only be operated with constant current units.
- Wattage: The wattage of LED-modules must be covered by the power supply.

From the following table you can see all possible combinations between OPTOTRONIC® power supplies and LED-modules.

Combinations of LED-modules / power supplies		Constant voltage power supplies		Constant current power supplies
		output voltage 10 V	output voltage 24 V	output current 350 mA
<b>Power supplies</b>		OT 6/100-120/10CE OT 6/220-240/10CE OT 10/200-240/10 L OT 12/230-240/10 OT 50/220-240/10 OT 50/120-277/10E	OT 6/100-120/24CE OT 6/220-240/10CE OT 8/200-240/24 OT 20/230-240/24 OT 20/120-240/24 S OT 75/220-240/24 OT 75/120-277/24E	OT 9/100-120/350E OT 9/200-240/350E OT 9/100-240/350 DIM
<b>LED-modules</b>				
	LINEARlight			
	LINEARlight Flex	 (Side LED)	 (Top LED)	
	LINEARlight Colormix			
	LINEARlight Colormix Flex			
	BACKlight			
	COINlight			
	DRAGONtape			
	DRAGONpuck			
	EFFECTlight			

## 2.4 Considerations regarding wattage

Wattage: The total wattage of modules can be calculated by their number. The more modules are connected the more power they consume, thus making high demands on the power supply. The maximum number of LED-modules which can be operated with one OPTOTRONIC® unit can be easily calculated by building the ratio between nominal wattage of the power supply and the total power consumption of the applied LED-module:

$$N_{\max} = \frac{P_{N, \text{OPTOTRONIC}}}{P_{N, \text{module-wattage}}}$$

$N_{\max}$ : maximum number of LED-modules to be operated with one power supply

$P_{N, \text{OPTOTRONIC}}$ : Nominal wattage of the power supply

$P_{N, \text{module wattage}}$ : Wattage of the applied LED-module

Combinations of OPTOTRONIC® with high-flux LED-modules (DRAGONtape and DRAGONpuck) are possible. As these units have a maximum output voltage of 25 V, the number of LED depends on the voltage drop at the LED and with it on their colour. The following number of LED can be operated in series with constant current OPTOTRONIC®:

Colour	Maximum number of LED	
	DRAGONtape	DRAGONpuck
Blue, green	1	2
Yellow, red	1,5	3
white	1	2

## 2.5 Control units for LED-modules

The control units complete OSRAM's LED-systems. In addition to LED-modules and OPTOTRONIC® power supplies, dimmable units OT DIM and colour control units are available.

A system from one source consisting of power supply, control unit and light source not only offers advantages to the user but also opens new areas for LED in general lighting applications.

Control units are used on the secondary side of the power supplies which means they are installed between power supply/secondary voltage and LED-modules.

### System with OPTOTRONIC® power supply, controller and LED-module

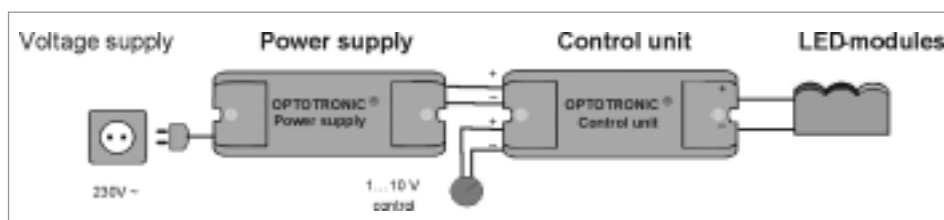

There are control units suitable for 10 V and 24 V LED-modules as well as 350 mA LED-modules. OSRAM offers both constant voltage and constant current controls:

	Description of control unit
Control units for constant voltage LED-modules	OT DIM OT RGB Sequencer OT RGB 3-Channel DIM OT DALI 25/220-240/24 RGB
Control units for constant current LED-modules	OT 9/10-24/350 DIM

### 2.5.1 Control units for constant voltage LED-modules

**OT DIM** OT DIM is a 1...10 V control unit allowing individual dimming of LED-modules via pulse width modulation (PWM). With PWM the desired light output can be individually generated by interrupting the supply of LED-modules with a frequency of 135 Hz. This high frequency guarantees flicker-free lighting comfort. PWM technology allows to realise an exactly linear dimming characteristics with the highest dimming speed.

Product features at a glance:

- Technology: pulse width modulation (PWM) with a frequency of 135 Hz
- Max. operating current 5 A, i.e. max. wattage 50 W for 10 V LED-modules and 120 W for 24 V LED-modules
- Reversible electronic protection against overload, overheating and short circuit
- Dimming range from 0 to 100%
- Slim and flat housing with cable clamp for stand-alone installation.



Via 1...10 V-interface standard dimmers as well as potentiometers or digital signals can be used for dimming purposes.

#### **OPTOTRONIC® control units open up the world of coloured lighting:**

The new control components OT RGB 3-Channel DIM and OT RGB Sequencer for individual LED colour control complete the OSRAM system and open up the field of RGB-technology.

OT RGB Sequencer OT RGB Sequencer is a 3-channel PWM sequencer for dynamic colour change of RGB LED-modules via pulse width modulation. The specific PWM per channel is generated by a characteristic curve pre-set by OSRAM and modulated on top of the DC input voltage 10–24 V. A 1...10 V input allows to control the colour sequence and even to set a fixed colour if required.

Product features at a glance:

- 3-channel sequencer for dynamic colour changes on RGB LED-modules with controllable speed.
- The speed of the colour sequence is controlled via 1...10 V control input.
- The maximum current is limited to 2 A per channel/colour, i.e. maximum wattage 3x20 W for 10 V LED-modules and 3x48 W for 24 V LED-modules.



OT RGB 3-Channel DIM OT RGB 3-Channel DIM is a 3-channel 1...10 V control unit allowing the individual colour control of LED-modules via pulse width modulation. The PWM is modulated on top of the DC input voltage with a frequency of 350 Hz. Each unit has three independent control circuits whose control inputs provide the necessary control voltage which makes the units suitable for operation with either passive potentiometers (100 K lin.), standard control units or complex light management systems (for example DMX interface).

Product features at a glance:

- 3-channel 1...10 V-controller for dimming and regulating colours on RGB LED-modules
- Three independent 1...10 V dimming circuits for individual colour control
- Output terminals with common + pole and max. 2 A per channel (3x20 W for 10 V LED-modules and 3x48 W for 24 V LED-modules)



OT DALI 25/220-240/24 RGB With our new OT DALI 25/220-240/24 RGB it is possible to integrate LED modules into lighting control systems. OT DALI 25/220-240/24 RGB combines mains voltage converter, DALI interface and PWM controller in one unit. The product has a DALI input for three addressable output channels for colour mixing with LED-modules thus offering the same DALI functionality as three individual ECG.

The integrated sequencer allows a stand-alone operation, particular colours can be stored as scenes. The unit contains three addressable output channels with preset short addresses:

red: short address 0

green: short address 1

blue: short address 2

and three 24 V PWM output signals.

In broadcast mode (no addresses applied) the unit operates as 1-channel dimmable ECG with a maximum wattage of 25 W. With programmed addresses it operates as 3-channel ECG (same functions as three individual ECG) with a total wattage of 25 W. When OT DALI 25/220-240/24 RGB is used as stand-alone unit to operate LED-modules, the result will be a preset sequence with specified colours. This sequence can be individually programmed in combination with a DALI controller such as DALI-EASY. After having finished the programming and disconnected the DALI controller the new sequence will be able to run.

Product features at a glance:

- Mains voltage converter, DALI interface and PWM controller in one unit
- One DALI input for three addressable output channels
- The same DALI functions as three individual ECG
- Stand-alone operation possible
- Particular colours can be stored as scenes
- Three addressable output channels with preset short form addresses for RGB applications



## 2.5.2 Constant current control units

OT 9/10-24/350 DIM

OT 9/10-24/350 DIM is designed to operate high-flux LED-modules such as DRAGONtape and DRAGONpuck providing a constant DC output current of 350 mA which is electronically stabilised. Depending on the application voltages reach values between 2 and 25 V for output wattages from 0.6 to 9 W. OT 9/10-24/350 DIM is particularly suitable to dim DRAGON products via pulse width modulation. It is equipped with a reversible electronic protection against overload, overheating and short circuit.

Product features at a glance:

- Dimmable DC/DC power supply for high-flux LED-modules
- Nominal input voltage 10-24 V<sub>DC</sub>  
max. input voltage range: 9-32 V<sub>DC</sub>
- Electronically stabilised constant current of 350 mA
- Output voltage: 2...25 V  
(safety limit for contacts)
- Output wattage: 0,6...9 W  
(up to 6 white DRAGON LED)
- 1...10 V interface for optimum dimming via PWM
- Reversible electronic protection against overload, overheating and short circuit



For technical data please see attached data sheets.

### 3. Dimming and Color-mix with LED-modules

The control units and power supplies described above allow the realisation of simple installations from dimming of single-colour LED-modules to more complex applications such as colour mixing with LED-modules or creating dynamic colour sequences. In the following paragraphs we will highlight possible applications or installations and important parameters to be considered during the planning and realisation phase.

**3.1 Dimming of LED-modules** Dimming means changing the luminous flux of a light source – or with other words: to operate a light source brighter or darker. Today, dimmable lighting installations play an increasingly important role in all application fields. The reason for that can be found in the desire to adjust the lighting level to individual needs thus increasing the comfort.

The dimming feature of lighting installations is an important component of lighting systems optimised for energy efficiency. It has to be considered that the energy consumption of a lighting installation is not directly proportional to the light output.

LED are dimmed via pulse width modulation. Dimmable lighting installations require control units which translate a input control signal into a corresponding lumen output. The following examples of OT DIM and OT 9/10-24/350 DIM demonstrate how to realise lay out and system wiring.

Luminous flux The  $\Phi$ - $U_c$ -characteristic curve shows how the luminous flux depends on the control voltage of an OT DIM. From the diagram can be seen that the luminous flux is reduced to 0 % without applied control voltage.

#### Luminous flux depending on the control voltage for OT DIM

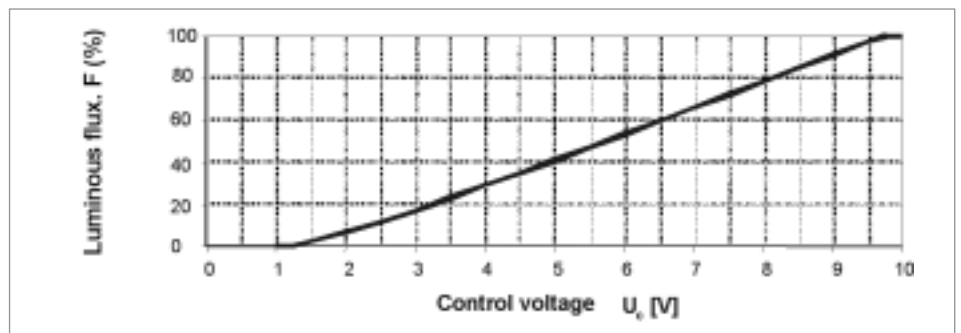



### 3.1.1 Dimensioning control units

The control units are developed to be operated with OPTOTRONIC® power supplies. Although these controllers have minimum losses they have to be taken into consideration when dimensioning power supplies. Due to the applied secondary voltage different loads have to be considered when calculating the nominal wattage of the power supply.

The total wattage of the power supply  $P_{\text{power supply}}$  is the sum of wattage of the LED-modules  $P_{\text{LED}}$  and the losses of the controller  $P_{\text{controller}}$ :

$$P_{\text{power supply}} = P_{\text{LED}} + P_{\text{controller}}$$

Dimensioning for OT DIM

The diagram below shows the maximum wattage of an OT DIM which has to be considered when laying out the dimension of the power supply.

#### Power consumption OT DIM

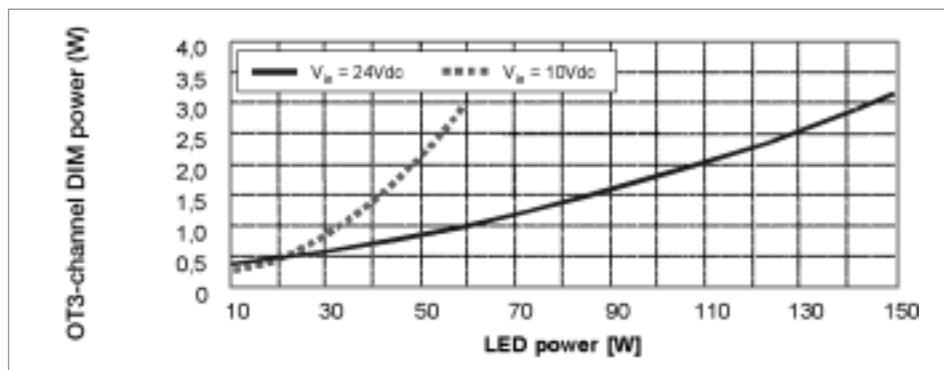

*Example:*

At full load of OT 20/230-240/24 (equivalent to a power of 20 W) an OT DIM accounts for a wattage of 0.5 W (solid line in the diagram, value at 20 W of LED power) which means that 19 W are left for the connection of LED-modules.

In addition, a voltage drop of 0.3 V has to be considered at operation with maximum current (5A).

Dimensioning for OT 9/10-24/350 DIM

The diagram below shows the maximum wattage of an OT 9/10-24/350 DIM which has to be considered when laying out the dimension of the power supply.

### Power consumption of OT 9/10-24/350 DIM

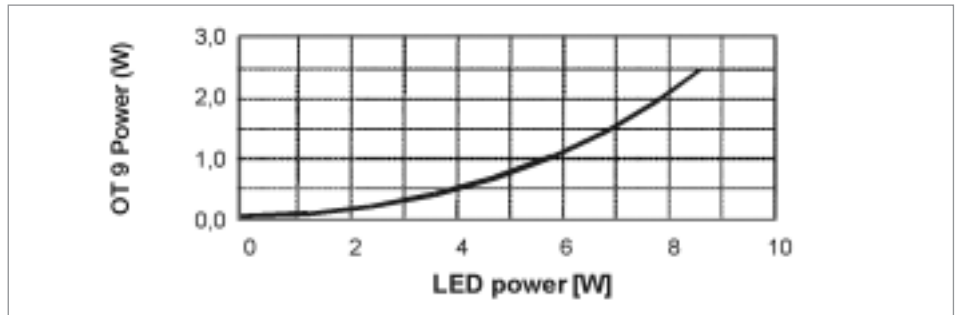

*Example:*

At full load (LED-power equals to 8,5 W) the OT 9/10-24/350 DIM accounts for a wattage of 2.5 W. Therefore the total power consumption is 11 W.

### 3.1.2 Examples for system wiring

The following examples of possible system wirings demonstrate the application of OT 9/10-24/350 DIM and OT DIM in combination with various LED-modules and show how to integrate power supplies and control units.

Dimming with OT 9/10-24/350 DIM

LED-modules are connected with the output of OT 9/10-24/350 DIM high-flux whereas supply voltage and 1...10 V control are connected with the input (see figure below):

### System wiring OT 9/10-24/350 DIM

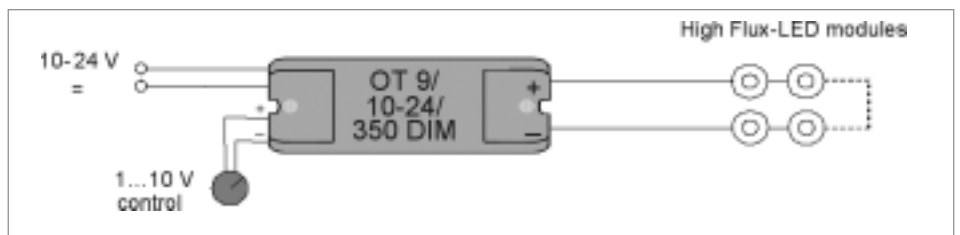

To supply voltage OPTOTRONIC® power supplies with output voltages from 10 V to 24 V can be used (see figure below):

### System wiring of OT 9/10-24/350 DIM with OPTOTRONIC® power supply

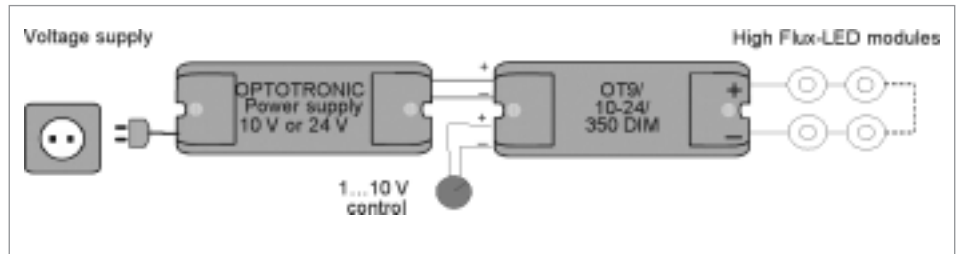

Dimming with OT DIM LED-modules are connected with the output terminals of OT DIM where voltage supply and control signal are connected to the input terminals (see figure below):

### System wiring of OT DIM with OPTOTRONIC® voltage supply

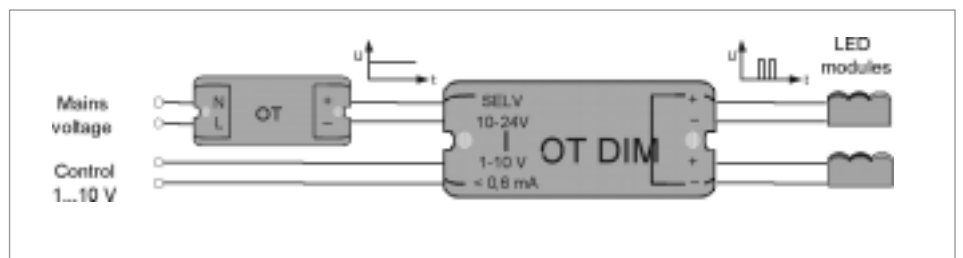

The control signal can be provided by DIM MCU which should be connected as shown in the figure below:

**System wiring of OT DIM with OPTOTRONIC® voltage supply and OSRAM DIM MCU control**

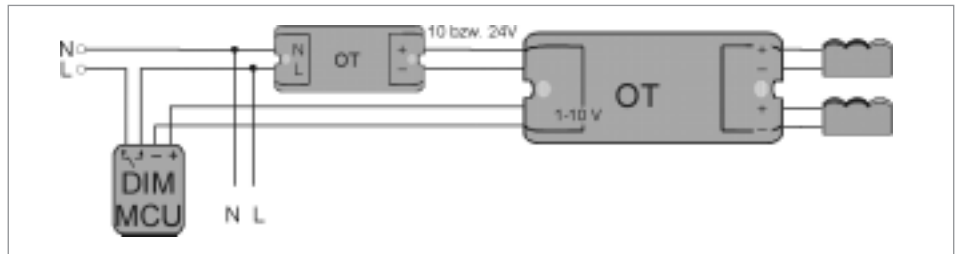

**3.2 Colour-mix with LED-modules**

LINEARlight Colormix modules allow the realisation of colour-dynamic applications. The module is made of 30 LED with 3 coloured chips each (red, green, blue). Each chip can be controlled individually thus making it possible to generate any colour in the marked triangular area of the colour table below.

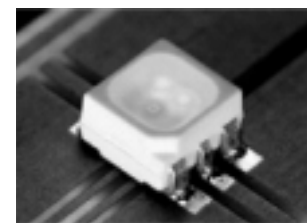
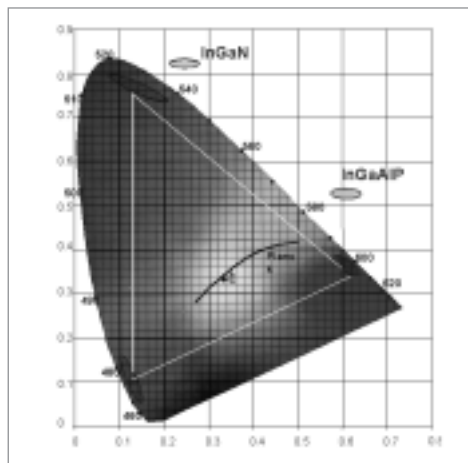

When mixing colours with LED-modules we have to differentiate between applications with static and dynamic colours. The following examples demonstrate various options to mix colours with LED-modules.

**3.2.1 Applications with static colours**

In addition to pure dimming functions, OT DIM and OT RGB 3-Channel DIM can be also used for colour controlled applications.

Examples with OT DIM

**Application of multi-colour LED-modules with a total LED-wattage of more than 75 Watt**

Different colours are realised with single-colour LED-modules in red, green and blue. The total power consumption exceeds 75 W. The LED-modules are controlled by OT DIM. As shown in the figure below each colour requires separate a power supply and controller.

**System wiring of OT DIM with OPTOTRONIC® power supply for single colours**

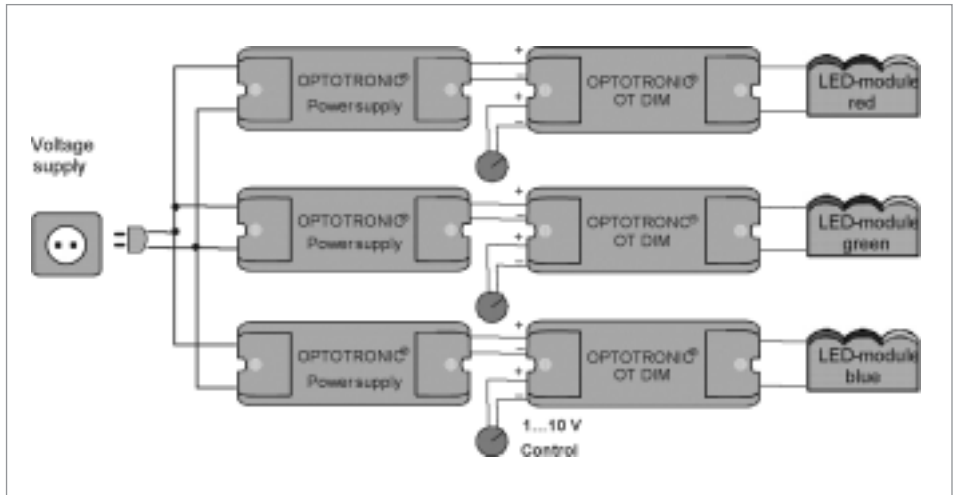

**Application of LINEARlight with a total LED-wattage between 75 and 300 Watt**

The following example is based on LED-modules in flexible or solid versions with a total power of 300 W using LINEARlight Flex or LINEARlight Colormix with an input voltage of 24 V. OT 75/220-240/24 with a wattage of 75 W and an output voltage of 24 V are chosen as power supplies. To cover the maximum wattage of 300 W four OT 75 units are needed. In the following figure you can see the system wiring and the connection of LED-modules.

**System wiring of OT DIM with OPTOTRONIC® power supply OT 75 E for LINEARlight LED-modules**

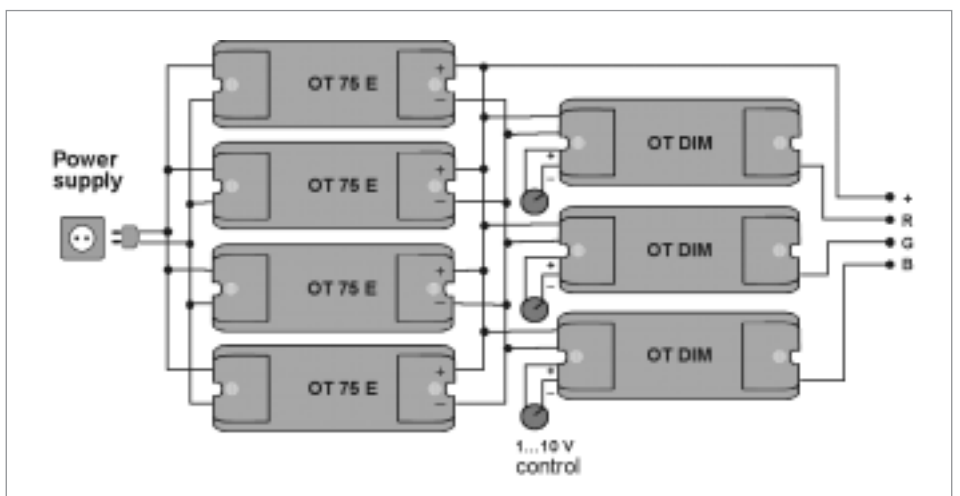

## Connection of LED-modules LINEARlight Flex Colormix or LINEARlight Colormix

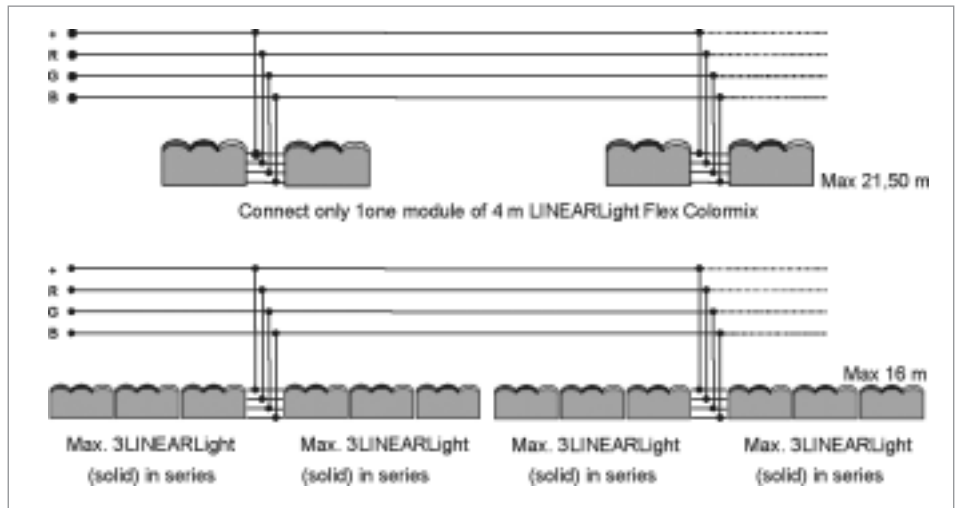

The four OPTOTRONIC® power supplies OT 75 used above provide a maximum power of 300 W (4 units with 75 W each) supplying either 21.5 m of LINEARlight Flex Colormix or 16.0 m of LINEARlight Colormix. For higher wattages than 300 W the system simply has to be multiplied.

When connecting OT DIM for RGB control please notice that the anode (+ pole) is on common terminals. In this case the control can be done via 1...10 V interface.

Of special interest is the control via analogue PC-interface and via pre-programmed control units such as sequencer (see also § 4.1.3).

Example with  
OT RGB 3-Channel DIM

### Application of LINEARlight Colormix with a total LED-wattage below 75 Watt for static colour changes

The total power of the lighting system with LINEARlight Colormix shown in the application below is less than 75 W. To control the modules potentiometers (100 kW lin.) or 1...10 V controllers can be used. In our example we use a OT RGB 3-channel DIM allowing an individual colour control through independent 1...10 V dimming circuits.

### System wiring for static colours

#### Realisation with OT RGB 3-channel-DIM

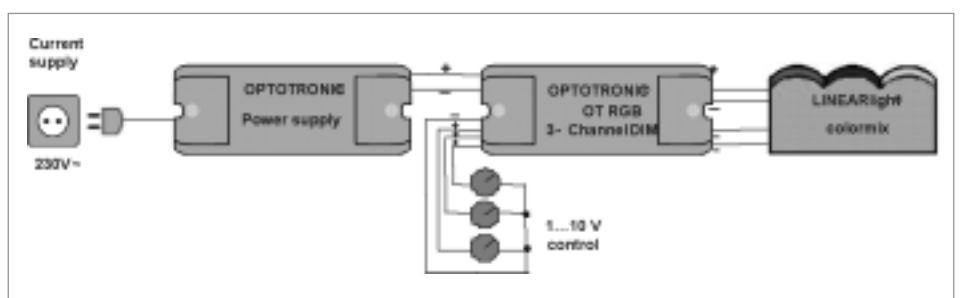

### 3.2.2 Applications with dynamic colour changes

For applications with dynamic colour changes such as changing colours in indoor lighting or dynamic lighting installation for events OT RGB Sequencer, OT DALI 25/220-240/24RGB and DALI EASY can be used.

#### Application of LINEARlight Colormix with a total LED-wattage below 75 Watt for dynamic colour changes

In an application with comparable requirements (system wattage below 75 W, LED-module LINEARlight Colormix) dynamic colour changes should be realised. An OT RGB sequencer is used as controller connected on the input side to a supply voltage of an OT power supply and to a 1...10 V control and connected on the output side to LED-modules like LINEARlight Colormix.

#### System wiring for dynamic colour changes with OT RGB Sequencer

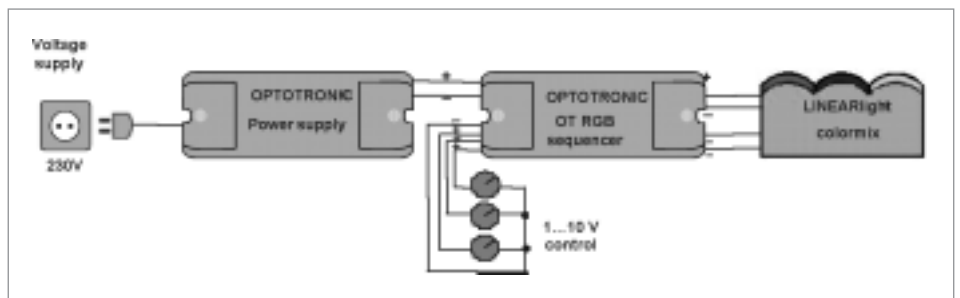

To obtain a dynamic colour change the input control voltage needs to stay within the following voltage ranges:

- < 1.2 V starting threshold
- 1.2-9.8 V speed of sequence 5 sec–10 min
- > 9.8 V holding the actual colour

For one sequence a full cycle corresponds to 6 time units where one time unit can be set between 5 seconds and 10 minutes. In accordance with the chosen set-up the lumen output will follow as shown in the figure below.

## Dynamic colour sequence of OT RGB sequencer

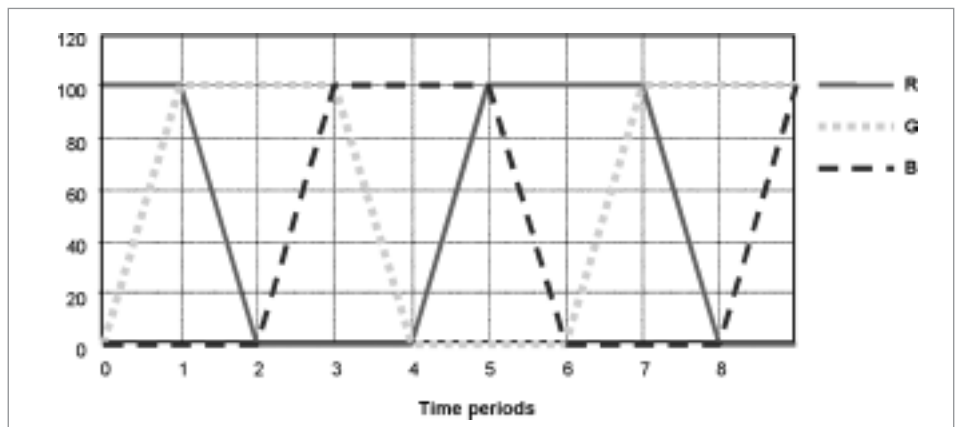

There is no linear dependence between the time period and control voltage (from threshold voltage 1.2 V to fixed colour at 9.8 V) according to the diagram below.

## RGB time periods of OT RGB sequencer

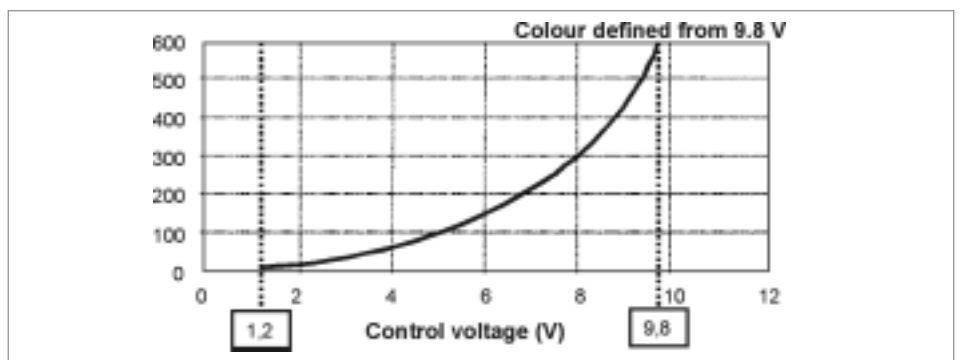

*Attention:*

*More than one sequencer **cannot** be synchronised.*

## Application of a simple running light

In the following application LED-modules LINEARlight Colormix are connected to an OT RGB sequencer. According to the figure below running lights can be realised with the sequencer by cross-wiring the LED-modules.

## System wiring of a simple running light with OT RGB sequencer

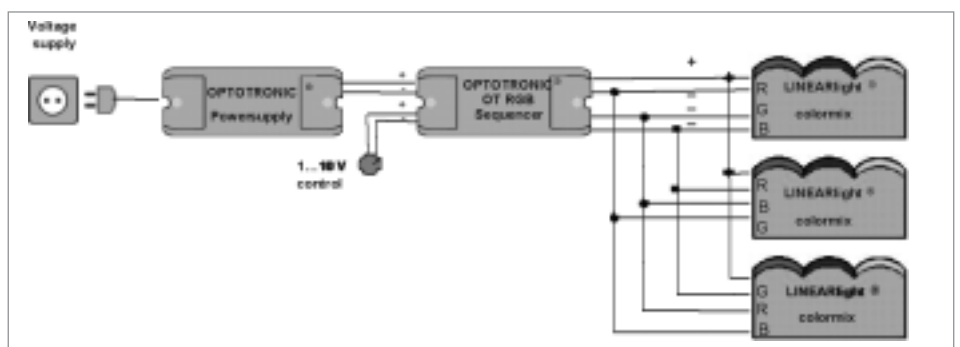



Example with OT DALI  
25/220-240/24RGB

### Realisation of colour sequences with wattages below 25 Watt

Colour sequences with wattages below 25 W can be realised with OT DALI 25/220-240/24RGB to which LED-modules can be directly connected as shown below:

### System wiring to realise colour sequences with OT DALI 25/220-240/24RGB

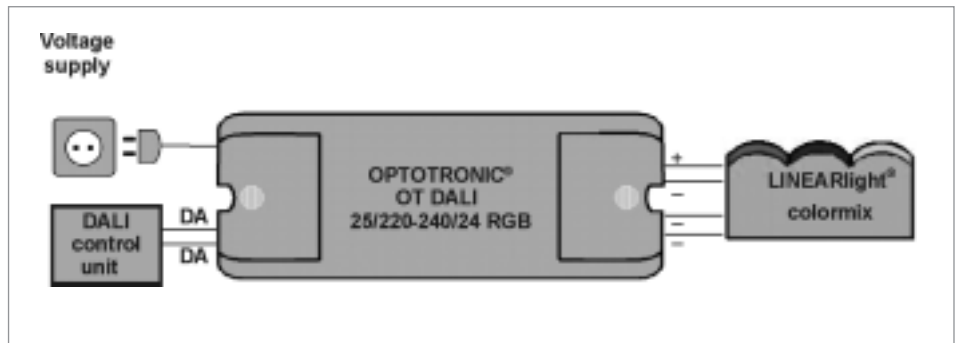

OT DALI 25/220-240/24RGB can also be used as stand-alone sequencer without DALI interface. In this case, the unit recalls all stored colour scenes with a specified speed. To use it as stand-alone sequencer it is important whether a voltage is applied to the DALI-interface terminals or not.

Activation of stand-alone sequencer:

- Sequencer status is activated if no voltage is applied to the DALI interface terminal when switching on.

Deactivation of stand-alone sequencer:

- Sequencer mode will be quit instantly if a voltage is detected at the DALI-interface terminal when switching on or during operation.

*Attention:*

*A loss of voltage during operation does not result in activation.*

### Configuration of the stand-alone sequencer

When programming a sequencer via DALI-interface transition time, duration and colour values have to be taken into consideration. Transition time is calculated as the product of fade time and fade rate:

#### Transition time = DALI Fade Time (s) \* DALI Fade Rate

DALI Fade Time (s)	0	1	2	3	4	5	6	7
	<0.707	0.707	1	1.414	2	2.828	4	5.657
DALI Fade Time (s)	8	9	10	11	12	13	14	15
	8	11.314	16	22.627	32	45.255	64	90.51

*Example:*

DALI fade time 4 = 2 s

DALI fade rate 10

→ transition time = 2 s \* 10 = 20 s

Duration = Value of scene 15 \* 0.25 s

DALI value in scene 15 = 85

→ duration = 85 \* 0.25 s = 21.25 s

Colour values = value scene 0 ... 14

DALI-value = 255 = scene will be skipped

The factory pre-set values for fade time and fade rate can be found in the following table:

## Factory configuration for stand-alone sequencer

DALI fade rate	DALI fade time	Transition time (s)	Duration (s)
15	4 (2,0 s)	30	1

Channel	Scene 0	Scene 1	Scene 2	Scene 3
R	254	180	10	10
G	10	10	10	254
B	10	180	254	254
Channel	Scene 4	Scene 5	Scene 6	Scene 7
R	10	254	254	254
G	254	254	150	254
B	10	10	10	254
Channel	Scene 8	Scene 9	Scene 10	Scene 11
R	255	255	255	255
G	255	255	255	255
B	255	255	255	255
Channel	Scene 12	Scene 13	Scene 14	Scene 15
R	255	255	255	4
G	255	255	255	4
B	255	255	255	4

Scenes 8 to 14 will be skipped as they have the value 255.

### Attention:

*In stand-alone operation several OT DALI 25 cannot be synchronised without overriding the DALI control.*

Example with OT DALI 25  
and DALI EASY

Above described options to control with DALI can be extended by OSRAM'S 4-channel lighting control system DALI EASY for example to store lighting scenes or to operate with IR remote control. The following application gives an example for wattages of more than 75 W:

### Application for LED-wattages of more than 75 W

To realise dynamic colour changes LINEARlight Colormix modules are used which are connected to the output terminals of an OT DALI 25. They are controlled via DALI EASY with IR remote control. The system wiring is shown in the figure below.

### System wiring to realise colour sequences with DALI 25/220-240/24RGB and DALI EASY

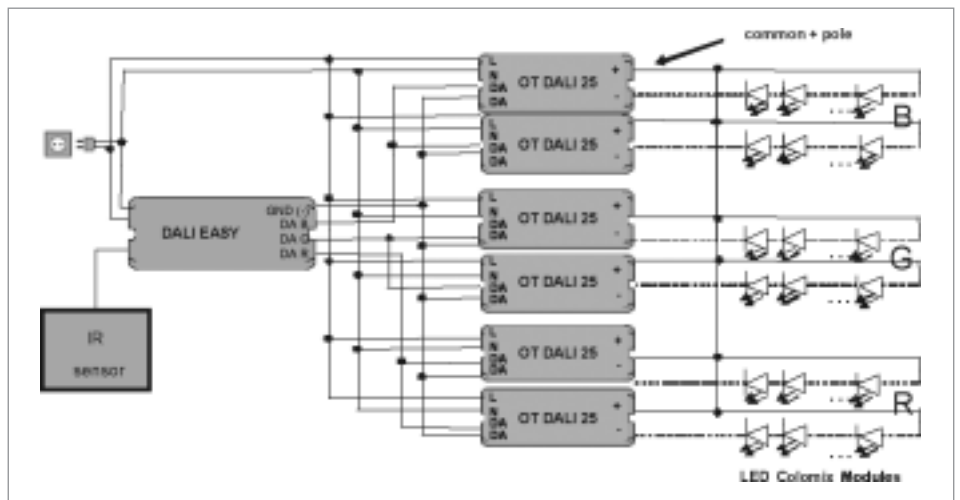

DALI EASY is designed to connect with max. 16 OT DALI 25 which corresponds to a maximum output wattage for LED-modules of  $16 * 25 = 400 \text{ W}$ .

The OT DALI 25 units are connected with a common + pole on the secondary side.

To connect LED-modules with higher wattages a master-slave connection has to be used. In this case, several DALI EASY are controlled via IR sensor and remote control.

The dimensioning of the necessary number of OT DALI 25 must be done for each colour separately.

*Example:* 15 pieces LINEARlight Colormix ~ 6.75 m

red	$1.8 \text{ W} \times 15 =$	27	W	→	2 OT DALI 25
green	$3.6 \text{ W} \times 15 =$	54	W	→	3 OT DALI 25
blue	$2.9 \text{ W} \times 15 =$	43.5	W	→	2 OT DALI 25
total		124.5	W	→	7 OT DALI 25

### 3.3 Planning and dimensioning of RGB systems

When dimensioning RGB systems some important decisions regarding the selection of components have to be made (see diagram below). After agreeing on the LED-modules to be used the decision regarding power supplies and control units is required. OSRAM DALI products offer a combined solution for LED-modules with 24 V input voltage and, in addition, the choice of separate controllers and power supplies for input voltages from 10 to 24 V.

## Alternative solutions of LED systems

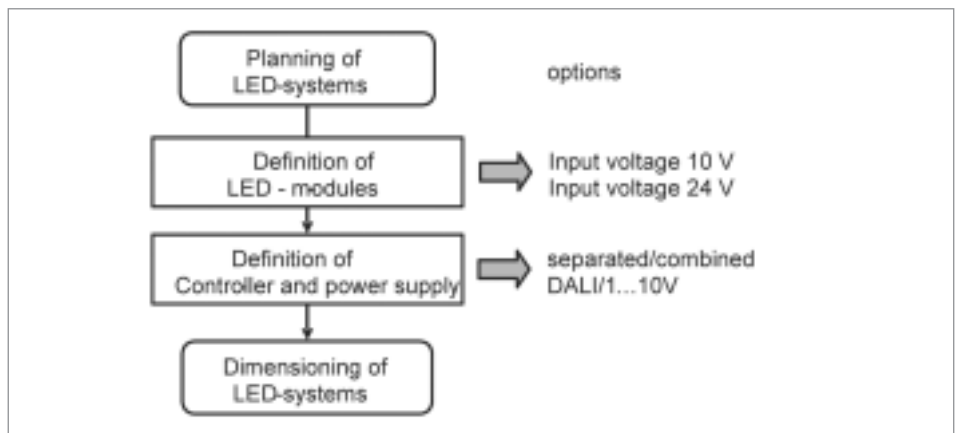

Once the decision has been made regarding the use of combined or separate controllers and power supplies or DALI and 1...10 V control units a further 3-step approach is required. First: the LED-module has to be defined. Second: the control unit must be selected. Third: a power supply has to be chosen.

However, the decisions cannot be made independently as the selection on a LED-module is linked to the choice of input voltage. For example, LINEARlight can be operated with a voltage of 10 V, LINEARlight Colormix require 24 V input voltage. The decision for a specific LED-module effects the selection of controllers and power supplies.

The following sections deal with the selection and calculation method for both cases: separate or combined power supply and control unit.

### **Realisation with separate control unit/power supply**

After having decided on the LED-module a control unit has to be selected. A suitable power supply must be chosen due to the wattage of the LED-modules and the losses of the control unit.

## Path of decision for dimensioning LED systems with separate controller and power supply

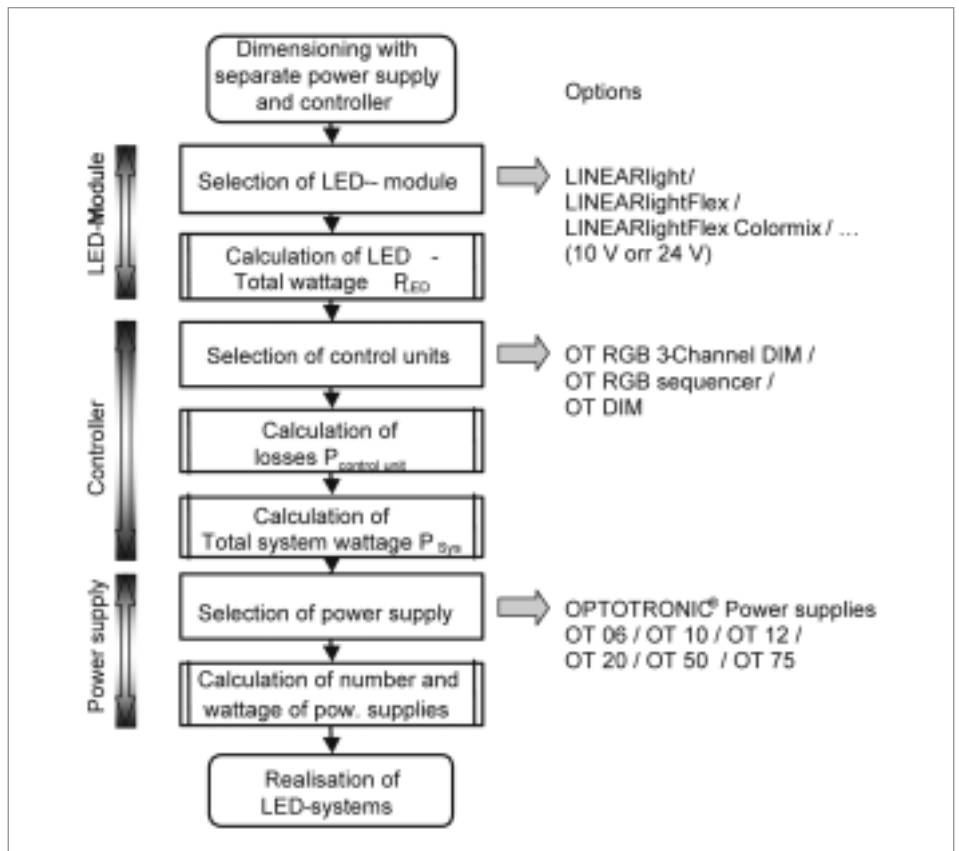

### Realisation with power supplies with integrated controller

An alternative solution to separate control units and power supplies is OT DALI 25/220-240/24RGB, a product which combines power supply and controller in one unit. A specialty is the output voltage of 24 V. LED-modules which can be connected to OT DALI 25 are for example LINEARlight Colormix and LINEARlight Colormix Flex. After having selected the desired LED-modules the total system wattage can be calculated directly from the wattage of LED-modules and with that the number of OT DALI 25 required.

### Path of decision for dimensioning of LED-systems for power supplies with integrated controller

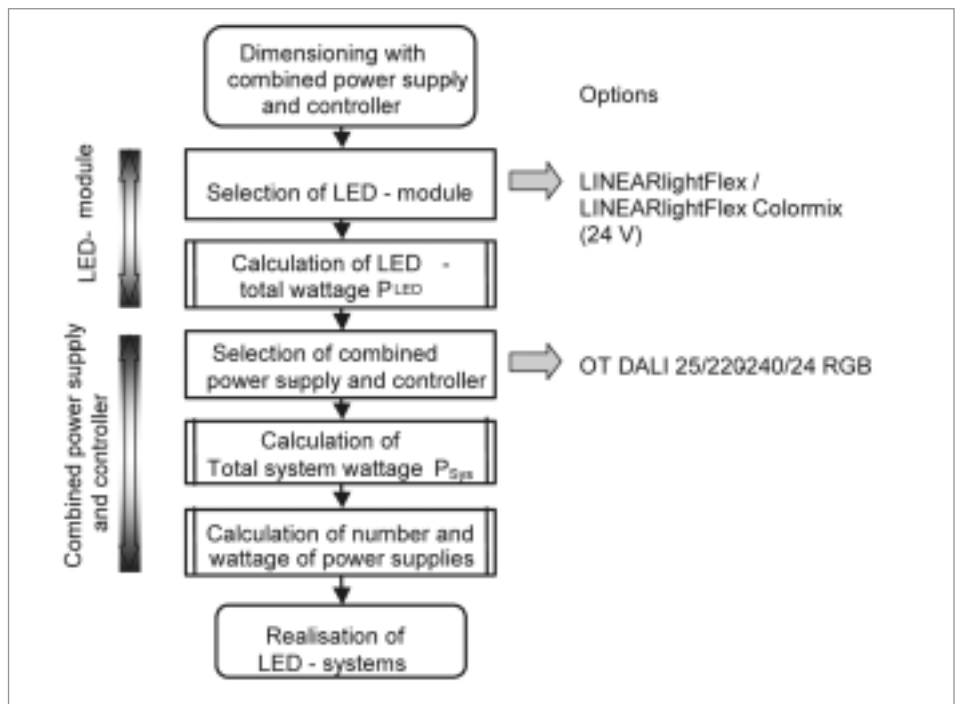

#### 3.3.1 LED-modules

The selection of a LED-module depends on the requirements of an installation (for example lumen output) and the desired length of the module. The length of a LED-module can be defined according to the needs.

To calculate the wattage of a LED-module of a defined length it is necessary to calculate in a first step the number of smallest divisible units of LED-modules which then leads in the total wattage of all smallest units used. To calculate the wattage as described above the following data are necessary:

LED-module	Length of module [mm]	Smallest divisible units	Wattage of module per colour [W]		
			R	G	B
LINEARlight Colormix	450	3	1.8	3.6	2.9
LINEARlight Colormix Flex	4000	20	12	24	19.2

*Attention:*

*A further separation into smaller module units is not possible. The smallest length of a unit is for example*

- LINEARlight Colormix: 150 mm
- LINEARlight Colormix Flex: 200 mm

Step 1: Calculation of the number of partial units of the LED-module needed.

$$\frac{\text{desired length of LED-modules in mm}}{\text{length of a module in mm}} \times \text{divisible units} = \text{number of partial units}$$

*Attention:*

*Please notice that only integer partial units can be used.*

$$\frac{\text{Number of partial units}}{\text{Divisible units of the LED-modules}} = \text{Number of modules}$$

Step 2: Calculation of the total LED wattage  $P_{LED}$

*Module wattage per colour in W x number of modules = wattage per colour*

*Total LED wattage  $P_{LED}$  = Sum of all wattages per colour*

### 3.3.2 Control unit

The choice of a control unit depends on the total wattage of the selected LED-module (see chapter 7.4). The losses of the control unit have to be added to the wattage of the LED-module to obtain the total wattage of the system. The following steps have to be carried out.

Step 1: Definition of the losses of a control unit  $P_{V; \text{control unit}}$

The losses depend on the total wattage of the LED-module. You can find the losses of a control unit in the diagram below.

#### Wattage of OT-DIM

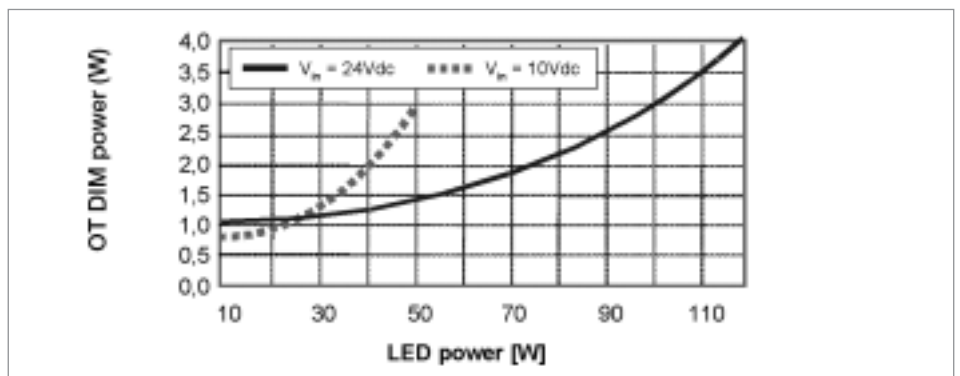



### Wattage of OT RGB 3-Channel DIM, OT RGB Sequencer

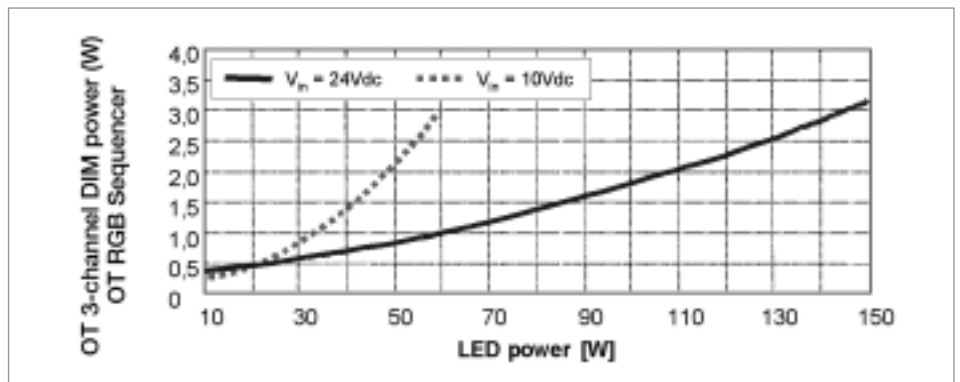

Attention:

The losses of 3-channel units are split between the individual colours i.e. a third of the losses for each colour. Therefore, the required total wattage is calculated as:

losses per colour + LED-wattage per colour =  
required total wattage per colour

Step 2: Calculation of system wattage  $P_{Sys}$

The total system wattage is composed of the LED wattage and the losses of the used controllers:

$$\text{Total system wattage } P_{Sys} = P_{V, controller} + P_{Led}$$

### 3.3.3 Power supply

The choice of a power supply depend on its maximum power. The maximum power of the used power supply must either cover the total system wattage or the power supplies must be operated in parallel allowing total wattages of more than 75 W.

Calculation of the needed number of power supplies

$$\frac{\text{Required total wattage per colour}}{\text{Max. output wattage of power supply}} = \text{Number of power supplies per colour}$$

$$\text{Total number of power supplies per colour} = \text{Number of needed power supplies}$$

### 3.3.4 Example how to calculate the wattage of a RGB-system

A project requires 8.5 m of LINEARlight Colormix Flex. The following paragraph explains how to calculate the wattage dimensioning of an application following the calculation steps described above.

Basis for the calculation is the desired total module length of 8.5 m using LINEARlight Colormix Flex with 24 V input voltage. The lighting system shall be operated with separate controllers and power supplies.

LED-module

**Calculation of the number of smallest LED-module units and wattage of the LED-modules** (see also § 3.3.1, page 46)

Calculation of partial units of the required LED-module

Required LED length: 8.5 m

Length of LINEARlight Colormix Flex module: 4.0 m

Divisible into 20 units

$$\frac{8500 \text{ mm}}{4000 \text{ mm}} \times 20 = 42,5 \text{ partial units}$$

*Attention:*

*As it is only possible to use integer partial units, this value has to be rounded up or off. In the example above 43 units shall be used adding to a total length of 8.60 m.*

$$\frac{43}{20} \quad 2.15 \text{ modules}$$

Therefore, 3 LINEARlight Colormix Flex modules have to be ordered.

Calculation of the total LED wattage  $P_{LED}$

Module wattages per colour in W: R 12 W / G 24 W / B 19,2 W

For the RGB colours the calculation results in the following total wattages:

Wattage red:

$$12 \text{ W} \times 2.15 = 25.8 \text{ W}$$

Wattage green:

$$24 \text{ W} \times 2.15 = 51.6 \text{ W}$$

Wattage blue:

$$19.2 \text{ W} \times 2.15 = 41.3 \text{ W}$$

This adds up to the following total wattage of the module:

$$P_{LED} = 25.8 \text{ W} + 51.6 \text{ W} + 41.3 \text{ W} = 118.7 \text{ W}$$

### Control unit **Calculation of the losses of the control units and system wattage**

(see also section 3.3.2) There are two choices of control units: OT DIM or OT RGB 3-Channel DIM

Calculation of the losses of a control unit  $P_{V, \text{control unit}}$

When choosing OT DIM (one unit per colour) from the diagram in 3.3.2 the losses of the control unit for this calculation example (system wattage 118.7 W composed of single wattages for R/G/B = 25.8 W/51.6 W/41.3 W) read as:

$$P_{V, \text{control unit}} = 1.1 \text{ W} + 1.5 \text{ W} + 1.3 \text{ W} = 3.9 \text{ W}$$

Calculation of the total system wattage  $P_{\text{Sys}}$

The losses of the control unit  $P_{V, \text{control unit}}$  and the total LED wattage  $P_{\text{LED}}$  add up to the total system wattage  $P_{\text{Sys}}$ :

$$P_{\text{Sys}} = P_{V, \text{control unit}} + P_{\text{LED}} = 3.9 \text{ W} + 118.7 \text{ W} = 122.6 \text{ W}$$

Power supply **Calculation of the required number of power supplies**  
(see also 3.3.3)

Calculation of the required number of power supplies

The total system wattage comes to 122.6 W which can be provided by more than one OT 75 E with an output wattage of 75 W operated in parallel:

$$\frac{122.6 \text{ W}}{75 \text{ W}} = 1.6$$

The required number of power supplies is 2.

### Solutions with system wiring

*Solution:* The two power supplies are operated in parallel and supply the three OT DIM controllers. Each of the three OT DIM is used to control one colour. The total module length of 8.5 m is connected to the outputs of the OT DIM control units.

### Example of system wiring

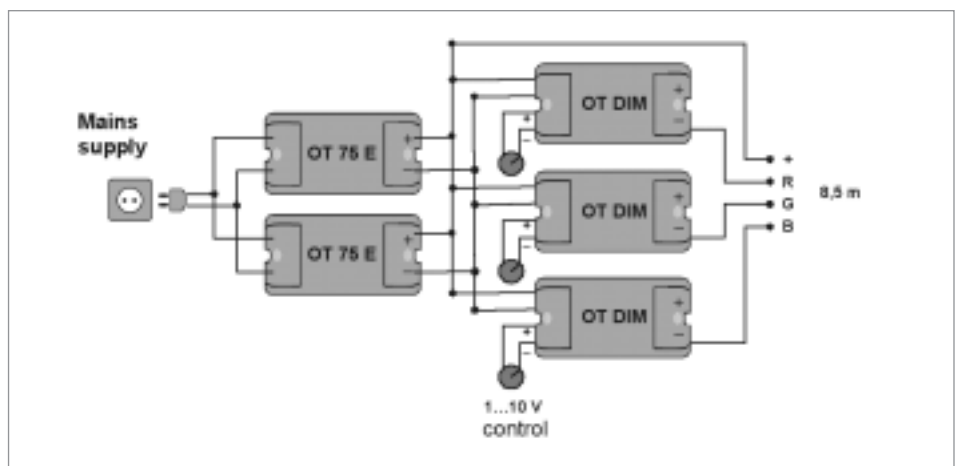

# 4. Light Management Systems

## Why light management?

### Economic and demand-oriented light!

Light touches our emotions and makes us „feel good“ physically as well as mentally, at home, at work or at leisure-time activities. The „right“ light at the „right“ place and at the „right“ time stimulates us to perform better and supports our well-being. Therefore, in addition to technical and architectural lighting designs, today's holistic objective of value-added lighting solutions includes also light management.

Light management creates dynamic lighting solutions by changing light output, light colour and direction of light. Instead of a static „on-off“ solution, a more economic and demand-oriented lighting control becomes the focus of attention, from daylight control and lighting scenes at the touch of a button to dynamic lighting applications.

Saving energy and increasing the comfort of light is no longer a contradiction. Modern, efficient and more and more „natural“ artificial lighting is complementing daylight applications. Convincing advantage: Every user can control his or her desired lighting level individually.

To connect light management systems to lighting installations two standard interfaces have been established, 1...10 V and DALI. That makes it possible to include LED in general lighting applications.

## 4.1 1...10 V interface

The 1...10 V interface has become a standard also for OPTOTRONIC® power supplies

### Features of 1...10 V interfaces

- The control happens via a DC voltage signal from 10 V (maximum light output; control wires open) to 1 V (minimum light output; control wires short-circuited).
- The control voltage is provided by the ECG (max. current: 0.6 mA per ECG).
- The voltage on the control wires are galvanically separated from the mains cables, however not complying with SELV.
- Units operated on different phases can be dimmed by one controller.

Due to the features of 1...10 V interfaces the following points have to be considered:

- Connect all control wires with the right polarity (+/-).
- The control wires are galvanically separated from the mains cables, however not complying with SELV. For installation purposes use only cables and terminals approved for 230 V.
- The control voltage can easily be limited upwards and downwards; several controllers can be combined.
- Testing an installation regarding the correct operation should be done as follows:

1. Turn on the installation with the control wires open: LED-modules should run with nominal wattage.
  2. Short-circuit the control wires (wire bridge). LED-modules should be dimmed to minimum light output (0).
- The only purpose of 1...10 V interfaces is dimming the LED-modules, switching is done via mains cables.
  - Please pay attention to the maximum load of the used potentiometer/dimmer of the control unit (switching output and 1...10 V output).
  - Any installed control unit must be able to carry the current provided by the ECG into the control wires and to reduce the control voltage.

This requirement is fulfilled by all potentiometers dimensioned accordingly and by any OSRAM control components. Standard power supplies or converters etc. do not necessarily have this feature! To test a controller connect it, dim down to the lowest light level and measure the voltage in the control cables. The value should be less than or equal to 1 V.

OPTOTRONIC® power supplies cannot be dimmed via mains cables (for example by leading edge phase cutting or control impulse)!

#### **4.1.1 Installation instructions**

- All components of the main circuit and the control circuit must be designed for 250 V against earth.
- Don't use „bell wires“ as control wires, because the 1...10 V control voltage does not comply with SELV.
- Detailed information regarding selection of cables and installation can be found in the latest editions of the international or national standards for electrical installations. According to DIN VDE 0100 part 520 section 528.11 main circuits and auxiliary circuits can be routed in parallel even if the voltage of the auxiliary circuits is lower than the voltage of the main circuits.

The following points are important for cable routing:

- Only cables may be used which are insulated according to the highest operating voltage to be found in the particular installation. Alternatively, each conductor in a multi-wire cable is insulated against the cable voltage next to it.
- When routing wires in tubes or ducts for electrical installation only cables of a main circuit and the according auxiliary circuit may be routed together.
- In one cable several main circuits including the according auxiliary circuits may be combined.

## 4.1.2 Control units

For lighting controls commercial potentiometers or OSRAM's hand held controller DIM MCU are available.

### Potentiometer

The simplest way to control lighting is through potentiometers (available through electric wholesale) which must be accordingly dimensioned. The OPTOTRONIC® control unit is providing the control voltage required for the potentiometer. The resistance depends on the number  $n$  of the connected units and can be calculated according to the following formula:

$$R_{Poti} = \frac{100 \text{ k}\Omega}{n}$$

If the resulting value cannot be found in the table of resistance values the higher value next to it should be used, otherwise a 100% control of LED-modules is not possible (comment: by using a higher value the full range of the potentiometer may perhaps not be usable for lighting control).

The potentiometer must be at least designed for a wattage  $P_{Poti}$  of  $n \times 2,8$  (mW). To switch the lighting installation on/off a mains switch is required. When connecting the potentiometer one has to pay attention that the full lighting level is reached when turning the potentiometer to the right. The choice of potentiometer be it linear or logarithmic depends on the desired dimming characteristics. To adapt the brightness to the human eye a logarithmic potentiometer should be selected.

When connecting more than two 1...10 V units the installation of OSRAM's hand held controller DIM MCU is recommended.

The following diagram gives an example for a wiring with potentiometer connected to the control input of an OT DIM.

### Wiring diagram with potentiometer

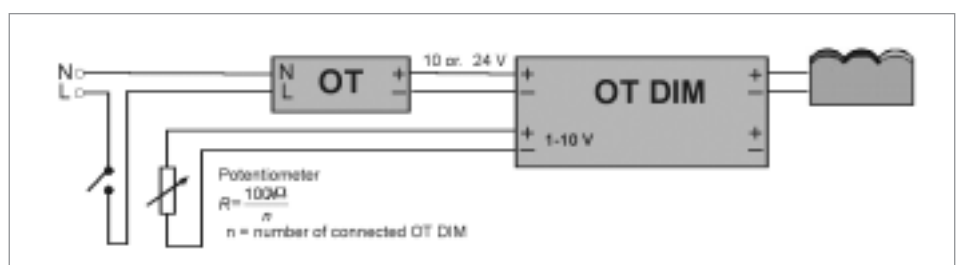

Hand held controller DIM  
MCU

The hand held controller DIM MCU is a standard solution for lighting control with one service station (for example in small to mid-size rooms with one door). Wiring diagram see chapter 3.1.2. With one hand held controller a maximum of fifty 1...10 V units can be controlled.

A push button is integrated into the hand held controller (galvanically insulated from the lighting control). This contact is able to control relays in order to simultaneously switch units belonging to different circuits.

In the following diagram you find the wiring with DIM MCU connected to the control inputs of OT DIM units with OT DIM operated in parallel.

**Wiring diagram with DIM MCU for installations with max. 50 OT DIM**

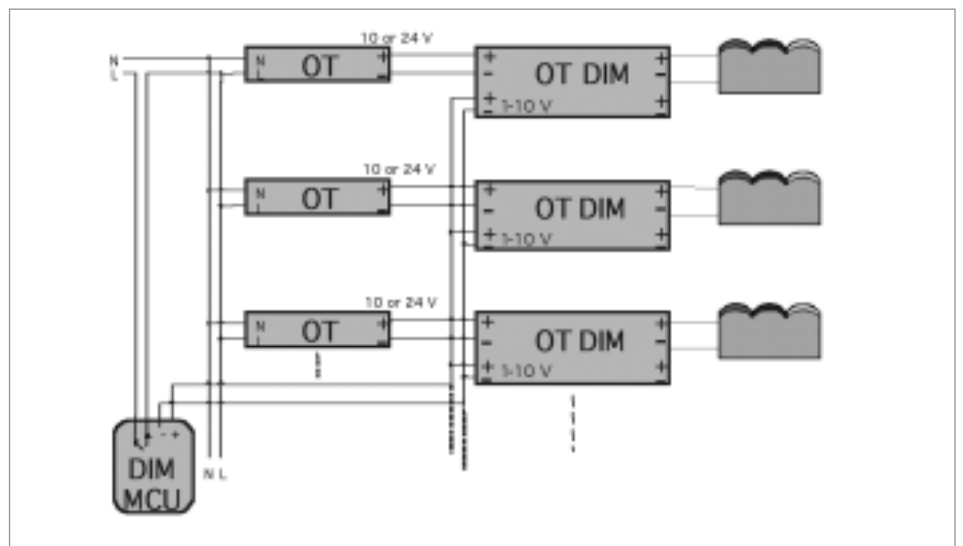

Technical data of the hand held controller DIM MCU	
Reference:	DIM MCU
Dimensions:	For flush-type box $\varnothing = 55/60$ mm
Rotary axis:	$\varnothing = 4$ mm, $l = 14$ mm and 6 mm thread
Type of fixing:	Claws or screws
Permissible ambient temperature:	-20 °C to +50 °C
Terminals:	Screw terminals
Permissible wire cross-section:	Max. 1,5 mm <sup>2</sup>
Terminal -:	- (control signal)
Terminal +:	+ (control signal)
Terminal and mains connection	switching contact 230 V, mains voltage not required
Effects of incorrect wiring 230 V at control terminal: reversing +/-:	Fuse defective or total failure, always minimum luminous flux
Range of control signal:	1...10 V DC (voltage source in OT DIM)
Load capacity of the hand held controller for brightness control:	Max. 40 mA or max. 50 OT DIM or 16 signal amplifiers DIM SA
Switching contact:	250 V/6 A
Fuse:	Fine fuse F500/H250
Cover and rotary button:	Appropriate products are available from Berker (2891), Gira (30900) or Jung (240-10)

*Attention:*

*An installation combining 2 or more hand held controllers is not possible. To dim larger groups of 1...10 V units a signal amplifier DIM SA is needed if the max. load of the controllers or sensors is exceeded (see table below).*



### Maximum Load of 1...10 V control output

Control unit	Number of OT DIM
DIM IRM	50
DIM PICO	5
DIM MICO	100
DIM MULTI	50
DIM MULTI 2	30
DIM MCU P	50
DIM SA	100
DIM SC	10

### Application of the signal amplifier DIM SA

DIM SA is a signal amplifier for 1...10 V signals which can be used in combination with other 1...10 V controllers and can be directly connected with the outputs of these controllers.

In complex light management systems DIM SA is integrated between the control unit and the OT DIM units (see diagram).

### Block diagram DIM SA application

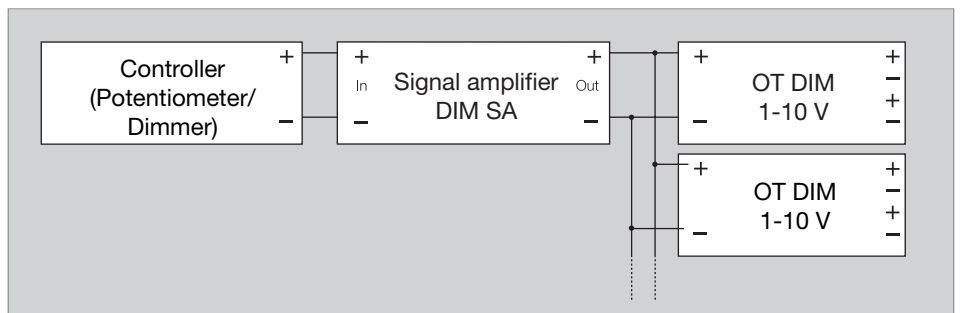

When integrating a DIM SA all control wires of OT DIM run in parallel (see diagram below).

### Wiring diagram when using DIM MCU with DIM SA to control OT DIM

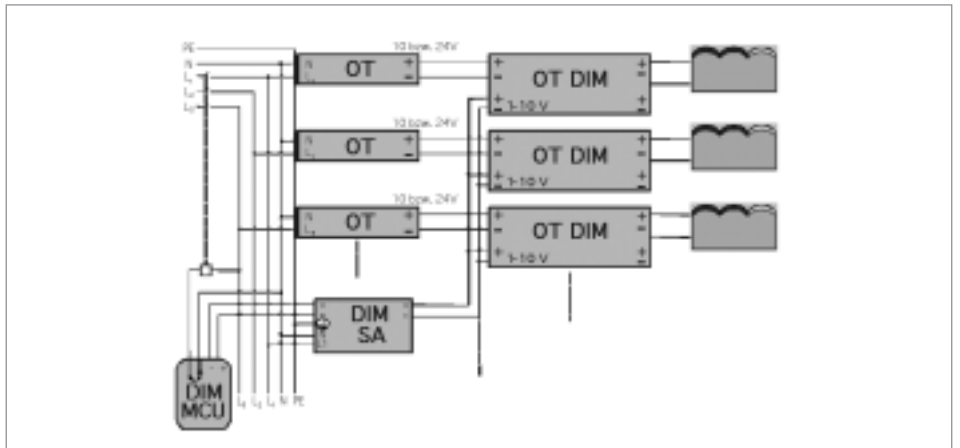

#### Attention:

Up to one hundred 1...10 V units or 33 additional signal amplifier can be connected to the output of the DIM SA where the load of one DIM SA adds up to as much as three 1...10 V units. Combinations of 1...10 V units and further signal amplifiers are possible. In installations with more than 100 units several signal amplifiers must be operated in series as cascade connection.

#### DIM SA



#### 4.1.3 Analogue output

In principle, the external control via 0...10 V analogue output (for example PC board) is possible. The control module must be able to carry the current provided by the 1...10 V unit and to reduce the control voltage to at least 1 V.

For that, the analogue output must fulfill two conditions:

- It must be potential-free which means it may not be galvanically in contact with parts or components which are subject to SELV- requirements (test voltage 3000 V, for parts with earth connection the test voltage is 1500 V).
- The analogue output has to take the control current of the 1...10 V unit. Usually it is not known how much current an analogue output can take. However this can always be checked with an adaptation circuit.

### Wiring diagram for application of DIM SA on an analogue output

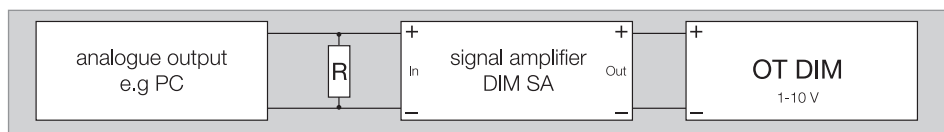

## 4.2 DALI interface

### Requirements of modern lighting technology

Today's lighting installations must be able to provide more than just „On/off“-functions. Modern lighting is part of the room comfort and at the same time part of energy saving concepts in facility management systems. The most important requirement is the generation of easy-to-recall lighting scenes often combined with occupation sensor or daylight control. In addition, the system must be easy to handle and allow for feedback to building management systems (for example lamp failure).

### DALI – the simple and flexible solution for lighting applications

Modern lighting technology need flexible and also simple systems focussing on lighting control with only a few, cost effective components, little wiring effort and user friendly handling. For this, the European lighting industry has developed a new digital interface for lighting systems: DALI – Digital Addressable Lighting Interface.

DALI is closing the gap between the conventional 1...10 V technology and the more complex bus systems. DALI offers a very simple local solution for lighting tasks as well as a very complex solution if integrated as sub-system into building management.

### What is DALI?

DALI has become the new, independent interface standard for dimmable electronic control gear and is standardised in IEC62386. Consequently, DALI has been developed from existing ECG-interfaces offering more features and simpler handling.

### The DALI principle

In the most flexible way, two wires control up to 64 DALI units either separately or together and in up to 16 groups.

The lighting installation is switched or dimmed via the control wires which means there is no relay necessary. The power supply is able to store important information such as lamp status and provides this information to the control unit.

DALI is the interface for all professional lighting solutions. OSRAM offers a large range of DALI power supplies and controllers for fluorescent lamps, compact fluorescent lamps, halogen lamps and LED.

## 4.2.1 Features

Simplified lighting design with DALI at a glance

### **Simple planning and flexible layout for possible changes**

A single 2-wire control for up to 64 power supplies means:

It is not necessary to define the lighting groups during the planning phase. This can be done at a later stage simply with the help of the control unit. When operated with DALI, the luminaire groups do not depend on the wiring scheme. The grouping of the individual luminaires is done by the control unit and can be changed at any time.

### **Simple installation and reduction of components**

DALI installations are done with commercial installation material for mains voltage. The two unused wires in 5-wire cables (i.e. NYM 5x1.5 mm<sup>2</sup>) can be used for a DALI interface regardless of the polarity. The control wires must only be approved for mains voltage, no special cables are necessary.

The mains voltage phases of powers supply and controller do not have to match. In addition, prior to starting the system, the ECG can be switched on/off via the connected fuse.

No relays for turning on the luminaires are required. Switching and dimming is carried out exclusively via control wires.

### **Synchronised changes of lighting scenes**

Even if there are different dimming values during the starting phase or different light sources are combined, a change in lighting scenes is synchronized by DALI. In this case, all light sources reach their new light level at the same time.

### **Lamp status on demand – status report from the ECG**

DALI power supplies issue a lamp status report to the control unit where it is displayed thus making it possible to report lamp defects or light level of lamps.

### **No group wiring**

A DALI system addresses each ECG individually, digitally and trouble-free. When initialising an installation, each ECG is assigned to a group. Individual ECGs can be part of up to 16 groups and, therefore, belong to several groups at the same time. The ECGs can be addressed individually, in groups or all together.

It is possible, to change the formation of groups at any time without touching the hardwires.

### **Integrated scene storage**

The ECG store the light levels per lighting scene assigned to a corresponding group. Independent of any definition of groups the individual ECG can store up to 16 different light levels. Transitions between scenes are synchronised meaning that all ECG start and finish the transition at the same time by operating with different dimming speed.

## DALI topology

The DALI topology is very simple (see diagram below). DALI devices are wired either in series or in parallel without paying attention to the formation of any group.

The only thing not permitted is a circular wiring here marked with X. In this case, the signal would “run in circles” disturbing the communication. End resistances are not required.

## Principle of a DALI topology

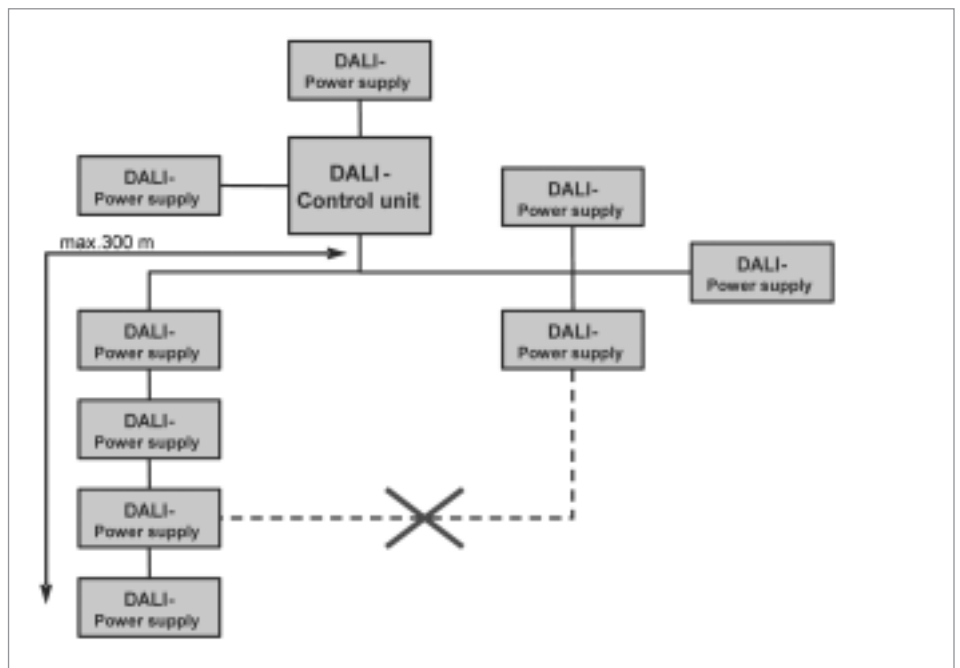

## Shared intelligence

During the initialising process DALI ECG store the following data:

- Affiliation to lighting groups (max. 16 groups, multiple assignments possible)
- Individual address for direct contact to each ECG (max. 64)
- Lighting levels for individual scenes (max. 16) plus special settings such as
  - Dimming speed
  - Behaviour when voltage at the interface is interrupted (emergency lighting)
  - Behaviour when mains voltage is back on

In addition to the options above, it is always possible to address all units together even without initialising (broadcast).

#### 4.2.2 DALI-Lighting controls from OSRAM

The brochure „A systematic approach to lighting management: LMA from OSRAM“ gives detailed information about all actual OSRAM components of light management systems including the most important features, functions, applications as well as technical and ordering data. You can download the brochure under [www.osram.com](http://www.osram.com).

Technical details of DALI and of LMS-products can be found in our Technical Guide „DALI“.

#### 4.2.3 DALI EASY

DALI EASY, the lighting control system, is operating on the principle of additive colour mixing with four individually dimmable channels. The heart of a DALI-EASY system is the control unit with four separate digital control outputs (DALI). One input is reserved for IR detectors and a further connection for the standard installation push button which can switch the lighting fixtures or colour sequence centrally.

This system has been designed for easy to use dynamic colour-mix possibilities. For further information please see our DALI guide (edition 2005).

The 4-channel light management system with programmable RGB-sequencer is pre-wired and therefore, does not need to be addressed. DALI EASY stores up to four lighting scenes. Commands are sent as DALI-broadcast per channel.

Every control unit can operate up to 16 DALI ECG, the system is modular and can be extended. It is operated via IR remote control and standard push button.

Real Plug & Control, no programming required.

In combination with three OT DALI 25/220-240/24RGB, DALI EASY is the ideal product for variable colour mix applications.



The diagram explains the integration of DALI EASY for 4 lighting groups.

### Integration of DALI EASY for 4 lighting groups

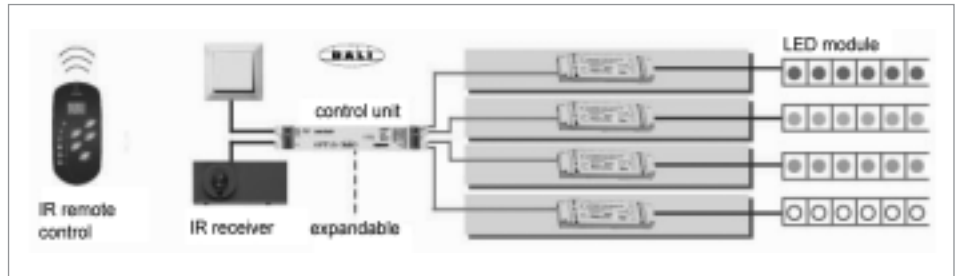

### 4.2.4 Connection with DALI CON

The DALI-1...10 V-converter can also control 1...10 V-units such as OT DIM. An example of controlling three OT DIM via DALI controller can be seen below.

### Wiring diagram with DALI CON to control OT DIM

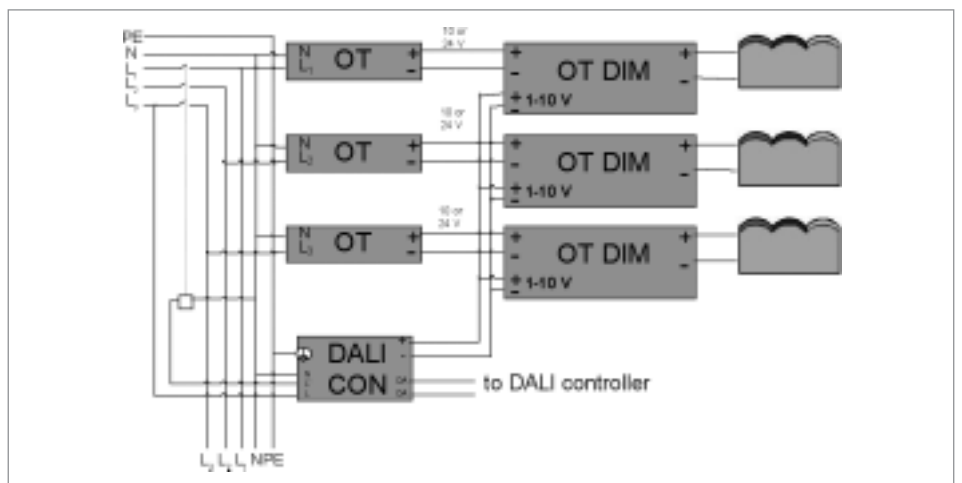

### DALI CON

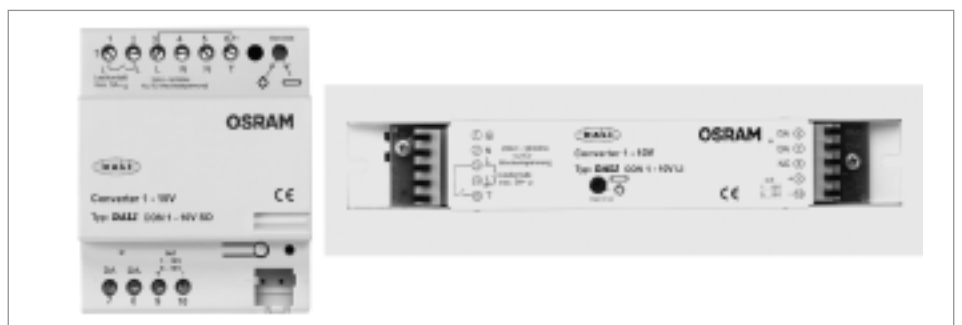

### 4.3 DMX interface or building management systems

DMX-interfaces, originally developed for stage and studio applications, offer a large variety of control options such as light levels, focussing, light colour or turning angles.

Equipped with more than 4 channels DMX-controls are suitable for high transmission speed for complex lighting scene sequences and they can be programmed via software and/or mixer station.



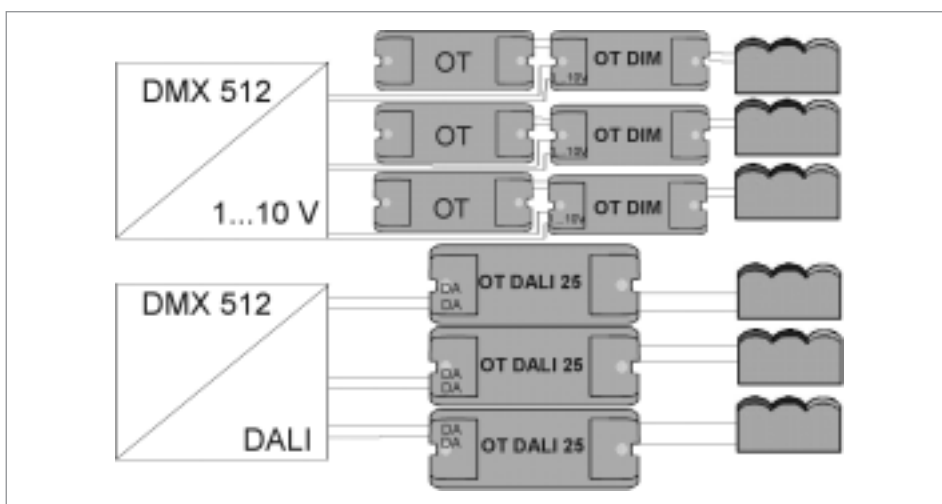

The disadvantage of DMX-interfaces is their high cost, their need for consulting and the necessity to use a shielded, three wire cable according to AES-EBU-standard.

The following diagram shows how to integrate OSRAM power supplies into DMX-systems.

#### Integration of OSRAM power supplies via DMX-interface



Both, 1...10 V as well as DALI units, can be integrated into DMX installations via the corresponding gateways (units which „translate“). The following table summarizes suppliers of DMX-gateways and their products.

Gateway	DMX?512/DALI-Gateway		DMX?512/1...10V?Gateway	
<b>Product ?</b>	DLI-4-DIN-230	30004B-H	PWM-4-DIN-230 PAO-4-DIN-10	12-Channel DMX-Demultiplexer 3012C-EP
<b>Manufacturer</b>	KWL-Lighting, Oberhaching	Soundlight, Hannover	KWL-Lighting	Soundlight, Hannover
<b>Address www</b>	<a href="http://www.kwl-lighting.de">http://www.kwl-lighting.de</a>	<a href="http://www.soundlight.de">http://www.soundlight.de</a>	<a href="http://www.kwl-lighting.de">http://www.kwl-lighting.de</a>	<a href="http://www.soundlight.de">http://www.soundlight.de</a>
				
<b>Function</b>	Gateway-Function to DMX512-systems	Gateway-Function to DMX512-systems	Gateway-Function to DMX512-systems	Gateway-Function to DMX512-systems
<b>Control</b>	max. 10 EVG per output in 1 group	max. 8 ECG per output in 1 group	max. 50 ECG per channel	max. 3 ECG per channel
<b>Other</b>	4 DALI-outputs	4 DALI-outputs	4 1...10 V-outputs	12 1...10 V-outputs



## 5. Installation Instructions

### 5.1 Maximum lengths of low voltage cables

When defining the maximum lengths of secondary cables you have to consider the limitations with respect to radio interference and with respect to voltage drop.

#### 5.1.1 Maximum lengths of low voltage cables due to radio interference

All OPTOTRONIC® products comply with the limit values for radio interference according to EN 55015 IEC.

Due to reasons for radio interference the maximum length of secondary cables may not exceed the values mentioned in the data sheets. For the following power supplies the maximum permitted cable length leading to the LED-modules is described in the table below:

Power supply	Max. permitted cable length
OT 6 10C	10 m
OT 6 24C	10 m
OT 10 L	10 m
OT 12	4 m
OT 20	10 m
OT 20 S	10 m
OT 50 / OT 75	10 m
OT 50E / OT 75 E	10 m
OT DALI 25	10 m

In specific applications it may be necessary to exceed the max. permitted cable length. In this case special EMC filters can be applied on the secondary side (10 V and 24 V).

For example, a ferrite close to the output terminals can reduce the effect of radio interference significantly.

The trade offers simple and easy-to-use solutions (see pictures below). A possible ferrite is available under the description TDK ZCAT3035-1330-BK (part No.).

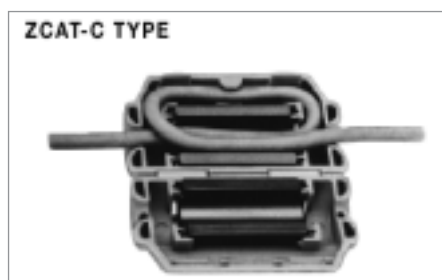

### 5.1.2 Maximum lengths of low voltage cables due to voltage drops

Besides the requirements for electromagnetic compatibility the planning of LED lighting installations has also to consider the resistance of secondary cables. LED-modules will not emit any light if the voltage drop across the secondary wiring exceeds a certain value.

The following formula takes this fact into consideration:

$$L_{\max} \leq \frac{1}{2\rho} \times (V_{OT} - V_{DIM} - V_{LED}) \times \frac{V_{LED}}{P_{LED}}$$

The following parameters effect the calculation of the maximum permitted length of secondary cables:

- Cross section of cables and their resistance per length unit as well as the change of the copper resistance with the temperature ( $\rho \times [W/m]$ ).
- OPTOTRONIC® output voltage ( $V_{OT} = 10.5 \text{ V}$  and  $24 \text{ V}$ )
- Minimum input voltage of LED-modules ( $V_{LED} = 10 \text{ V}$  and  $23 \text{ V}$ )
- Possible effect of dimming modules such as OT DIM (voltage drop  $V_{DIM} \sim 0.3 \text{ V}$ )
- Maximum wattage of LED-modules ( $P_{LED}$ )

Table with values of specific resistance for  $1.5 \text{ mm}^2$  and  $0.75 \text{ mm}^2$  (at copper temperature of  $50 \text{ }^\circ\text{C}$ ):

cable $1.5 \text{ mm}^2$		cable $0.75 \text{ mm}^2$	
$\rho$ [ $\Omega/\text{km}$ ]	$1/\rho$ [ $\text{m}/\Omega$ ]	$\rho$ [ $\Omega/\text{km}$ ]	$1/\rho$ [ $\text{m}/\Omega$ ]
13.6	73.8	29.1	34.3

*Examples:*

OT 20/230-240/24, 14 EFFECTlight blue (OS-WL01A-B) and  $1.5 \text{ mm}^2$  cable (cable temperature:  $20 \text{ }^\circ\text{C}$ ):

$$L_{\max} \leq \frac{1}{2} \times 73.8 \text{ m}/\Omega \times (24 \text{ V} - 0.3 \text{ V} - 23 \text{ V}) \times \frac{23 \text{ V}}{14 \times 1.3 \text{ W}} = 32.6 \text{ m}$$

OT 20/230-240/24, 14 EFFECTlight blue (OS-WL01A-B) and  $0.75 \text{ mm}^2$  cable (cable temperature:  $20 \text{ }^\circ\text{C}$ ):

$$L_{\max} \leq \frac{1}{2} \times 34.3 \text{ m}/\Omega \times (24 \text{ V} - 0.3 \text{ V} - 23 \text{ V}) \times \frac{23 \text{ V}}{14 \times 1.3 \text{ W}} = 15 \text{ m}$$

According to this calculation the cable length is limited to  $10 \text{ m}$  because of radio interference and not because of cable resistance reasons!

To guarantee a reliable and good installation especially when using higher wattages it is absolutely necessary to take these factors carefully into account and to adapt the installation to the specific circumstances.

## Maximum length of low voltage cables for individual types of power supplies

Maximum lengths of low voltage cables for individual OPTOTRONIC®-power supplies are calculated for different voltage drops according to the diagrams below. It is important to know that the maximum length is **proportional to the wiring cross** section.

All diagrams are based on a cross section of 1.5 mm<sup>2</sup>. If you plan to use wiring with a cross section of 2.5 mm<sup>2</sup> the maximum cable length is extended by the factor.

$$\frac{2,5}{1,5} = 1,66$$

*Attention:*

*Always pay attention to the regulation for radio interference suppression!*

OT 6/100-240/10  
OT 6/100-240/24  
OT 10/220-240/10 L

Wiring cross section  $\Delta\varnothing = 1.5 \text{ mm}^2$ , massive leads **without** dimmer

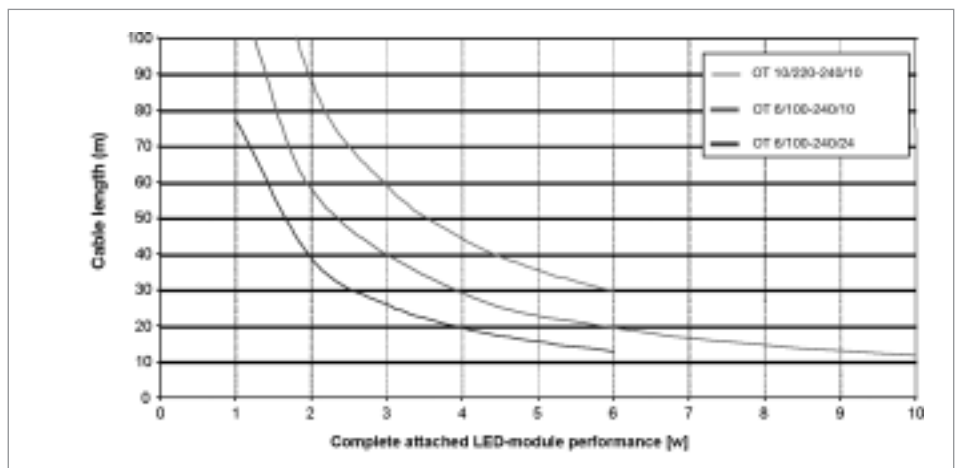

OT 6/100-240/10  
 OT 6/100-240/24  
 OT 10/220-240/10 L

Wiring cross section  $\varnothing = 1.5 \text{ mm}^2$ , massive leads **with** dimmer

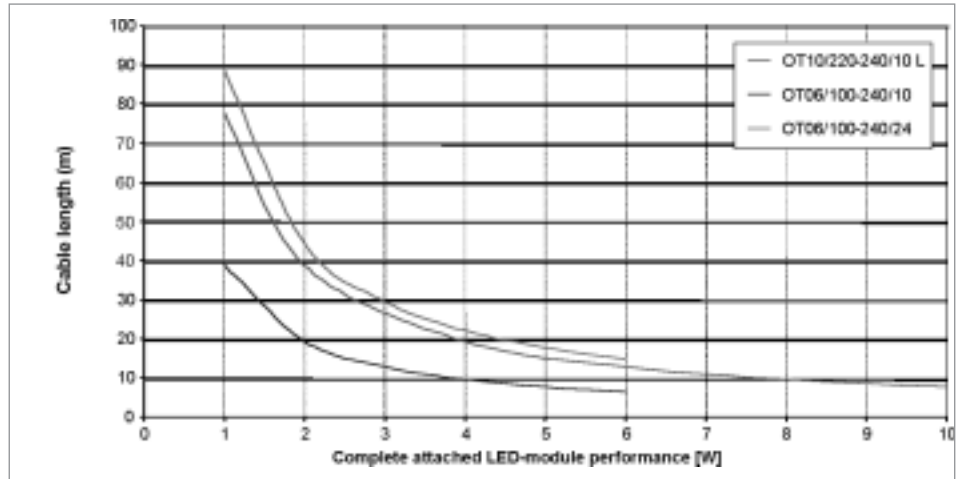

OT 12/230-240/10  
 OT 20/230-240/24  
 OT 20/120-240/24 S  
 OT DALI 25/220-240/24 RGB

Wiring cross section  $\varnothing = 2.5 \text{ mm}^2$ , massive leads **without** dimmer

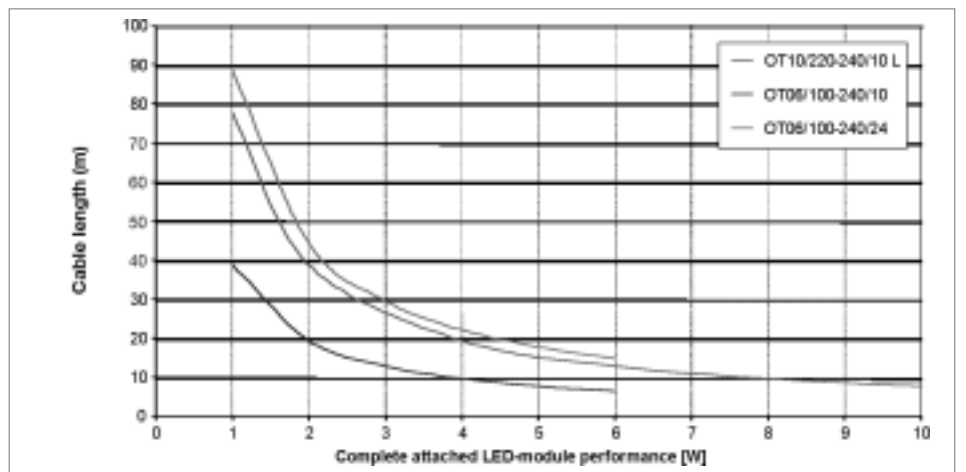

(\*) wattage for one colour

OT 12/230-240/10  
 OT 20/230-240/24  
 OT 20/120-240/24 S

Wiring cross section  $\varnothing = 2.5 \text{ mm}^2$ , massive leads **with** dimmer

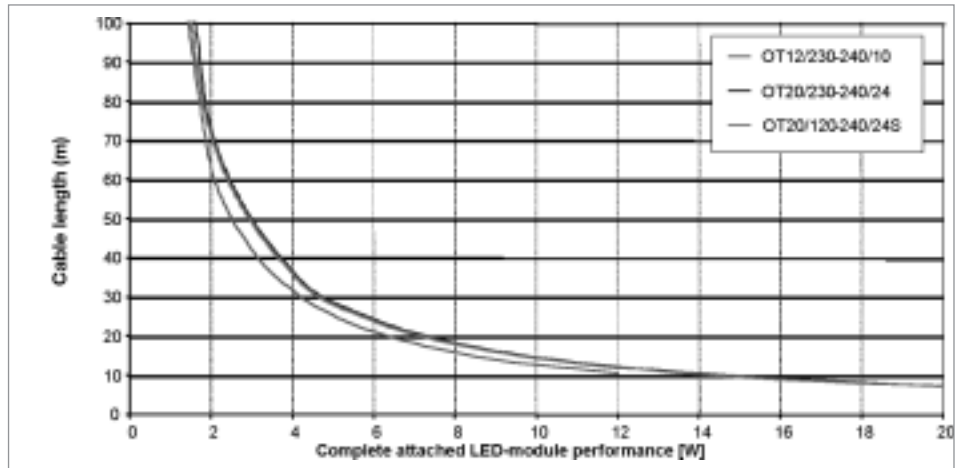

OT 50/220-240/10  
 OT 75/220-240/24  
 OT 50/120-277/10E  
 OT 75/120-277/24E

Wiring cross section  $\varnothing = 2.5 \text{ mm}^2$ , massive leads **without** dimmer

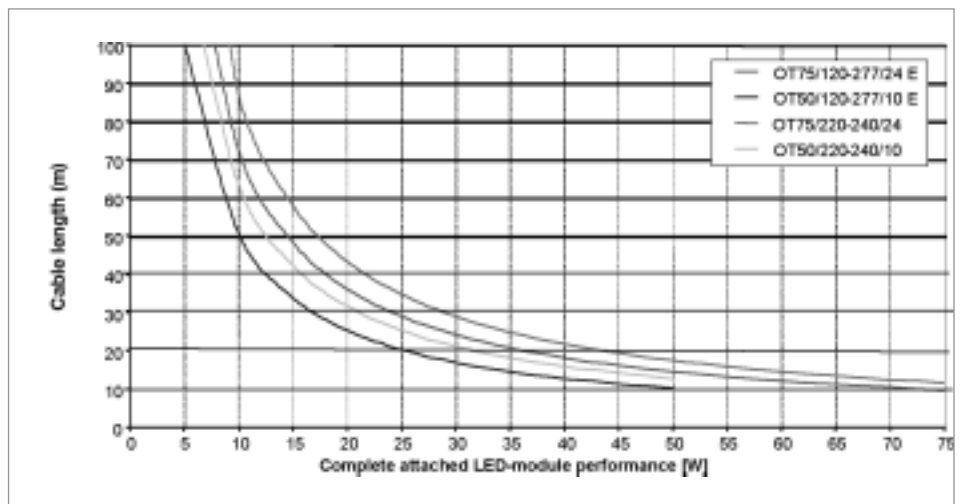

OT 50/220-240/10  
 OT 75/220-240/24  
 OT 50/120-277/10E  
 OT 75/120-277/24E

Wiring cross section  $\varnothing = 2.5 \text{ mm}^2$ , massive leads **with** dimmer

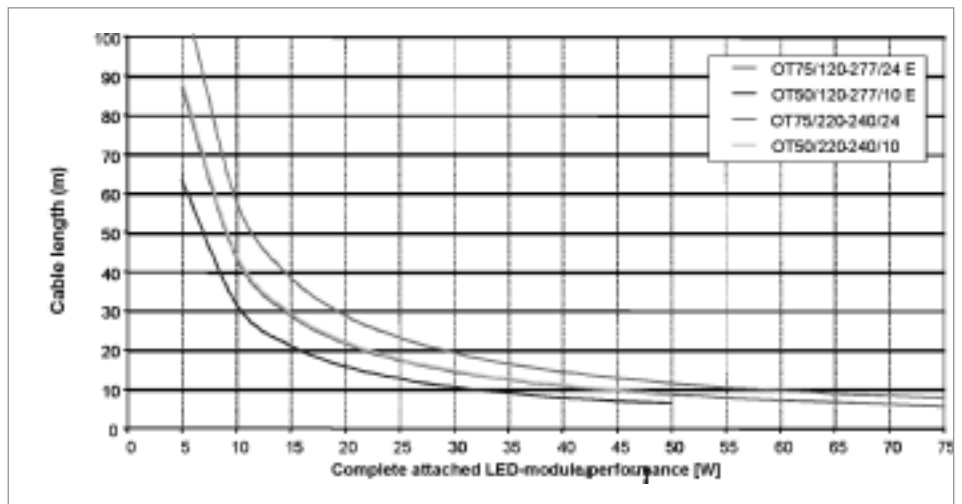

### 5.1.3 Wiring of LED systems as bus systems

An extension of the maximum length of secondary cables is possible if the LED system is wired as a bus system which means a supply cable with branches to the individual modules.

For a bus system the maximum cable length is calculated according to the following „rule of thumb“:

$$L_{Ges} = 2 \cdot L_{max}$$

(valid for evenly distributed load:  $L_2 = L_3 = \dots = L_n$ )

*Attention:*

*If the installation is wired in series and not as a bus system, the voltage drops per LED-module are added to a total.*

Then  $L_{Ges}$  must be  $\ll L_{Max}$ .

#### Example of a bus system wiring

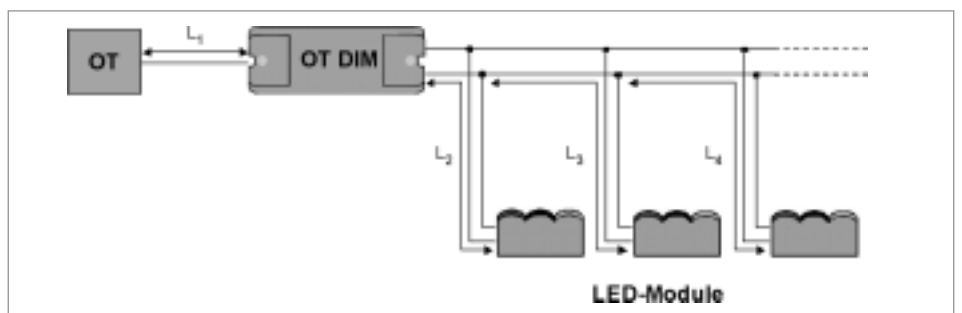

$$\text{Total length of secondary cables } L_{Ges} = L_1 + L_2 + \dots + L_n$$

## 5.2 Recommended cables

The following cables are recommended for power supplies:

	Mains cable	Secondary cable
OT 6/10	Bunched conductor with strain relief and end splice	Tinned stranded wire with strain relief
OT 6/24	Bunched conductor with strain relief and end splice	Tinned stranded wire with strain relief
OT08/24	0.5 mm <sup>2</sup> to 1.5 mm <sup>2</sup> massive leads. 0.5 mm <sup>2</sup> to 1 mm <sup>2</sup> flexible	0.5 mm <sup>2</sup> to 1.5 mm <sup>2</sup> massive leads. 0.5 mm <sup>2</sup> to 1 mm <sup>2</sup> flexible
OT 10/10 L	0.5 mm <sup>2</sup> to 1.5 mm <sup>2</sup> single-wire cable 0.5 mm <sup>2</sup> to 1 mm <sup>2</sup> multi-wire cable	0.5 mm <sup>2</sup> to 1.5 mm <sup>2</sup> single-wire cable 0.5 mm <sup>2</sup> to 1 mm <sup>2</sup> multi-wire cable
OT 12/10	NYM 3 x 1.5 mm <sup>2</sup> / H03VV – F2 x 0.75	NYM 3 x 1.5 mm <sup>2</sup> H03VV – F 2 x 0.75
OT 20/24	NYM 3 x 1.5 mm <sup>2</sup> / H03VV – F2 x 0.75	NYM 3 x 1.5 mm <sup>2</sup> H03VV – F 2 x 0.75
OT 20/24 S	NYM 3 x 1.5 mm <sup>2</sup> / H03VV – F2 x 0.75	NYM 3 x 1.5 mm <sup>2</sup> H03VV – F 2 x 0.75
OT 50/10	DIN 57281 H03VV-F 2x0.50; H03VV-F 2x0.75; H05VV-F 2x0.75; Nym 3x1.5	DIN 57281 H03VV-F 2x0.75; H05VV-F 2x0.75; H05VV-F 2x1.00; H05VV-F 2x1.5; H05VV-F 2x2.5
OT 75/24	DIN 57281 H03VV-F 2x0.50; H03VV-F 2x0.75; H05VV-F 2x0.75; Nym 3x1.5	DIN 57281 H03VV-F 2x0.75; H05VV-F 2x0.75; H05VV-F2x1.00; H05VV-F 2x1.5; H05VV-F 2x2.5
OT 9/350	0.5 mm <sup>2</sup> to 1.5 mm <sup>2</sup> massive leads. 0.5 mm <sup>2</sup> to 1 mm <sup>2</sup> flexible	0.5 mm <sup>2</sup> to 1.5 mm <sup>2</sup> massive leads. 0.5 mm <sup>2</sup> to 1 mm <sup>2</sup> flexible
OT 9/350E	0.5 mm <sup>2</sup> to 1.5 mm <sup>2</sup> massive leads. 0.5 mm <sup>2</sup> to 1 mm <sup>2</sup> flexible	0.5 mm <sup>2</sup> to 1.5 mm <sup>2</sup> massive leads. 0.5 mm <sup>2</sup> to 1 mm <sup>2</sup> flexible

For OPTOTRONIC®, OT 12/10, OT20/24 and OT 20/24 S (mains cables of type NYM 3 x 1.5 mm<sup>2</sup>/H03VV – F2 x 0.75) please pay attention to the following stripping lengths:

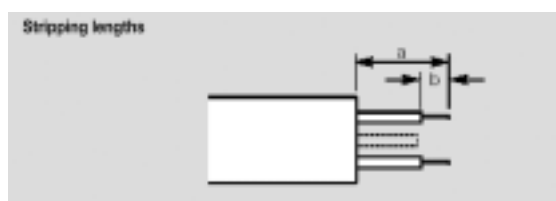

a = 12 mm

b = 6 mm

### 5.3 Cable routing

To ensure good radio interference suppression and maximum safety the following rules for cable routing should be noted:

1. Mains and LED-module cables should never be routed in parallel. Keep output cables and mains cables as far away from one another as possible (e.g. 5 to 10 cm). This avoids mutual interference between mains and lamp cables.
2. Lay output cables away from earthed metal surfaces (if possible several cm) to reduce capacitive interference.
3. Keep mains cables in the luminaire as short as possible to reduce interference.
4. Don't route mains cables too close to the power supply (this applies in particular to through-wiring).
5. Avoid crossing mains cables and LED-module cables. Where this is not possible, cables should cross at right angles (to avoid HF interference on the mains cable).

#### Cable routing of OPTOTRONIC® and LED-modules

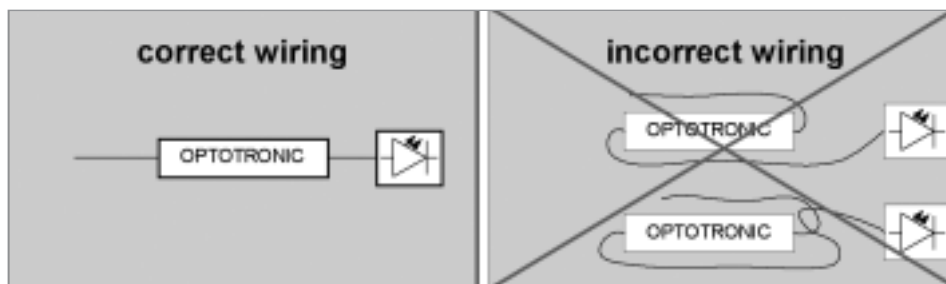

6. Cable penetrations through metal components must never be left unprotected and should be fitted with additional insulation (sleeve, grommet, edge protector, etc.).

Dimming units on the secondary side such as OT DIM usually do not effect the radio interference.

Electronic power supplies can be installed in a wide variety of places, including suspended ceilings, furniture, luminaires and tube systems. Installation on wood is permitted as these products fulfil the requirements for  mark according to VDE 0710 and VDE 0100 part 559.

To avoid noise from dimming, OT dimming units should be installed in a way that no vibration is transferred to any resonance surface.



## 6. Examples of applications

The following pictures are examples for a variety of lighting options designed with LED-modules from OSRAM.

### 6.1 Architectural Lighting



Illumination of a bridge in Rijeka, Croatia



Architectural lighting with EFFECTlight

### 6.2 Illuminated signs

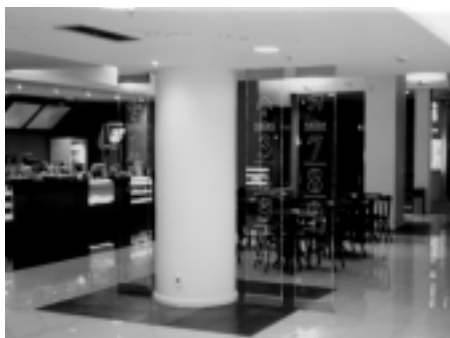

Signs with blue LINEARlight modules



Illuminated signs

### 6.3 Orientation and safety lighting



Safety lighting Gewandhaus Leipzig



## 6.4 Shop lighting



Background illumination of glass fields  
in a shoe shop in Sao Paolo



Decorative lighting with LED-modules  
Watches of underground stations in Denmark

## 6.5 Mood and effect lighting



Effect lightning in the bar of the hotel  
„Bayerischer Hof“, in Munich with  
LINEARlight Colormix and LINEARlight Colormix Flex

# 7. Appendix

## 7.1 Description of type field



### Product description

The product description informs about the nominal values of a product type: for example: OT 50/120-277/10 E:

OT	OPTOTRONIC®
50	Maximum output wattage [W]
120-277	Permitted mains voltage range [ $V_{AC}$ ]
10	For constant voltage products: Output voltage to supply LED-modules [ $V_{DC}$ ] For constant current products: Output current to supply LED-modules [mA]

Extensions to the product description:

C	Circular
E	Exterior (suitable for outdoor application))
L	Long
S	Square

### Standards

EN61347	safety
EN550015	radio interference
EN61000	harmonic content
EN61547	immunity
EN60929	performance



conformity with European standards



VDE approval mark (electrical safety)



VDE approval mark for EMC (electromagnetic compatibility)

**cURus**

Observance US-Specifically safety regulations

## OSRAM labels

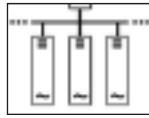

Can be switched in parallel on the secondary side



Units with electronically controlled constant output voltage

## Other labels



Earth connector



Luminaire with discharge lamps for installation on hardly inflammable material.



Installation on inflammable materials with unknown properties where temperatures under normal conditions do not exceed 95 °C and under abnormal conditions do not exceed 115 °C.



max. housing temperature in case of abnormal operation (110°)

Lambda

Power factor

$t_a$

Ambient temperature

$t_c$

Case temperature (measuring point)

## 7.2 Abbreviations

**AllnGaP**

Aluminium Indium Gallium Phosphate

**DALI**

Digital Addressable Lighting Interface

**ECG**

Electronic Control Gear

**InGaN**

Indium Gallium Nitrite

**IP**

Ingress Protection

**LED**

Light Emitting Diode

**OT**

OPTOTRONIC

**PWM**

Pulse Width Modulation

**RMS**

Root Mean Square

**SELV**

Safe Extra Low Voltage

**SPS**







Smart Power Supply

### 7.3 IP types of protection for luminaires

All luminaires are classified into types of protection regarding moisture and ingress of solids. The lowest protection class does not protect against moisture or dust, however it guarantees that without tools no live parts can be touched.

Luminaires without any information about type of protection are classified as IP 20. The following table informs you about IP types of protection, their description and symbols

#### IP types of protection according to DIN EN 60529

Protection against foreign bodies in addition to shock-hazard protection			Protection against water		
1 <sup>st</sup> digit			2 <sup>nd</sup> digit		
Digit	Symbol	Description	Digit	Symbol	Description
2	–	Protection against ingress of solid foreign bodies with a diameter greater than 12 mm	0	–	No special protection
4	–	Protection against ingress of solid foreign bodies with a diameter greater than 1 mm	3	 rain-proof	Protection against water falling at any angle up to 60 degrees.
5	 dust protected	Protection against harmful dust deposits. The ingress of dust is not completely prevented but the dust must not enter in such large amounts that the operation of the luminaire is impaired.	4	 splash-proof	Protection against water sprayed at any angle at the luminaire.
			5	 jet-proof	Protection against a jet of water from a nozzle directed at the luminaire at any angle.
6	 dust tight	Protection against the ingress of dust; dust-tight	7	 water-tight	Protection against water if the luminaire is submerged in water under defined time and pressure conditions.
			8	 pressure water-tight	The luminaire is suitable for permanent submerging in water under conditions defined by the manufacturer

## 7.4 Data sheets





### 7.4.1 10 V constant voltage OPTOTRONIC® power supplies

Reference	OT 6/220-240/10CE	OT 10/220-240/10L	OT 12/230-240/10	OT 50/220-240/10	OT 50/120-277/10E
LED-module	With respect to the output parameters (see section .2.1. page 5ff.)				
Mains voltage, nominal	220 V-240 V	220 V-240 V	230 V-240 V	220 V-240 V	120 V-277 V
Nominal current	0.15 A <sub>eff</sub> bei 240 V	0.13 A <sub>eff</sub>	0.07 A <sub>eff</sub>	0.26 A <sub>eff</sub>	0.26 A <sub>eff</sub>
Mains frequency	0/50/60 Hz	50/60 Hz	50/60 Hz	0/50/60 Hz	0/50/60 Hz
Output voltage	DC voltage, 10.5 V ± 0.5 V electronically controlled, ripple max. ± 0.4 V				
Max. module wattage	6 W	10 W	12 W	50 W	50 W
Losses	Max. 2.3 W	Max. 3 W	Max. 3.5 W	Max. 5 W	Max. 5 W
Partial load	0.2 W – 6 W	0.4 W – 10 W	0.4 W – 12 W	0.4 W – 50 W	0.4 W – 50 W
Power factor		0.97	0.9	0.9	> 0,95
DC voltage operation	176 V-264 V DC, suitable for emergency lighting according to VDE 0108				
safety	EN 61046 / EN 61347-2-13				
Performance	IEC 62384				
Radio interference	EN 55015				
Harmonic content	EN 61000-3-2				
Flickering	EN 61000-3-3				
Immunity	EN 61547				
Temperature range	-20 °C to +50 °C	-20 °C to +50 °C	-20 °C to +50 °C	-20 °C to +50 °C	-25 °C to +60 °C
Galvanic insulation between primary and secondary side	3 kV <sub>eff</sub>	3 kV <sub>eff</sub>	3 kV <sub>eff</sub>	3 kV <sub>eff</sub>	3.75 kV <sub>eff</sub>
Open circuit test	Yes				
Short circuit protection	Yes, automatic shut-down, reversible				
Overload protection	Yes, automatic shut-down, reversible				
Overheating protection	Yes, automatic shut-down, reversible				
Connections	Pre-wired	Screw terminals	Screw terminals	Screw terminals	Pre-wired
Length of secondary cables	Max. 10 m	Max. 10 m	Max. 4 m	Max. 10 m	Max. 10 m
Power line	Bunched wire with end splice and strain relief	Massive leads	NYM 3 x 1.5 mm <sup>2</sup> / H03W - F2 x 0.75	DIN 57281 H03W-F 2x0.50; H03W-F 2x0.75; H05W -F 2x0.75; Nym 3x1.5	DIN 57281 H03W -F 2x0.50; H03W-F 2x0.75; H05W-F 2x0.75; Nym 3x1,5
Wiring cross section, primary	0.75 mm <sup>2</sup>	0.5 mm <sup>2</sup> – 1.5 mm <sup>2</sup> massive leads 0.5 mm <sup>2</sup> – 1 mm <sup>2</sup> flexible leads	0.75 mm <sup>2</sup> bis 1.5 mm <sup>2</sup>	DIN 57281 H03W-F 2x0.50; H03W-F 2x0.75; H05W -F 2x0.75; Nym 3x1.5	0.83 mm <sup>2</sup> , massive leads
Wiring cross section, secondary	0.5 mm <sup>2</sup>	0.5 mm <sup>2</sup> - 1.5 mm <sup>2</sup> massive leads 0.5 mm <sup>2</sup> - 1 mm <sup>2</sup> flexible leads	0.75 mm <sup>2</sup> bis 1.5 mm <sup>2</sup>	DIN 57281 H03W-F 2x0.75; H05W-F 2x0.75; H05W -F 2x1.00; H05W-F 2x1.5; H05W-F 2x2.5	0.83 mm <sup>2</sup> , massive leads
Dimensions (l x b x h)	52 mm x 50 mm x 19 mm	150 mm x 22 mm x 22 mm	109 mm x 50 mm x 35 mm	220 mm x 46.2 mm x 43.6 mm	241 mm x 43 mm x 30 mm
Approvals	CE	CE	CE	CE	CE cURus

## 7.4.2 24 V constant voltage OPTOTRONIC® power supplies



Reference	OT 6/220-240/24CE	OT 8/200-240/24	OT 20/230-240/24	OT 20/120-240/24 S	OT 75/220-240/24	OT 75/120-277/24E
LED-modules	With respect to the output parameters (see section.2.1, page 5ff.)					
Mains voltage, nominal	220 V-240 V	200 V-240 V	230 V-240 V	120 V-240 V	220 V-240 V	120 V-277 V
Nominal current	0.15 A <sub>eff</sub> bei 240 V	0.1 A <sub>eff</sub> bei 230 V	0.2 A <sub>eff</sub>	0.35A <sub>eff</sub> bei 120 V 60Hz 0.23A <sub>eff</sub> bei 240 V 50Hz	0.37 A <sub>eff</sub>	0.37 A <sub>eff</sub>
Mains frequency	0/50/60 Hz	0/50/60 Hz	0/50/60 Hz	50/60 Hz bei 120 V 0/50/60 Hz bei 240 V	0/50/60 Hz	0/50/60 Hz
Output voltage	DC voltage, 24 V ± 1.0 V electronically controlled, ripple max.:±0.2 V					
Max. module wattage	6 W	8 W	20 W	20 W	75 W	75 W
Losses	Max. 2.3 W	Max. 2.5 W	Max. 4 W	Max. 4 W	Max. 8 W	Max. 8 W
Partial load operation	0.2 W – 6 W	0 W – 8 W	0.9 W – 20 W	0.9 W – 20 W	0.9 W – 75 W	0.9 W – 75 W
Power factor	0.5	0.8	0.8	0.5 bei 120 V 60 Hz / 0.4 bei 240 V 50 Hz	0.97	0.97
DC voltage operation	176 V-264 V DC suitable for emergency lighting according to VDE 0108					
Safety	EN 61046, IEC 61347-2-13	EN 61046, IEC 61347-2-13	EN 61046, IEC 61347-2-13	EN 61046 / EN61347-2-13, EN 61347-2-13 UL 1310 recognized	EN 61347-2-13, UL 1310, UL 48, UL879A, SAIM	EN 61347-2-13, UL 1310, UL 48, UL879A, SAIM
Radio interference	EN 55015	EN 55015	EN 55015	EN 55015, FCC 47 Part 15 Class B	EN 55015	EN 55015, FCC 47 Part 15 Class A
Harmonic content	EN 61000-3-2					
Flickering	EN 61000-3-3					
Immunity	EN 61547	EN 61547	EN 61547	EN 61547	EN 61547	EN 61547, ANSI C62.41 Class B
Temperature range	-20 °C to +50 °C	-20 °C to +50 °C	-20 °C to +45 °C	-20 °C to +50 °C	-20 °C to +50 °C	-25 °C to +60 °C
Galvanic insulation between primary and secondary side	3 kV <sub>eff</sub>	3 kV <sub>eff</sub>	3 kV <sub>eff</sub>	3 kV <sub>eff</sub>	3 kV <sub>eff</sub>	3,75 kV <sub>eff</sub>
Open circuit test	Yes					
Short circuit protection	Yes, automatic shut-down, reversible					
Overload protection	Yes, automatic shut-down, reversible					
Overheating protection	Yes, automatic shut-down, reversible					
Connections	Pre-wired	Screw terminals	Screw terminals	Screw terminals	Screw terminals	Pre-wired
Length of secondary cables	Max. 10 m	10 m with 1.5 mm <sup>2</sup> massiv leads, 80 cm for luminaires of class I	Max. 10 m	Max. 10 m	Max. 10 m	Max. 10 m
Power line	Flexible leads with strain relief and end splice	Terminal & functional earth	NYM 3 x 1.5 mm <sup>2</sup> / H03VV – F2 x 0.75	NYM 3 x 1.5 mm <sup>2</sup> / H03VV – F2 x 0.75	DIN 57281 H03W-F 2x0.50; H03W-F 2x0.75; H05W – F 2x0.75; Nym 3x1.5	DIN 57281 H03W-F 2x0.50; H03W-F 2x0.75; H05W-F 2x0.75; Nym 3x1.5
Wire cross section, primary	0.75 mm <sup>2</sup>	0.5 mm <sup>2</sup> bis 1.5 mm <sup>2</sup> massiv leads, 0.5 mm <sup>2</sup> bis 1 mm <sup>2</sup> Litze	0,75 mm <sup>2</sup> bis 1,5 mm <sup>2</sup>	0,75 mm <sup>2</sup> bis 3,3 mm <sup>2</sup> (AWG 12)	DIN 57281 H03W-F 2x0.50; H03W-F 2x0.75; H05W – F 2x0.75; Nym 3x1.5	0.83 mm <sup>2</sup> , massive leads
Wire cross section, secondary	0.5 mm <sup>2</sup>	0.5 mm <sup>2</sup> - 1.5 mm <sup>2</sup> massive leads, 0.5 mm <sup>2</sup> - 1 mm <sup>2</sup> flexible leads	0.75 mm <sup>2</sup> - 1.5 mm <sup>2</sup>	0.75 mm <sup>2</sup> - 2.0 mm <sup>2</sup> (AWG 14)	DIN 57281 H03W-F 2x0.75; H05W-F 2x0.75; H05W – F 2x1.00; H05W-F 2x1.5; H05W-F 2x2.5	0.83 mm <sup>2</sup> , massive leads
Dimensions (l x b x h)	52 mm x 50 mm x 19 mm	80 mm x 40 mm x 22 mm	109 mm x 50 mm x 35 mm	60 mm x 60 mm x 30,5 mm	220 mm x 46,2 mm x 46,3mm	241 mm x 43 mm x 30 mm
Approvals	CE	CE	CE	CE	CE	CE





### 7.4.3 Constant current OPTOTRONIC® power supplies

Reference	OT 9/100-120/350E	OT 9/200-240/350
LED-modules	DRAGON LED-modules and LED operated with 350 mA DC	DRAGON LED-modules and LED operated with 350 mA DC
Supply	Constant current	Constant current
Mains voltage, nominal	100 - 120 V <sub>eff</sub>	200 - 240 V <sub>eff</sub>
Nominal current	0.1 A	0.1 A
Mains frequency	50/60 Hz	0/50/60 Hz
Output voltage	1.8 - 25V <sub>DC</sub>	1.8 - 25 V <sub>DC</sub>
Output current	DC current 350 ± 17.5 mA, electronically controlled	
Max. module wattage:	8.5 W	
Max. number of LED	max. 6 DRAGON LED in W, B, G or max. 9 DRAGON LED in A, Y	
Max. losses.	2.7 W	
Partial load operation	0.6 ... 8.5 W	0 ... 8.5 W
Permitted input voltage range	90 – 122 VRMS	180 - 254 VRMS
Power factor	0.5	0.5
DC voltage operation	No	Yes (176 - 264 V)
Safety	UL 1310	EN 61347-2-2; IEC 61347-2-13
Performance		IEC 62384
Radio interference	FCC 47 part 15 class A	EN 55015
Harmonic content	EN 61000-3-2	EN 61000-3-2
Immuniyt	ANSI C 62.41 class B	EN 61547
Temperature range	-20 °C to +50 °C	
Galvanic insulation between primary and secondary side	3 kVRMS	
Open circuit test	Yes	
Short circuit protection	Yes, automatic shut-down, reversible	
Overload protection	Yes, automatic shut-down, reversible	
Overheating protection	Yes, automatic shut-down, reversible	
Dimmable	no	
Connections	Push-in type terminals	
Connections on the primary side	Main terminal + functional earth	
Wire cross section, primary	0.5 mm <sup>2</sup> - 1.5 mm massive leads 0.5 mm <sup>2</sup> - 1 mm <sup>2</sup> flexible leads	
Connections on the secondary side	LED-module	
Wire cross section, secondary	0.5 mm <sup>2</sup> - 1.5 mm massive leads 0.5 mm <sup>2</sup> - 1 mm <sup>2</sup> flexible leads	
Length of secondary cables	Max. 10 m with 1.5 mm <sup>2</sup> massive leads for luminaires of protection class II, max. 80 cm for luminaires of protection class I	
Dimensions (l x b x h)	80 mm x 40 mm x 22 mm	
Protection class with regard to insulation	II suitable for luminaires of protection class I: Functional earth connection recommended	
Approvals	 cURus	  



## 7.4.4 OPTOTRONIC® control units

Reference	Constant voltage	Constant current
	OT DIM	OT 9/10-24/350 DIM
LED-modules	With respect to the output parameters: LINEARlight, LINEARlight Flex, BACKlight, COINlight, MARKERlight, EFFECTlight and equivalent modules	DRAGON LED-modules and LED operated with 350 mA DC
supply	Constant voltage	Constant current
Nominal input voltage range.	10.5 - 24 V <sub>DC</sub>	10 - 24 V <sub>DC</sub>
Max. input voltage range	9.5 - 25 V <sub>DC</sub>	9 - 32 V <sub>DC</sub>
Max. input current	5.3 A	1.1 A <sub>DC</sub>
Output voltage		0 - 24.5 V <sub>DC</sub>
Control voltage	1...10 V <sub>DC</sub>	1...10 V <sub>DC</sub>
Max. control current.	0.6 mA	0.6 mA
Galvanic insulation between primary side, control input and LED-module output	3 kVeff (SELV-equivalent)	
Dimming mode	PWM	
Operating frequency	135 Hz typ.	244 Hz typ.
Dimming range	0 - 100 %	
Max.output current	5 A depending on the load	DC current 350 ± 17.5 mA, electronically controlled
Losses (Dimming rate = 95 % load)	Max. 3 W at 10.5 VDC	
Max. 4 W at 24 VDC	Max. 2.5 W	
Max. module wattage:	50 W for 10 V-modules,	
120 W for 24 V-modules	8.5 W	
Safety	EN 61046 / IEC 61347-2-2 and IEC 61347-2-13, UL 508	EN 61347-2-2; EN 60598; IEC 61347-2-13
Performance	IEC 62384	
Radio interference	EN 55015	EN 55015
Immunity	EN 61547	EN 61547
Temperature range	-20 °C - +50 °C	-20 °C - +50 °C
Open circuit test	Yes	Yes
Short circuit protection	in combination with OPTOTRONIC®-power supply	Yes, automatic shut-down, reversible
Overload protection	Yes, automatic shut-down, reversible	Yes, automatic shut-down, reversible
Overheating protection	Yes, automatic shut-down, reversible	Yes, automatic shut-down, reversible
Wire cross section	0.75 mm <sup>2</sup> - 1.5 mm <sup>2</sup>	
Wire cross section, primary	NYM 3x1.5 mm <sup>2</sup> / H03VV-F2x0.75 mm <sup>2</sup>	0.5 mm <sup>2</sup> - 1.5 mm <sup>2</sup> massive leads 0.5 mm <sup>2</sup> - 1 mm <sup>2</sup> flexible leads
Control wires	NYM 3x1.5 mm <sup>2</sup> / H03VV-F2x0.75 mm <sup>2</sup>	0.5 mm <sup>2</sup> - 1.5 mm <sup>2</sup> massive leads 0.5 mm <sup>2</sup> - 1 mm <sup>2</sup> flexible leads
Sek. LED-Modulleitung	NYM 3x1.5 mm <sup>2</sup> / H03VV-F2x0.75 mm <sup>2</sup>	0.5 mm <sup>2</sup> - 1.5 mm <sup>2</sup> massive leads 0.5 mm <sup>2</sup> - 1 mm <sup>2</sup> flexible leads
Length of secondary cables	Depending on OPTOTRONIC® power supply	
Dimensions (l x b x h)	172 mm x 42 mm x 20 mm	80 mm x 40 mm x 22 mm
Approvals	 cURus	

Reference	Constant voltage	Constant voltage	Constant voltage
	OT RGB Sequencer	OT RGB 3-Channel DIM	OT DALI 25/220-240/24RGB
LED-modules	With respect to the output parameters: LINEARlight Colormix, LINEARlight, LINEARlight Flex, BACKlight, COINlight, MARKERlight, EFFECTlight and equivalent modules		With respect to the output parameters: LINEARlight Flex, MARKERlight, COINlight, LINEARlight colormix and equivalent modules
Nominal voltage	10.5 - 24 V <sub>DC</sub>	10.5 - 24 V <sub>DC</sub>	220-240 V
Input voltage range	9.5 - 25 V <sub>DC</sub>	9.5 - 25 V <sub>DC</sub>	198-254 V
Max. input current	6.0 A	6.0 A	
Control voltage	1...10 V <sub>DC</sub>	1...10 V <sub>DC</sub>	
Max. control current	0.6 mA	0.6 mA	
Control settings	< 1.3 V: all 3 channels off; 1.3 - 9.8 V: speed of sequence: 5 s - 10 min for one cycle of pre-set programme; >9.8 V: stop at the actual colour	1...10 V controllers, potentiometer 100 kW linear	DALI
Dimming mode	PWM	PWM	PWM
Operation frequency	350 Hz typ.	350 Hz typ.	1 kHz
Dimming range		0 - 100 % per channel	0 - 100 % per channel
Max. output current	2 A per channel	2 A per channel	
Output wattage range	0 - 21 W per channel at 10.5 V <sub>DC</sub>		
0 - 48 W per channel at 24 V <sub>DC</sub>	0 - 21 W per channel at 10.5 V <sub>DC</sub>		
0 - 48 W per channel at 24 V <sub>DC</sub>	Total of all 3 channels		
0 - 25 W			
Nominal current			0,13 A <sub>eff</sub>
Mains frequency			0/50/60 Hz
Nominal output voltage			24 V <sub>DC</sub>
Efficiency			82 %
Losses	< 4 W	< 4 W	Max. 3 W
DC voltage operation			Yes, 200 - 240 V <sub>DC</sub>
Safety	IEC 61347-2-2, IEC 61347-2-13		
Radio interference	EN 55015		
Harmonic content	EN 61000-3-2		
Immunity	EN 61547		
Protection class with regard to insulation			
Temperature range	-20 °C - +50 °C	-20 °C - +50 °C	-20 °C - +45 °C
Galvanic insulation between primary and secondary side			4 kV <sub>eff</sub> (SELV)
Open circuit test	Yes		
Short circuit protection	Automatic shut-down, independently reversible per channel		
Overload protection	Automatic shut-down, independently reversible per channel		
Overheating protection	Yes, automatic shut-down, reversible	Yes, automatic shut-down, reversible	Yes, automatic shut-down, reversible
Primary cables			One pair of cable clamp for mains and DALI
Wire cross section, control/primary side	0.75 mm <sup>2</sup> - 1.5 mm <sup>2</sup>	0.75 mm <sup>2</sup>	0.5 mm <sup>2</sup> - 1.5 mm <sup>2</sup> massive leads 0.5 mm <sup>2</sup> - 1 mm <sup>2</sup> flexible leads
Wire cross section, output/secondary side	0.75 mm <sup>2</sup> - 1.5 mm <sup>2</sup>	0.75 mm <sup>2</sup> - 1.5 mm <sup>2</sup>	0.5 mm <sup>2</sup> - 1.5 mm <sup>2</sup> massive leads 0.5 mm <sup>2</sup> - 1 mm <sup>2</sup> flexible leads
Max. length of secondary cables	Depends on type of OPTOTRONIC® power supply	Depends on type of OPTOTRONIC® power supply	10 m
Dimensions (l x b x h)	172 mm x 42 mm x 20 mm	172 mm x 42 mm x 20 mm	167 mm x 42 mm x 31 mm
Fixing screws	Ø 3mm or Ø 3.5mm	Ø 3mm or Ø 3.5mm	
Approvals	 cURus	 cURus	

## 7.5 Index

<b>1</b>	
1...10 V control output, maximum load	54
1...10 V control wires	53
1...10 V interface	
analogue output	57
features	51
installation instructions	52
U <sub>c</sub> -characteristic curve	31
<b>A</b>	
abbreviations	75
analogue output	
wiring	57
automatic circuit breaker	
maximum permissible number of power supplies	23
automatic circuit breakers	23
<b>B</b>	
bus system	69
<b>C</b>	
cable routing	71
cables	70
stripping length	70
colour-mix	35
control voltage	38
combination LED-modules with power supplies	24
control unit	
losses	47
control units	
selection for RGB system	46
types	24
control voltage for colour-mix	38
<b>D</b>	
DALI CON	62
DALI EASY	61
description	61
DALI interface	58
DALI-interface	
DALI CON	62
DALI EASY	61
DIM	
losses	44
DIM MCU	
technical data	55
wiring	54
DIM SA	57

dimensioning	
OT 9 DIM	31
OT DALI	42
OT DIM	32
RGB-system	43
dimming	
single-colour LED-modules	31
DMX-Gateways	63
DMX-interface	63
<b>E</b>	
electromagnetic compatibility	20
examples of applications	72
<b>I</b>	
immunity	21
installation instructions	64
IP types of protection	76
IP-protection class	24
<b>L</b>	
LED	
basic principle	3
LED-module	
selection for RGB system	45
total wattage	46
LED-modules	
combination with power supplies	24
dimming	31
types	8
life	15
light management system	51
LINEARlight Colormix	35
losses	47
OT DIM	47
OT RGB 3-channel DIM	48
low voltage cables	
extension through bus system	69
length for individual types	66
max. length	65
radio interference filter	65
<b>N</b>	
noise emission	21
<b>O</b>	
OT 9 DIM	
description	29
dimensioning	32
system wiring	33

OT DALI	
dimensioning	43
example of variable colour sequences	42
OT DALI RGB	
description	28
example colour sequences	40
OT DIM	
dimensioning	32
example colour-mix	35
system wiring	33
OT RGB 3-channel DIM	
example colour-mix	37
losses	48
OT RGB 3-Channel DIM	
description	28
OT RGB sequencer	
description	28
example colour-mix	37
example running light	39
outdoor application	24
overload behaviour	17
overload protection	19
<b>P</b>	
parallel connection	22
potentiometer	
1...10 V-interface	52
wiring	53
power range	
< 25 W	16
power supplies	
combination with LED-modules	24
DC voltage operation	15
design	18
electrical data	14
electromagnetic compatibility	20
immunity	21
installation instructions	64
noise emission	21
outdoor application	24
overload protection	19
permitted mains voltage	14
product overview	6
selection for RGB system	46
series and parallel connection	22
short circuit	19
starting current	23
technical data	77
temperature range	15
thermal management	23
power supplies advantages	12

power supplies constant current	
technical data	79
power supplies constant voltage	
technical data	77
power supplies constant-voltage	
types	13
power supplies power range	16
power supply	
description	3
product description	74

## R

radio interference	
cable routing	71
radio interference filter	64
RGB system	
selection control unit	47
selection power supply	48
RGB-system	
dimensioning	43
selection of LED-modules	46
running lights	
example with OT RGB sequencer	38

## S

series connection	22
short circuit	19
signal amplifier	56
stand-alone sequencer	
factory configuration	42
stand-alone-sequencer	41
standards	74
starting current	23
stripping length	70
system wiring	
OT 9 DIM	33
OT DIM	32

## T

temperature range	15
temperature $t_c$ at the measuring point	23
thermal management	23
total wattage	46, 47
type field	
description	5, 74

## U

Uc-characteristic curve	31
-------------------------	----

## Head office Germany

OSRAM GmbH  
Hellabrunner Straße 1  
81543 München  
Tel.: +49-89-62 13-0  
Fax: +49-89-62 13-20 20

## International addresses

### Albania

(supported by OSRAM Greece)

### Argentina

OSRAM Argentina S.A.C.I.  
Ramos Mejia 2456  
B 1643 ADN Beccar  
Pcia. De Buenos Aires  
Tel.: +54-11-6333-8000  
Fax: +54-11-6333-8001

### Australia

OSRAM Australia Pty. Ltd. Sydney  
11th Floor, Building 1  
423 Pennant Hills Road  
2120 Pennant Hills, N.S.W.  
P.O. Box 673  
1715 Pennant Hills  
Tel.: +61-29-4 81-83 99  
Fax: +61-29-4 81-91 27

### Austria

OSRAM GmbH  
Lemböckgasse 49/C/5  
1230 Wien  
Postfach 1 62  
1231 Wien  
Tel.: +43-1-6 80 68-0  
Fax: +43-1-6 80 68 -7

### Azores

(supported by OSRAM Portugal)

### Benelux

OSRAM Benelux B.V.  
Klaverbaan 102  
2908 KD Capelle a/d IJssel  
Netherlands  
Tel.: NL +31-10-750 14 14  
BE +32-78-55 08 20  
Fax: NL +31-10-750 14 06  
BE +32-78-55 08 28

### Bosnia-Herzegovina

(supported by OSRAM Croatia)

### Brazil

OSRAM do Brasil Lâmpadas Elétricas Ltda.  
Av. Dos Autonomistas, 4229  
06090-901 Osasco-SP/Brazil  
Tel.: +55-11-36 84 74 08  
Fax: +55-11-36 85 94 95

### Bulgaria

OSRAM EOOD  
Nikola Obreschkov 1  
Wh. A., App. 1  
1113 Sofia  
Tel.: +359-2-9 71 22 62  
Fax: +359-2-9 71 45 46

### Canada

OSRAM SYLVANIA Ltd./Lte.  
2001 Drew Road  
Mississauga  
Ontario L5S 1S4  
Tel.: +1-905-6 73 61 71  
Fax: +1-905-6 71 55 84

### Chile

OSRAM Chile Ltda.  
OSRAM Chile Ltda.  
Av. Los Leones 382 oficina 101  
Providencia  
Santiago de Chile  
Tel.: +56-2-333 4331  
Fax: +56-2-333 4363

### China

OSRAM China Lighting Ltd.  
No.1North Industrial Road,  
Postal Code 528000  
Foshan, Guangdong  
Tel.: +86-757-864 82-111  
Fax: +86-757-864 82-222  
OSRAM Shanghai Rep. Office  
Harbour Ring Plaza  
No. 18 Xi Zang Middle Road  
Room 2802, 2803 A  
Shanghai, 200001 P.R.C.  
Tel.: +86-21-53 85 28 (48)  
Fax: +86-21-64 82 12 19

### Colombia

OSRAM de Colombia  
Diagonal 109 No. 21-05  
Oficina 607, 608  
Bogotá  
Tel.: +57-1-6 19 24 07  
Fax: +57-1-6 37 18 55

### Croatia

OSRAM d.o.o.  
Majstora Radonje 10  
10000 Zagreb  
Tel.: +385-1-303-20 00  
Fax: +385-1-303-20 01

### Czechia

OSRAM spol. s.r.o.  
Kodanská 1441/46  
100 10 Praha 10  
Tel.: +420-234 06 60 00  
Fax: +420-234 06 60 20

### Denmark

OSRAM A/S  
Dybendalsvænget 3  
2630 Tåstrup  
Postboks 259  
2630 Tåstrup  
Tel.: +45-44-77 50-00  
Fax: +45-44-77 50-55

### Egypt

OSRAM Rep. Office Cairo  
5th Floor, Unit No. 507  
57 Giza Street  
Cairo, Giza  
Tel.: +20-2-7 61 19 76  
Fax: +20-2-7 48 66 46

### Ecuador

OSRAM del Ecuador S.A.  
Casilla 09-01-8410  
Guayaquil  
Tel.: +593-4-2 89 36 09  
Fax: +593-4-2 89 35 58

### Estonia

(supported by OSRAM Finland)

### Finland

Oy OSRAM AB, Helsinki  
Vanha Porvoontie 229  
01380 Vantaa  
Box 91  
01301 Vantaa  
Tel.: +358-9-74 22 33 00  
Fax: +358-9-74 22 33 74

### France

OSRAM SASU  
5, Rue d'Altorf  
67129 Molsheim Cedex  
Tel.: +33-388-49 75 99  
Fax: +33-388-49 75 975

### Great Britain

OSRAM Ltd., London  
OSRAM House  
Waterside Drive  
Langley, Berkshire  
SL3 6EZ  
Tel.: +44-17 53 48 4 (100)  
Fax: +44-17 53 48 42 22

### Greece

OSRAM A.E.  
Frantzi 6 & Ag. Pavlou  
12132 Peristeri  
Tel.: +30-210-5 20 18 00  
Fax: +30-210-5 22 72 00

### Hong Kong

OSRAM Prosperity Co. Ltd.  
Rm 4007-09 Office Tower  
Convention Plaza  
1 Harbour Road, Wanchai  
Tel.: +852-25 11 22 68  
Fax: +852-25 11 20 38

### Hungary

OSRAM KFT.  
Alkotás utca 41.  
1123 Budapest  
Tel.: +36-1-2 25-30 55  
Fax: +36-1-2 25-30 54

### India

OSRAM India Private Ltd.  
Signature Towers, 11th Floor,  
Tower-B South City-I  
122001 Gurgaon Haryana/India  
Tel.: +91-124-238 31-80  
Fax: +91-124-238 31-82

### Indonesia

PT. OSRAM Indonesia  
Jalan Siliwangi KM 1  
Desa Keroncong  
Jatiuwung  
15134 Tangerang  
Tel.: +62-21-5 90 01 27  
Fax: +62-21-5 90 05 59

### Iran

OSRAM Lamps P.J.S Co.  
Bokharest Ave, Str. 6, No. 13  
Tehran  
Tel.: +98-21-88 73 84 76  
Fax: +98-21-88 73 24 13

### Italy

OSRAM Società Riunite  
OSRAM Edison-Clerici Spa  
Via Savona 105  
20144 Milano  
Tel.: +39-02-42 49-1  
Fax: +39-02-42 49-380

### Japan

OSRAM MELCO Ltd.  
Tobu Yokohama Bldg.No. 3 (4F)  
8-29 Kita-Saiwai 2-chome, Nishi-Ku  
220-0004 Yokohama  
Tel.: +81-45-3 23 51-29-0  
Fax: +81-45-3 23 51-55

### OSRAM Ltd.

Tobu Yokohama Bldg.No. 3 (6F)  
8-29 Kita-Saiwai 2-chome, Nishi-Ku  
220-0004 Yokohama  
Tel.: +81-45-3 23 51-00  
Fax: +81-45-3 23 51-10

### Kenya

OSRAM East Africa  
Post Box 10755-00100  
Longonot place, office No. 9, 4th floor  
Kijabe street  
Nairobi, Kenya  
Tel.: +254-20 31 32 45  
Fax: +254-20 31 90 42

### Korea

OSRAM Korea Co. Ltd.  
3rd. Fl. Ye-Sung Bldg.  
150-30 Samsung-dong, Kangnam-Ku  
Seoul 135-090  
Tel.: +82-2-5 54 41 12  
Fax: +82-2-5 56 16 44

### Latvia

(supported by OSRAM Finland)

### Lithuania

(supported by OSRAM Finland)

### Macedonia

(supported by OSRAM Greece)

### Madeira

(supported by OSRAM Portugal)

### Malaysia

OSRAM Sdn Bhd  
7.05-7.06 Amoda Building  
22 Jalan Imbi  
55100 Kuala Lumpur  
Tel.: +60-3-21 45 95-33  
Fax: +60-3-21 45 95-35

### Mexico

OSRAM de México, S.A. de C.V.  
Camino a Tepalcapa No. 8  
Col. San Martín  
54900 Tultitlán  
Edo. de México  
Tel.: +52-55-58 99-18 00  
Fax: +52-55-58 84-70 00

### Norway

OSRAM AS  
Strandveien 50  
1366 Lysaker  
Tel.: +47-40 00 41 10  
Fax: +47-67 53 61 79

### Philippines

OSRAM Philippines Ltd. Corp.  
Unit 2002-2003  
Antel Global Corporate Center  
Julia Vargas Avenue  
Ortigas Center  
Pasig City  
Tel.: +632-687 60 48-50  
Fax: +632-687 60 57

### Poland

OSRAM sp. z o.o.  
ul. Wierznicza 117  
02-952 Warszawa  
Tel.: +48-22-550 23 00  
Fax: +48-22-550 23 19

### Portugal

OSRAM Empresa de  
Aparelhagem Eléctrica Lda.  
Rua do Alto do Montijo  
Nr. 15-4 andar  
2794-069 Carnaxide  
Tel.: +351-2 14 16 58 60  
Fax: +351-2 14 17 12 59

### Romania

OSRAM Romania S.R.L.  
Calea Plevnei nr. 139  
corp B, sector 6  
060011 Bucaresti  
Tel.: +40-21-2077-386  
Fax: +40-21-2077-389

### Russia

OSRAM Moscow  
Ul. Malaja Kaluschskaja 15/4  
119071 Moscow  
Tel.: +7-495-9 35 70-70  
Fax: +7-495-9 35 70-76

### Serbia and Montenegro

OSRAM d.o.o., Beograd  
Cika Ljubina 15/V  
YU-11000 Beograd  
Tel.: +381 (0)11-30 30-860  
Fax: +381 (0)11-30 30-853

### Singapore

OSRAM Pte. Ltd.  
159 Sin Ming Road  
#05-04 Amtech Building  
575625 Singapore  
Tel.: +65-65 52 01 10  
Fax: +65-65 52 71 17

### Slovakia

OSRAM Nové Zámky  
Komárnanská cesta 7  
94093 Nové Zámky  
Tel.: +42-1-35 64 64-0  
Fax: +42-1-35 64 64-880

### Slovenia

(supported by OSRAM Austria)

### South Africa

OSRAM (Pty.) Ltd.,  
260, 15th Road  
1683 Randjespark/Midrand  
Private BAG X 206  
1685 Halfway House/Midrand  
Tel.: +27-11-2 07 56 00  
Fax: +27-11-8 05 17 11

### Spain

OSRAM, S.A.  
Calle de la Solana, 47  
28850 Torrejón de Ardoz (Madrid)  
Tel.: +34-91-6 55 52 00  
Fax: +34-91-6 56 82 16

### Sweden

OSRAM AB  
Rudanvägen 1  
13625 Haninge  
Box 5 04  
13650 Haninge  
Tel.: +46-8-7 07 44-00  
Fax: +46-8-7 07 44-40

### Switzerland

OSRAM AG, Winterthur  
In der Au 6  
8401 Winterthur/Töss  
Postfach 2179  
8401 Winterthur/Töss  
Tel.: +41-52-2 09 91 91  
Fax: +41-52-2 09 92 75

### Taiwan

OSRAM Taiwan Company Ltd.  
Sung Chiang Road, 7th Floor, No. 87  
Sung Chiang Road  
P.O. Box 46304  
Taipei - Taiwan, R.O.C.  
Tel.: +886-2-25 08 35 02  
Fax: +886-2-25 09 67 82

### Thailand

OSRAM Thailand Co. Ltd.  
100/45, 24th Floor  
Sathorn Nakorn Tower  
North Sathorn Road  
Khwaeng Silom  
Khet Bangrak, Bangkok 10500  
Tel.: +66-2-6 36 74 75  
Fax: +66-2-6 36 74 77

### Turkey

OSRAM AMPUL TIC. A.S.  
Meclisi Mebusan Caddesi 125  
80400 Findikli, Istanbul/TR  
Tel.: +90-212-334-1334  
Fax: +90-212-334-1142

### Ukraine

OSRAM Ukraine  
Podil Plasa Business Center  
30-A Spaska Str., office 2-3B  
Kiev 04070  
Tel.: +38-044-467 66 67  
Fax: +38-044-467 69 58

### United Arab Emirates

OSRAM Middle East FZE  
P.O. Box 17476  
Room #602-603, LOB #16  
Jebel Ali Free Zone  
Dubai United Arab Emirates  
Tel.: +971-4-88 13-767  
Fax: +971-4-88 13-769

### USA

OSRAM SYLVANIA INC.  
100 Endicott Street  
Danvers, MA 01923  
Tel.: +1-978-777-19 00  
Fax: +1-978-750-21 52

### Vietnam

OSRAM Singapore Pte. Ltd.  
Rep. Office Vietnam  
59A Ly Thai To Street,  
Hanoi Press Club  
Hoan Kiem District  
Hanoi  
Tel.: +84-4-93 49-801  
Fax: +84-4-93 49-803

### Internet

<http://www.osram.de>  
<http://www.osram.com>  
<http://catalog.myosram.com/DE>  
<http://catalog.myosram.com/EN>