

Optocoupler, Photodarlington Output, High Gain, with Base Connection

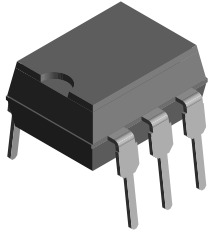

1179005

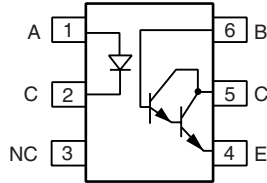

FEATURES

- Isolation test voltage, 5300 V_{RMS}
- Coupling capacitance, 0.5 pF
- Fast rise time, 10 μs
- Fast fall time, 35 μs
- Lead (Pb)-free component
- Component in accordance to RoHS 2002/95/EC and WEEE 2002/96/EC



RoHS
COMPLIANT

DESCRIPTION

The MCA230/MCA231/MCA255 are industry standard optocouplers, consisting of a gallium arsenide infrared LED and a silicon photodarlington. These optocouplers are constructed with a high voltage insulation packaging process which offers 7.5 kV withstand test capability.

AGENCY APPROVALS

- UL1577, file no. E52744 system code H or J, double protection
- DIN EN 60747-5-2 (VDE 0884)/DIN EN 60747-5-5 pending available with option 1
- CSA 93751
- BSI IEC 60950; IEC 60065

ORDER INFORMATION	
PART	REMARKS
MCA230	CTR > 100 %, DIP-6
MCA231	CTR > 200 %, DIP-6
MCA255	CTR > 100 %, DIP-6
MCA231-X009	CTR > 200 %, SMD-6 (option 9)

Note

For additional information on the available options refer to option information.

ABSOLUTE MAXIMUM RATINGS					
PARAMETER	TEST CONDITION	PART	SYMBOL	VALUE	UNIT
INPUT					
Reverse voltage			V _R	6.0	V
Forward continuous current			I _F	60	mA
Power dissipation			P _{diss}	135	mW
Derate linearly from 25°C				1.8	mW/°C
OUTPUT					
Collector emitter breakdown voltage		MCA230	BV _{CEO}	30	V
		MCA231	BV _{CEO}	30	V
		MCA255	BV _{CEO}	55	V
Emitter collector breakdown voltage			BV _{ECO}	7.0	V
Collector base breakdown voltage		MCA230	BV _{CBO}	30	V
		MCA231	BV _{CBO}	30	V
		MCA255	BV _{CBO}	55	V
Power dissipation			P _{diss}	210	mW
Derate linearly from 25°C				2.8	mW/°C

MCA230/MCA231/MCA255



Vishay Semiconductors Optocoupler, Photodarlington Output,
High Gain,
with Base Connection

ABSOLUTE MAXIMUM RATINGS					
PARAMETER	TEST CONDITION	PART	SYMBOL	VALUE	UNIT
COUPLER					
Total package dissipation (LED plus detector)			P_{tot}	260	mW
Derate linearly from 25 °C				3.5	mW/°C
Storage temperature			T_{stg}	- 55 to + 150	°C
Operating temperature			T_{amb}	- 55 to + 100	°C
Lead soldering time at 260 °C				10	s
Isolation test voltage			V_{ISO}	5300	V_{RMS}
Isolation resistance	$V_{IO} = 500\text{ V}, T_{amb} = 25\text{ °C}$		R_{IO}	10^{12}	Ω
	$V_{IO} = 500\text{ V}, T_{amb} = 100\text{ °C}$		R_{IO}	10^{11}	Ω

Note

$T_{amb} = 25\text{ °C}$, unless otherwise specified.

Stresses in excess of the absolute maximum ratings can cause permanent damage to the device. Functional operation of the device is not implied at these or any other conditions in excess of those given in the operational sections of this document. Exposure to absolute maximum ratings for extended periods of the time can adversely affect reliability.

ELECTRICAL CHARACTERISTICS							
PARAMETER	TEST CONDITION	PART	SYMBOL	MIN.	TYP.	MAX.	UNIT
INPUT							
Forward voltage	$I_F = 50\text{ mA}$		V_F		1.1	1.5	V
Reverse current	$V_R = 3.0\text{ V}$		I_R			10	μA
Junction capacitance	$V_R = 3.0\text{ V}$		C_j		50		pF
OUTPUT							
Collector emitter breakdown voltage	$I_C = 100\text{ }\mu\text{A}, I_F = 0\text{ mA}$	MCA230	BV_{CEO}	30			V
		MCA231	BV_{CEO}	30			V
		MCA255	BV_{CEO}	30			V
Emitter collector breakdown voltage	$I_E = 10\text{ }\mu\text{A}, I_F = 0\text{ mA}$		BV_{ECO}	7.0			V
Collector base breakdown voltage	$I_C = 10\text{ }\mu\text{A}, I_F = 0\text{ mA}$	MCA230	BV_{CBO}	30			V
		MCA231	BV_{CBO}	30			V
		MCA255	BV_{CBO}	55			V
Collector emitter leakage current			I_{CEO}			100	nA
COUPLER							
Collector emitter saturation voltage	$I_C = 2.0\text{ mA}, I_F = 16\text{ mA}$		V_{CEsat}			0.8	V
	$I_C = I_F = 50\text{ mA}$		V_{CEsat}			1.0	V
	$I_C = 2.0\text{ mA}, I_F = 1.0\text{ mA}$		V_{CEsat}			1.0	V
	$I_C = 10\text{ mA}, I_F = 5.0\text{ mA}$		V_{CEsat}			1.0	V
	$I_C = 50\text{ mA}, I_F = 10\text{ mA}$		V_{CEsat}			1.2	V
Capacitance (input to output)			C_{IO}		0.5		pF

Note

$T_{amb} = 25\text{ °C}$, unless otherwise specified.

Minimum and maximum values are testing requirements. Typical values are characteristics of the device and are the result of engineering evaluation. Typical values are for information only and are not part of the testing requirements.

CURRENT TRANSFER RATIO						
PARAMETER	TEST CONDITION	SYMBOL	MIN.	TYP.	MAX.	UNIT
DC current transfer ratio	$V_{CE} = 5.0\text{ V}, I_F = 10\text{ mA}$	CTR_{DC}	100			%
	$V_{CE} = 5.0\text{ V}, I_F = 1.0\text{ mA}$	CTR_{DC}	200			%

SWITCHING CHARACTERISTICS						
PARAMETER	TEST CONDITION	SYMBOL	MIN.	TYP.	MAX.	UNIT
Switching times	$R_L = 100\text{ }\Omega, V_{CE} = 10\text{ V}$	t_{on}		10		μs
		t_{off}		30		μs



Optocoupler, Photodarlington Output, Vishay Semiconductors
High Gain,
with Base Connection

TYPICAL CHARACTERISTICS

$T_{amb} = 25\text{ }^{\circ}\text{C}$ unless otherwise specified

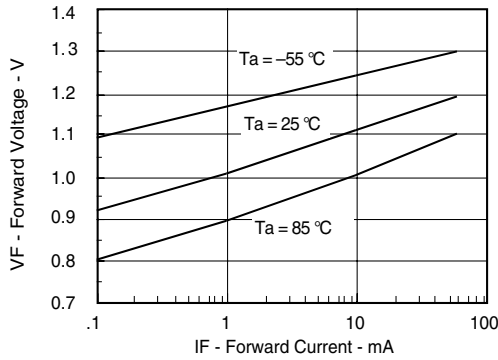

imca230_01

Fig. 1 - Forward Voltage vs. Forward Current

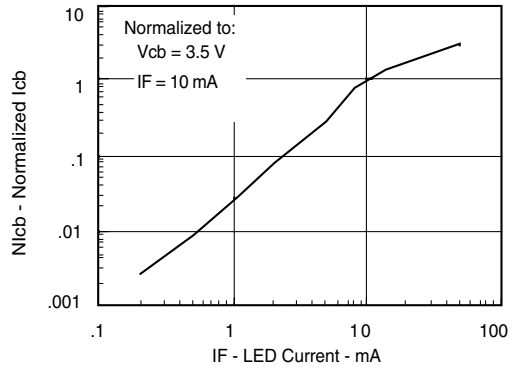

imca230_04

Fig. 4 - Normalized Collector Base Photocurrent vs. LED Current

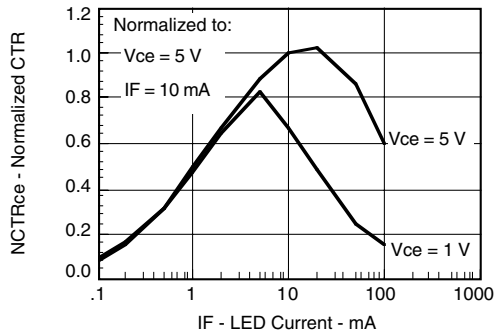

imca230_02

Fig. 2 - Normalized Non-Saturated and Saturated CTR vs. LED Current

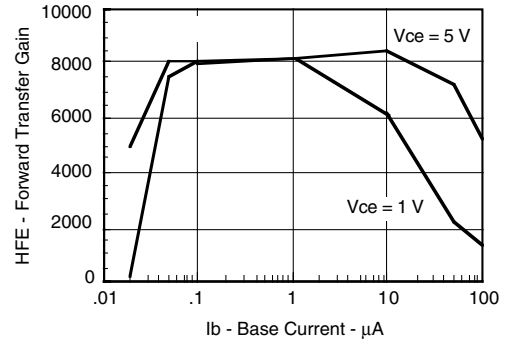

imca230_05

Fig. 5 - Non Saturated and Saturated HFE vs. Base Current

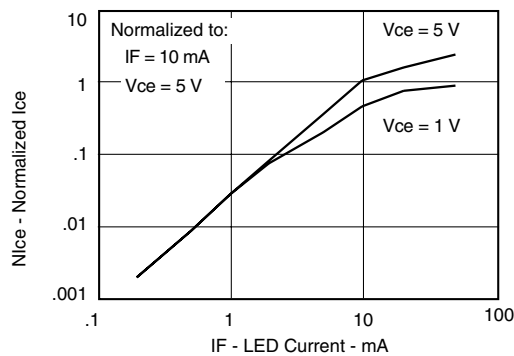

imca230_03

Fig. 3 - Normalized Non-Saturated and Saturated Collector Emitter Current vs. LED Current

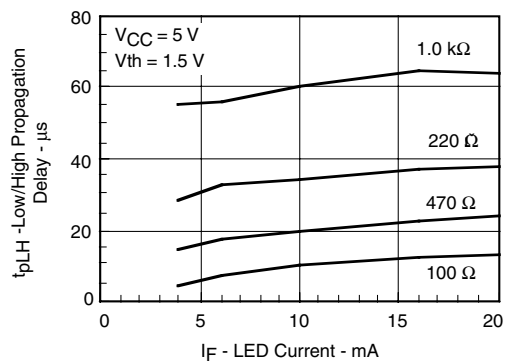

imca230_06

Fig. 6 - Low to High Propagation Delay vs. Collector Load Resistance and LED Current

MCA230/MCA231/MCA255



Vishay Semiconductors Optocoupler, Photodarlington Output,
High Gain,
with Base Connection

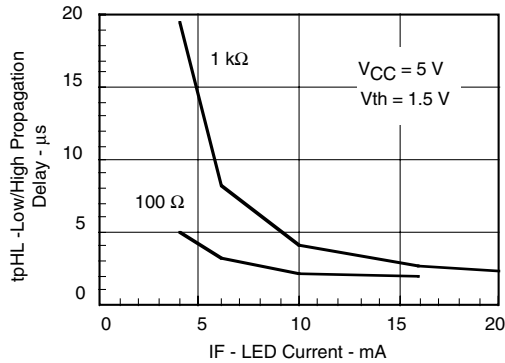

Fig. 7 - High to low Propagation Delay vs. Collector Load Resistance and LED Current

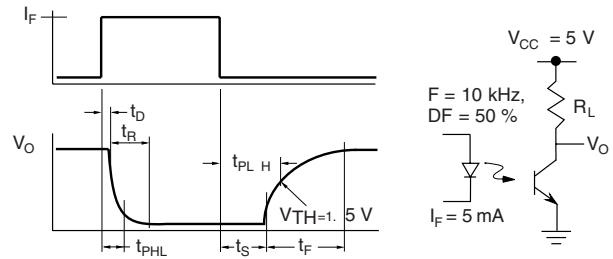
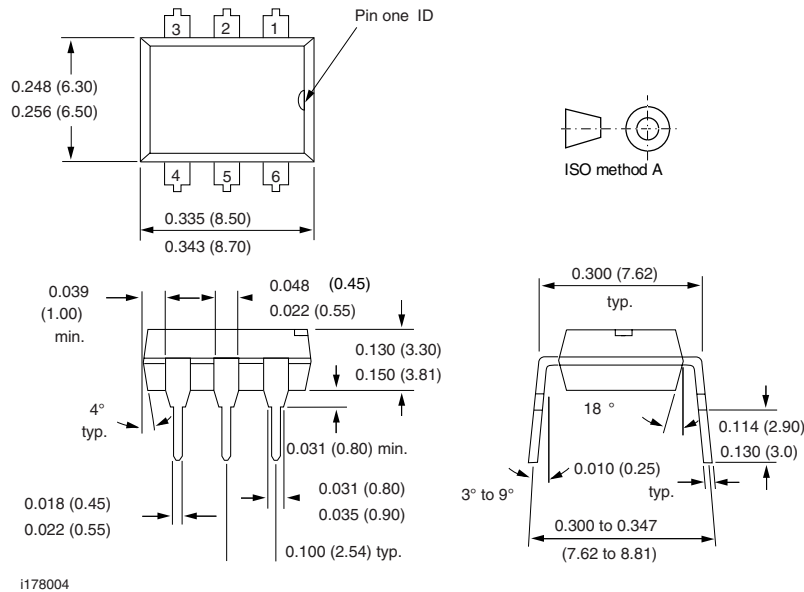
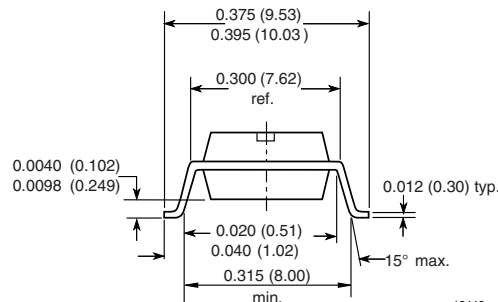

Fig. 8 - Switching Timing Waveform and Schematic

PACKAGE DIMENSIONS in inches (millimeters)



Option 9





Optocoupler, Photodarlington Output, Vishay Semiconductors
High Gain,
with Base Connection

OZONE DEPLETING SUBSTANCES POLICY STATEMENT

It is the policy of Vishay Semiconductor GmbH to

1. Meet all present and future national and international statutory requirements.
2. Regularly and continuously improve the performance of our products, processes, distribution and operating systems with respect to their impact on the health and safety of our employees and the public, as well as their impact on the environment.

It is particular concern to control or eliminate releases of those substances into the atmosphere which are known as ozone depleting substances (ODSs).

The Montreal Protocol (1987) and its London Amendments (1990) intend to severely restrict the use of ODSs and forbid their use within the next ten years. Various national and international initiatives are pressing for an earlier ban on these substances.

Vishay Semiconductor GmbH has been able to use its policy of continuous improvements to eliminate the use of ODSs listed in the following documents.

1. Annex A, B and list of transitional substances of the Montreal Protocol and the London Amendments respectively.
2. Class I and II ozone depleting substances in the Clean Air Act Amendments of 1990 by the Environmental Protection Agency (EPA) in the USA.
3. Council Decision 88/540/EEC and 91/690/EEC Annex A, B and C (transitional substances) respectively.

Vishay Semiconductor GmbH can certify that our semiconductors are not manufactured with ozone depleting substances and do not contain such substances.

We reserve the right to make changes to improve technical design
and may do so without further notice.

Parameters can vary in different applications. All operating parameters must be validated for each customer application by the customer. Should the buyer use Vishay Semiconductors products for any unintended or unauthorized application, the buyer shall indemnify Vishay Semiconductors against all claims, costs, damages, and expenses, arising out of, directly or indirectly, any claim of personal damage, injury or death associated with such unintended or unauthorized use.

Vishay Semiconductor GmbH, P.O.B. 3535, D-74025 Heilbronn, Germany



Disclaimer

All product specifications and data are subject to change without notice.

Vishay Intertechnology, Inc., its affiliates, agents, and employees, and all persons acting on its or their behalf (collectively, "Vishay"), disclaim any and all liability for any errors, inaccuracies or incompleteness contained herein or in any other disclosure relating to any product.

Vishay disclaims any and all liability arising out of the use or application of any product described herein or of any information provided herein to the maximum extent permitted by law. The product specifications do not expand or otherwise modify Vishay's terms and conditions of purchase, including but not limited to the warranty expressed therein, which apply to these products.

No license, express or implied, by estoppel or otherwise, to any intellectual property rights is granted by this document or by any conduct of Vishay.

The products shown herein are not designed for use in medical, life-saving, or life-sustaining applications unless otherwise expressly indicated. Customers using or selling Vishay products not expressly indicated for use in such applications do so entirely at their own risk and agree to fully indemnify Vishay for any damages arising or resulting from such use or sale. Please contact authorized Vishay personnel to obtain written terms and conditions regarding products designed for such applications.

Product names and markings noted herein may be trademarks of their respective owners.