

# Chip Beads(SMD Array) For Audio / USB1.1 Signal Line

Conformity to RoHS Directive

## MCZ Series MCZ1210-D Type(2-Line)

This is a common type bead product that removes the noise components in a signal line and includes beads for two lines in a single chip. The product exhibits substantial impedance characteristics in the high frequency range and is therefore capable of effectively removing differential mode noises. Additionally, an appropriate amount of magnetic coupling is created between the beads of the two lines, giving the product the capability to remove not only differential mode noise but common mode noise as well. It is encased in a 1210 casing. This is an SMD product that allows for automatic mounting by taping.

### FEATURES

- Compact size, Low Rdc (0.75Ω max.)
- Capable of removing both common and differential mode noises.
- Closed magnetic circuit structure allows high-density installation while preventing crosstalk between circuits.

### APPLICATIONS

Removal of audio signal line noises of cellular phones, PCs, note PCs, DSCs, portable game machines, etc.

### PRODUCT IDENTIFICATION

MCZ	1210	A	D	102	T
(1)	(2)	(3)	(4)	(5)	(6)

- (1) Series name
- (2) Dimensions L×W
- (3) Ferrite material
- (4) Number of line
- (5) Impedance  
102:1000Ω at 100MHz
- (6) Packaging style  
T:Taping

### SHAPES AND DIMENSIONS/RECOMMENDED PC BOARD PATTERN

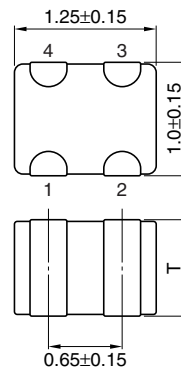

T	Weight
0.5±0.10mm	3mg
0.85±0.15mm	4mg

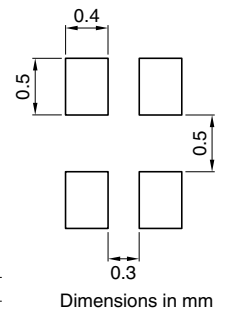

### CIRCUIT DIAGRAM

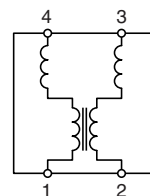

- No polarity



### TEMPERATURE RANGES

Operating/Storage	-40 to +85°C
-------------------	--------------

### PACKAGING STYLE AND QUANTITIES

Packaging style	Quantity
Taping	4000 pieces/reel

### HANDLING AND PRECAUTIONS

- Before soldering, be sure to preheat components. The preheating temperature should be set so that the temperature difference between the solder temperature and product temperature does not exceed 150°C.
- After mounting components onto the printed circuit board, do not apply stress through board bending or mishandling.
- Do not expose the inductors to stray magnetic fields.
- Avoid static electricity discharge during handling.
- When hand soldering, apply the soldering iron to the printed circuit board only. Temperature of the iron tip should not exceed 350°C. Soldering time should not exceed 3 seconds.
- This product does not apply to flow soldering construction method.

- Conformity to RoHS Directive: This means that, in conformity with EU Directive 2002/95/EC, lead, cadmium, mercury, hexavalent chromium, and specific bromine-based flame retardants, PBB and PBDE, have not been used, except for exempted applications.
- Please contact our Sales office when your application are considered the following:  
The device's failure or malfunction may directly endanger human life (e.g. application for automobile/aircraft/medical/nuclear power devices, etc.)

• All specifications are subject to change without notice.

## ELECTRICAL CHARACTERISTICS

Part No.	Open mode impedance ( $\Omega$ )[at 100MHz]*	DC resistance ( $\Omega$ )max.	Insulation resistance (M $\Omega$ )min.	Rated voltage Edc(V)max.	Rated current Idc(mA)max.	Thickness T (mm)
MCZ1210AD102T	1000 $\pm$ 25%	0.75	1	5	50	0.85
MCZ1210AD221T	220 $\pm$ 25%	0.3	1	5	350	0.85
MCZ1210AD121T002	120 $\pm$ 25%	0.2	1	5	500	0.5
MCZ1210AD900T002	90 $\pm$ 25%	0.2	1	5	500	0.5

\* Test equipment: E4991A or equivalent

Test tool: 16192A or equivalent

Test temperature: 25 $\pm$ 10°C

## TYPICAL ELECTRICAL CHARACTERISTICS

### IMPEDANCE vs. FREQUENCY CHARACTERISTICS

#### MCZ1210AD102

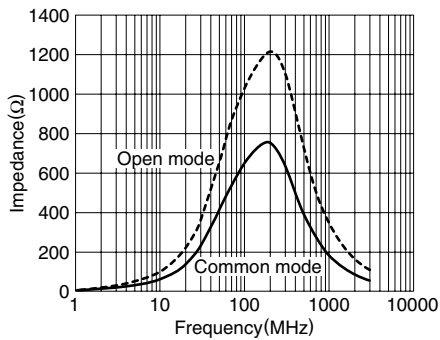

#### MCZ1210AD221

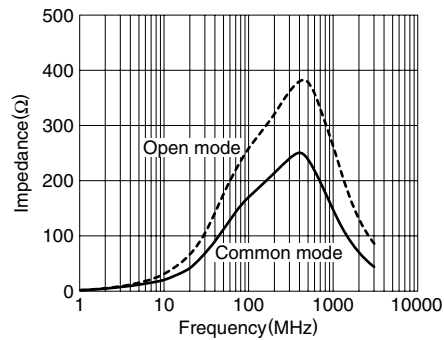

#### MCZ1210AD121T002

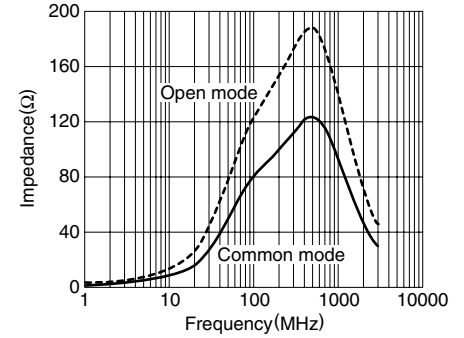

#### MCZ1210AD900T002

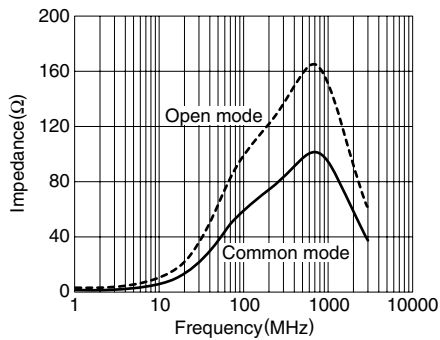

## MEASURING CIRCUITS

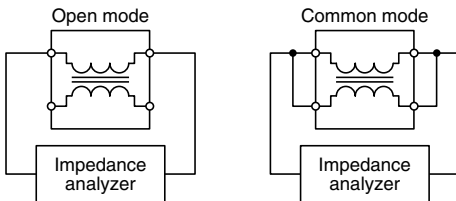

## PACKAGING STYLES

### REEL DIMENSIONS

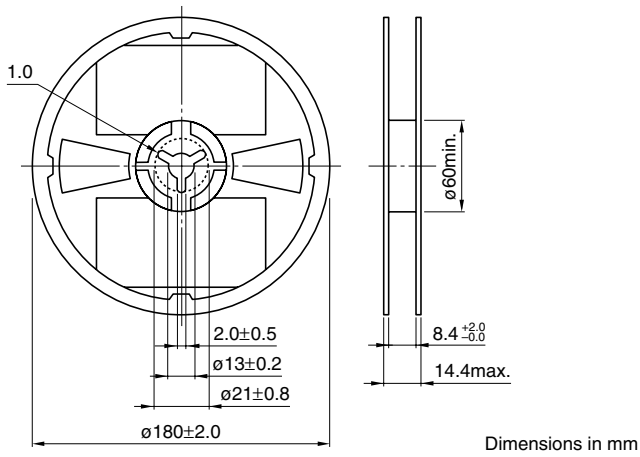

### TAPE DIMENSIONS

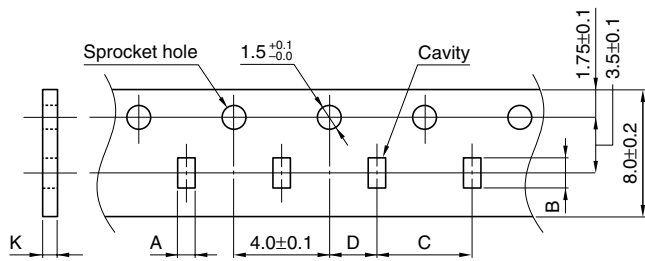

Thickness	A	B	C	D	K
0.85mm	$1.2 \pm 0.1$	$1.45 \pm 0.1$	$4.0 \pm 0.1$	$2.0 \pm 0.1$	$0.95 \pm 0.10$
0.50mm	$1.2 \pm 0.1$	$1.45 \pm 0.1$	$4.0 \pm 0.1$	$2.0 \pm 0.1$	$0.60 \pm 0.05$

