

NAIS

COMPACT POWER RELAYS

JC-RELAYS

FEATURES

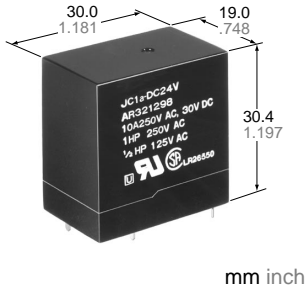

- **High inrush current capability**
1 Form A: 163 A inrush (TV-8)
2 Form A: 111 A inrush (TV-5)
- **High dielectric withstanding for transient protection:**
JC can withstand 10,000 V surge in μ s between coil and contact.
- **Electrical life:**
1 Form A: 10^5 ope. at 15 A 250 V AC resistive load
2 Form A: 10^5 ope. at 10 A 250 V AC resistive load
- **TÜV also approved**

SPECIFICATIONS

Contact

Arrangement		1 Form A	2 Form A	
Initial contact resistance, max. (By voltage drop 6 V DC 1 A)		30 m Ω (Cd free type: 100 m Ω)		
Contact material		Silver alloy		
Contact force, min.		30 g		
Rating (resistive load)	Maximum switching power	3,750 VA	2,500 VA	
	Maximum switching voltage	250 V AC	250 V AC	
	Max. switching current	15 A	10 A	
Expected life (min. operation)	Mechanical	5×10^6		
	Electrical (resistive)	10 A 250 V AC	10^5	—
		5A 250 V AC	—	10^5

Coil

Minimum operating power	576 mW	640 mW
Nominal operating power	900 mW	1,000 mW

Remarks

- * Specifications will vary with foreign standards certification ratings.
- *1 Measurement of same location as "Initial breakdown voltage" section
- *2 Detection current: 10mA
- *3 Excluding contact bounce time
- *4 Half-wave pulse of sine wave: 11ms; detection time: 10 μ s
- *5 Half-wave pulse of sine wave: 6ms
- *6 Detection time: 10 μ s
- *7 Refer to 5. Conditions for operation, transport and storage mentioned in AMBIENT ENVIRONMENT (Page 24).

Characteristics

Maximum operating speed	20 cpm.	
Initial insulation resistance*1	Min. 100 M Ω at 500 V DC	
Initial breakdown voltage*2	Between open contacts	2,000 V rms for 1 min. (N.C. contact of 1a1b: 1,000 Vrms)
	Between contacts sets	2,000 Vrms for 1 min.
	Between contacts and coil	4,000 Vrms for 1 min.
Operate time*3 (at nominal voltage)	Approx. 15 ms	
Release time(without diode)*3 (at nominal voltage)	Approx. 2 ms	
Temperature rise (at nominal voltage)	Max. 55°C	
Shock resistance	Functional*4	196 m/s ² {20 G}
	Destructive*5	980 m/s ² {100 G}
Vibration resistance	Functional*6	98 m/s ² {10 G}, 10 to 55 Hz at double amplitude of 1.6 mm [1a1b type at double amplitude: 1.0 mm, 58.8 m/s ² {6 G}]
	Destructive	117.6 m/s ² {12 G}, 10 to 55 Hz at double amplitude of 2 mm
Conditions for operation, transport and storage*7 (Not freezing and condensing at low temperature)	Ambient temp.	-50°C to +60°C -58°F to +140°F
	Humidity	5 to 85%R.H.
Unit weight	Approx. 31 g 1.09 oz	

TYPICAL APPLICATIONS ORDERING INFORMATION

Automatic garage door openers
Microwave ovens
Dryers
Vending machines
Copiers
Air conditioners
Stereo equipment
TV sets

Ex. JC 1a F — TM — DC12V

Contact arrangement	Mounting classification	Coil voltage
1a: 1 Form A 2a: 2 Form A	Nil: PC board terminal S: Plug-in terminal TM: Top mounting	DC 5, 6, 12, 24, 48 V

- (Notes) 1. TV rated types available 1 Form A: TV 8; 2 Form A: TV-5.
2. For UL/CSA recognized types, add suffix UL/CSA.
3. Standard packing Carton: 50 pcs.; Case: 200 pcs.
4. For Cd free contact material type, add suffix "-F".

ADDITIONAL SERIES

Following up-graded contact rating types recognized by UL and CSA are available.

Contact arrangement	Additional letter	F (JC1aF, JC2aF)
1 Form A		15 A 250 V AC, 1 HP 125 V AC 15 A 30 V DC, 1 HP 250 V AC
2 Form A		10 A 250 V AC, 1/3 HP 125 V AC 10 A 30 V DC, 1/2 HP 250 V AC

COIL DATA (at 20°C 68°F)

Contact arrangement	Nominal voltage, V DC	Pick-up voltage, V DC (max.)	Drop-out voltage, V DC (min.)	Coil resistance, Ω(±10%)	Nominal operating current, mA	Nominal operating power, W	Maximum allowable voltage, V DC (at 60°C)
1 Form A	6	4.8	0.6	40	150	0.9	6.6
	12	9.6	1.2	160	75	0.9	13.2
	24	19.2	2.4	640	37.5	0.9	26.4
	48	38.4	4.8	2,560	18.8	0.9	52.8
2 Form A	6	4.8	0.6	36	166.6	1.0	6.6
	12	9.6	1.2	144	83.3	1.0	13.2
	24	19.2	2.4	576	41.6	1.0	26.4
	48	38.4	4.8	2,304	20.8	1.0	52.8

Note: Coil resistance varies ±10% for less than 1,000 Ω and ±15% for more than 1,000 W.
For each ±1°C change in ambient temperature, coil resistance varies ±0.4%.

DIMENSIONS

mm inch

**PC board type
JC1a**

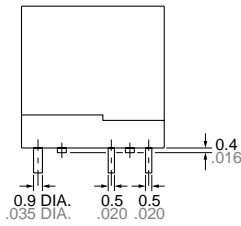
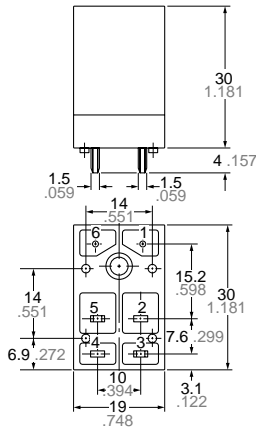

Schematic

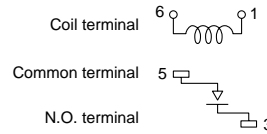

PC board pattern (Copper-side view)

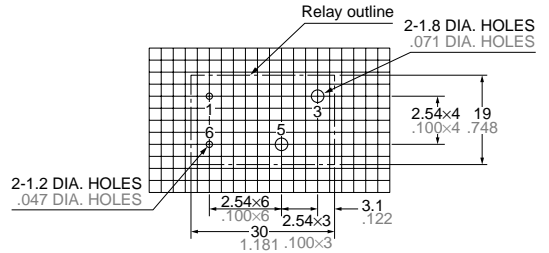

**PC board type
JC2a**

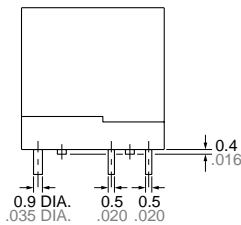
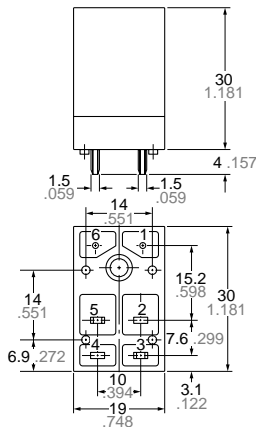

Schematic

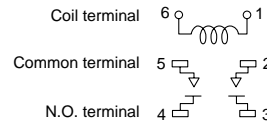

PC board pattern (Copper-side view)

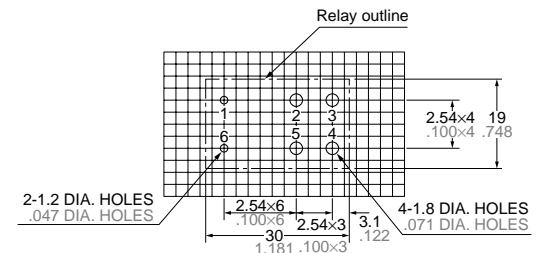

General tolerance: ±0.3 ±.012

Tolerance: ±0.1 ±.004

Top mount type

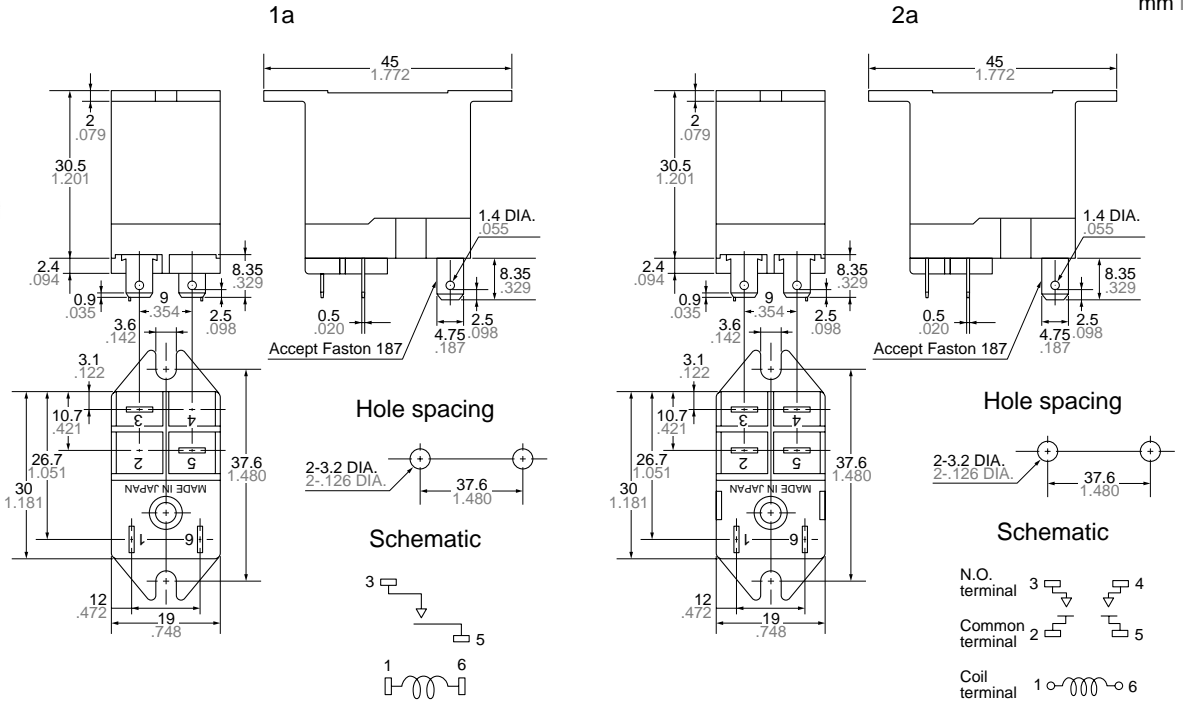

Plug-in type

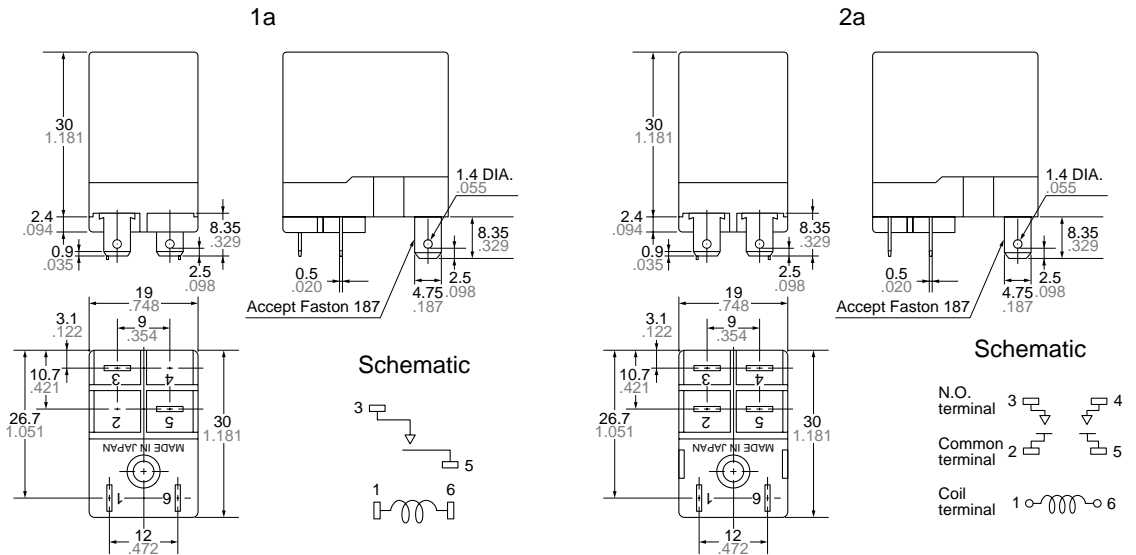

General tolerance: $\pm 0.3 \pm 0.12$

REFERENCE DATA

JC1a type

1. Maximum value for switching capacity

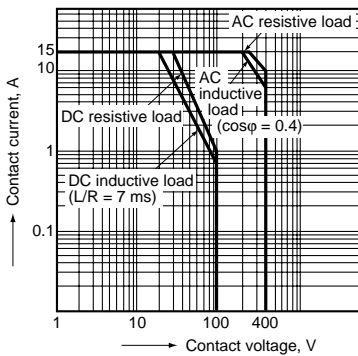

2. Life curve

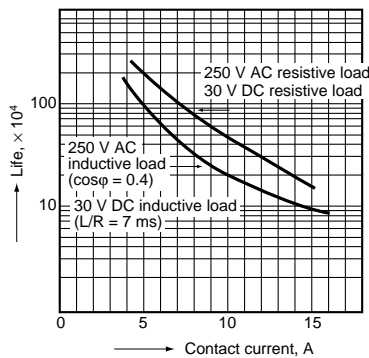

3.-(1) Coil temperature rise
Point measured: Inside the coil
Ambient temperature: 26°C 79°F

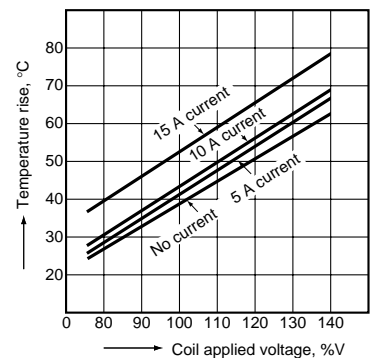

3.-(2) Coil temperature rise
 Point measured: Inside the coil
 Ambient temperature: 40°C 104°F

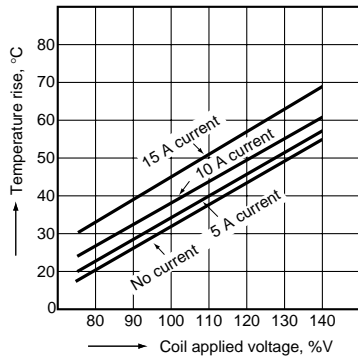

3.-(3) Coil temperature rise
 Point measured: Inside the coil
 Ambient temperature: 60°C 140°F

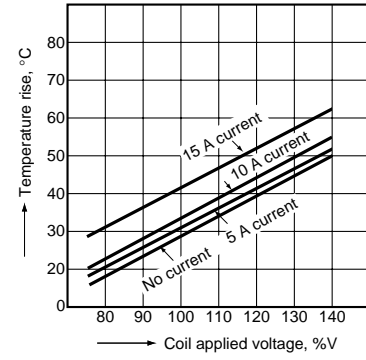

4. Operate / release time

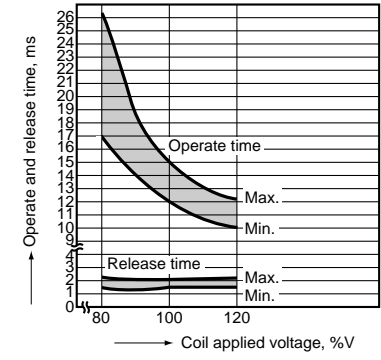

JC2a type

1. Maximum value for switching capacity

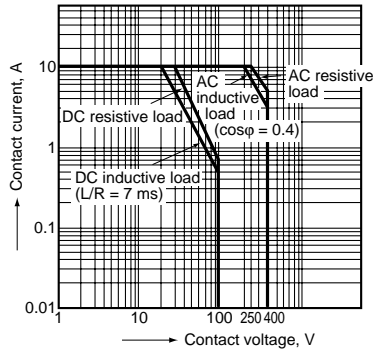

2. Life curve

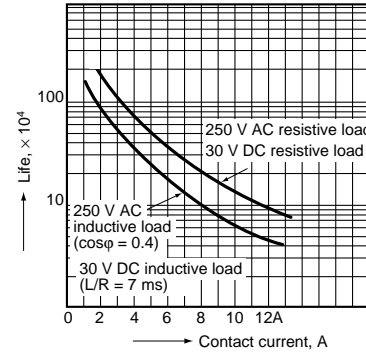

3.-(1) Coil temperature rise

Point measured: Inside the coil
 Ambient temperature: 26°C 79°F

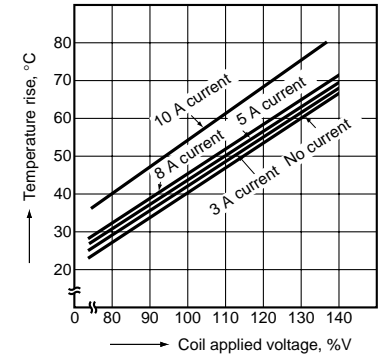

3.-(2) Coil temperature rise

Point measured: Inside the coil
 Ambient temperature: 40°C 104°F

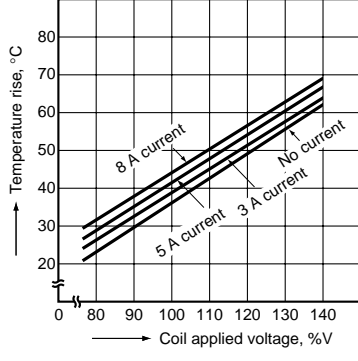

3.-(3) Coil temperature rise

Point measured: Inside the coil
 Ambient temperature: 60°C 140°F

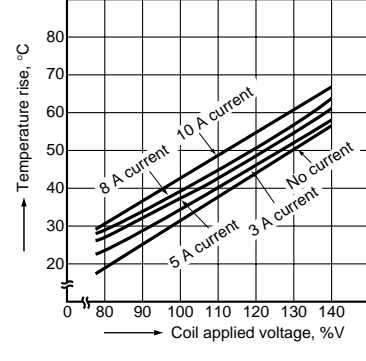

4. Operate / release time

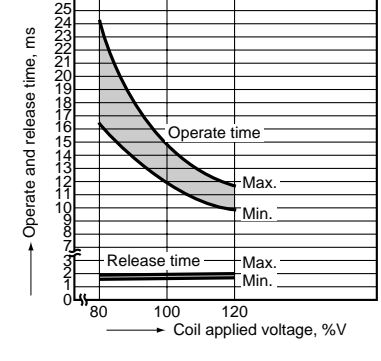

ACCESSORIES



JC1-SS



JC2-SS



JC1-PS



JC2-PS

JC2-SS

JC2-PS

mm inch

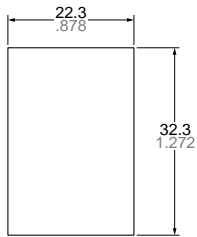
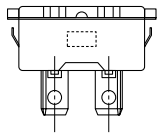
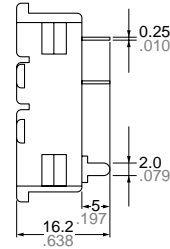
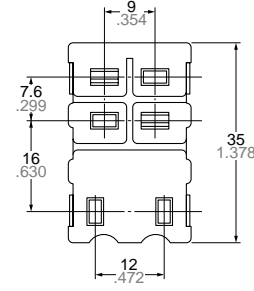
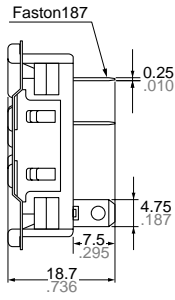
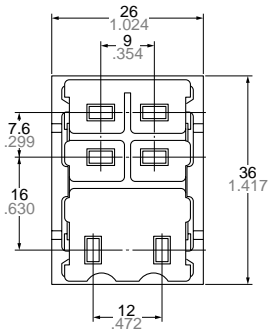

Panel cutout

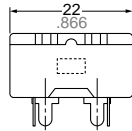

Tolerance: $\pm 0.1 \pm .004$

JC1-PS

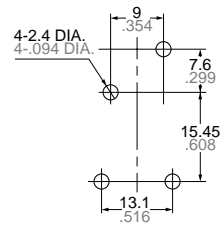

PC board Pattern

JC2-PS

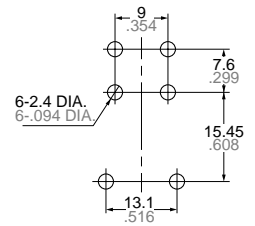

(Note)

Outward dimensions and chassis cutout dimensions for JC1-SS and JC1-PS are same as those of JC2-SS and JC2-PS respectively. UL/CSA approved type is standard.

For Cautions for Use, see Relay Technical Information (Page 11 to 39).