

High Performance Isolated Collector Silicon Bipolar Transistor

Technical Data

HBFP-0420

Features

- **Ideal for High Gain, Low Noise Applications**
- **Transition Frequency**
 $f_T = 25 \text{ GHz}$
- **Typical Performance at 1.8 GHz**
Associated Gain of 17 dB and Noise Figure of 1.1 dB at 2 V and 5 mA
 $P_{1\text{dB}}$ of 12 dBm at 2 V and 20 mA
- **Can be Used Without Impedance Matching**

Applications

- **LNA, Oscillator, Driver Amplifier, Buffer Amplifier, and Down Converter for Cellular and PCS Handsets and Cordless Telephones**
- **Oscillator for TV Delivery and TVRO Systems up to 10 GHz**

Surface Mount Plastic Package/SOT-343 (SC-70) Outline 4T

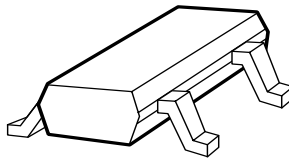

Pin Configuration

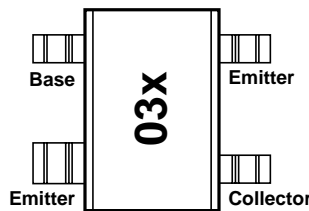

Note:
Package marking provides orientation and identification.
03 = Device code
x = Date code character. A new character is assigned for each month, year

Description

Agilent's HBFP-0420 is a high performance isolated collector silicon bipolar junction transistor housed in a 4-lead SC-70 (SOT-343) surface mount plastic package.

HBFP-0420 provides an associated gain of 17 dB, noise figure of 1.1 dB, and $P_{1\text{dB}}$ of 12 dBm at 1.8 GHz. Because of high gain and low current characteristics, HBFP-0420 is ideal for **cellular/PCS handsets** as well as for **C-Band and Ku-Band** applications.

This product is based on a 25 GHz transition frequency fabrication process, which enables the products to be used for high performance, low noise applications at 900 MHz, 1.9 GHz, 2.4 GHz, and beyond.

HBFP-0420 Absolute Maximum Ratings

Symbol	Parameter	Units	Absolute Maximum ^[1]
V_{EBO}	Emitter-Base Voltage	V	1.5
V_{CBO}	Collector-Base Voltage	V	15.0
V_{CEO}	Collector-Emitter Voltage	V	4.5
I_C	Collector Current	mA	36
P_T	Power Dissipation ^[2]	mW	162
T_j	Junction Temperature	°C	150
T_{STG}	Storage Temperature	°C	-65 to 150

Thermal Resistance:

$$\theta_{jc} = 300^\circ\text{C/W}$$

Notes:

1. Permanent damage may occur if any of these limits are exceeded.
2. P_T limited by maximum ratings.

Electrical Specifications, $T_C = 25^\circ\text{C}$

Symbol	Parameters and Test Conditions	Units	Min.	Typ.	Max.
DC Characteristics					
BV_{CEO}	Collector-Emitter Breakdown Voltage	$I_C = 1 \text{ mA}$, open base	V	4.5	
I_{CBO}	Collector-Cutoff Current	$V_{CB} = 5 \text{ V}$, $I_E = 0$	nA		200
I_{EBO}	Emitter-Base Cutoff Current	$V_{EB} = 1.5 \text{ V}$, $I_C = 0$	μA		35
h_{FE}	DC Current Gain	$V_{CE} = 2 \text{ V}$, $I_C = 5 \text{ mA}$	—	50	80
RF Characteristics					
F_{MIN}	Minimum Noise Figure	$I_C = 5 \text{ mA}$, $V_{CE} = 2 \text{ V}$, $f = 1.8 \text{ GHz}$	dB		1.1
G_a	Associated Gain	$I_C = 5 \text{ mA}$, $V_{CE} = 2 \text{ V}$, $f = 1.8 \text{ GHz}$	dB	15.5	17
$ S_{21} ^2$	Insertion Power Gain	$I_C = 20 \text{ mA}$, $V_{CE} = 2 \text{ V}$, $f = 1.8 \text{ GHz}$	dB		17
$P_{-1\text{dB}}$	Power Output @ 1 dB Compression Point	$I_C = 20 \text{ mA}$, $V_{CE} = 2 \text{ V}$, $f = 1.8 \text{ GHz}$	dBm		12

HBFP-0420 Typical Scattering Parameters, $V_{CE} = 2\text{ V}$, $I_C = 5\text{ mA}$, $T_C = 25^\circ\text{C}$

Freq. GHz	S_{11}		S_{21}			S_{12}			S_{22}	
	Mag	Ang	dB	Mag	Ang	dB	Mag	Ang	Mag	Ang
0.1	0.746	-11.9	23.4	14.853	171.0	-41.4	0.009	84.8	0.985	-6.6
0.5	0.682	-55.6	21.9	12.473	139.8	-28.5	0.038	63.6	0.861	-29.4
0.9	0.607	-90.1	19.9	9.909	116.8	-25.0	0.056	49.3	0.696	-46.6
1.0	0.585	-97.5	19.3	9.181	112.2	-24.5	0.059	46.9	0.661	-49.3
1.5	0.532	-128.3	16.8	6.918	93.1	-22.9	0.072	37.2	0.516	-62.2
1.8	0.512	-143.1	15.5	5.952	83.4	-22.3	0.077	33.2	0.450	-67.7
2.0	0.502	-151.6	14.7	5.453	78.4	-21.9	0.080	31.2	0.419	-71.6
2.5	0.490	-169.8	12.9	4.422	65.8	-21.2	0.088	26.9	0.359	-78.4
3.0	0.483	-174.6	11.6	3.786	55.2	-20.5	0.095	23.4	0.314	-86.3
3.5	0.480	161.4	10.3	3.286	45.2	-19.8	0.102	19.8	0.286	-92.5
4.0	0.479	149.2	9.3	2.908	35.7	-19.2	0.110	16.3	0.266	-98.1
4.5	0.482	137.6	8.4	2.629	26.5	-18.5	0.118	12.5	0.248	-104.1
5.0	0.487	126.5	7.6	2.389	17.4	-17.9	0.127	8.1	0.233	-110.5
5.5	0.497	115.4	6.9	2.205	8.3	-17.3	0.136	3.5	0.209	-117.9
6.0	0.513	105.0	6.2	2.040	-0.8	-16.8	0.145	-1.5	0.189	-126.4
6.5	0.532	94.6	5.6	1.902	-9.8	-16.3	0.153	-7.1	0.161	-137.1
7.0	0.553	84.0	5.0	1.778	-18.7	-15.8	0.162	-12.6	0.134	-152.0
7.5	0.575	74.5	4.4	1.662	-27.5	-15.3	0.171	-18.2	0.115	-171.2
8.0	0.592	66.0	3.9	1.559	-36.1	-14.9	0.179	-24.0	0.110	167.1
8.5	0.609	58.2	3.3	1.469	-44.4	-14.6	0.186	-29.8	0.113	147.2
9.0	0.623	50.7	2.9	1.393	-52.6	-14.2	0.195	-35.4	0.120	130.6
9.5	0.635	43.0	2.4	1.312	-60.8	-13.9	0.202	-41.6	0.127	118.0
10.0	0.648	34.5	1.9	1.248	-69.1	-13.6	0.209	-48.0	0.130	103.9

HBFP-0420 Noise Parameters: $V_{CE} = 2\text{ V}$, $I_C = 5\text{ mA}$

Freq. GHz	F_{min} dB	Γ_{opt}		R_N Ω	G_a dB
		Mag	Ang		
0.9	1.00	0.281	28.8	9.6	22.19
1.0	1.02	0.266	36.6	9.2	21.39
1.5	1.10	0.187	68.3	7.6	18.30
1.8	1.14	0.175	94.1	6.8	16.92
2.0	1.18	0.154	118.4	6.1	16.21
2.5	1.25	0.184	146.5	5.4	14.34
3.0	1.32	0.226	165.9	5.0	13.00
3.5	1.39	0.254	-176.8	4.9	11.79
4.0	1.49	0.292	-162.3	5.0	10.79
4.5	1.58	0.312	-147.3	6.0	9.95
5.0	1.63	0.355	-135.5	6.8	9.22
5.5	1.75	0.375	-121.0	9.3	8.55
6.0	1.88	0.416	-108.5	12.3	7.99
6.5	1.94	0.453	-98.1	15.8	7.47
7.0	2.05	0.486	-84.4	21.4	6.99
7.5	2.15	0.506	-74.8	26.8	6.49
8.0	2.23	0.532	-65.0	33.6	6.04
8.5	2.47	0.556	-56.8	41.7	5.65
9.0	2.59	0.589	-48.4	50.4	5.32
9.5	2.63	0.610	-40.4	58.2	4.91
10.0	2.74	0.624	-31.0	68.3	4.56

S and noise parameters are measured on a microstrip line made on 0.025 inch thick alumina carrier. The input reference plane is at the end of the base lead, the output reference plane is at the end of the collector lead. S and noise parameters include the effect of four plated through via holes connecting emitter landing pads on the top of test carrier to the microstrip ground plane on the bottom side of the carrier. Two 0.020 inch diameter via holes are placed within 0.010 inch from each emitter lead contact point, one via on each side of that point.

HBFP-0420 Typical Scattering Parameters, $V_{CE} = 2 \text{ V}$, $I_C = 15 \text{ mA}$, $T_C = 25^\circ\text{C}$

Freq. GHz	S_{11}		S_{21}			S_{12}			S_{22}	
	Mag	Ang	dB	Mag	Ang	dB	Mag	Ang	Mag	Ang
0.1	0.481	-22.1	29.1	28.438	166.1	-43.0	0.007	82.3	0.959	-10.5
0.5	0.437	-91.4	26.0	19.969	124.7	-31.2	0.027	60.7	0.702	-41.4
0.9	0.416	-131.0	22.6	13.526	101.9	-28.2	0.039	53.4	0.500	-57.2
1.0	0.414	-138.0	21.9	12.378	97.8	-27.7	0.041	52.9	0.465	-59.6
1.5	0.415	-163.4	18.7	8.619	81.9	-25.5	0.053	49.6	0.341	-69.8
1.8	0.418	-174.6	17.2	7.254	74.2	-24.4	0.060	47.9	0.292	-74.4
2.0	0.421	178.9	16.3	6.549	69.7	-23.7	0.065	46.6	0.269	-77.6
2.5	0.428	165.4	14.4	5.262	59.3	-22.3	0.077	42.9	0.226	-84.1
3.0	0.435	153.6	12.9	4.418	49.9	-21.0	0.089	38.8	0.196	-91.1
3.5	0.439	143.2	11.6	3.811	41.0	-19.9	0.101	34.1	0.177	-96.8
4.0	0.442	133.3	10.5	3.362	32.4	-18.9	0.113	29.0	0.163	-102.1
4.5	0.447	123.7	9.6	3.024	23.9	-18.1	0.125	23.7	0.152	-107.2
5.0	0.455	114.1	8.8	2.749	15.4	-17.3	0.137	17.9	0.138	-113.4
5.5	0.467	104.6	8.0	2.522	6.8	-16.6	0.148	11.8	0.120	-121.1
6.0	0.484	95.5	7.3	2.327	-1.8	-16.0	0.159	5.4	0.100	-131.4
6.5	0.504	86.0	6.7	2.163	-10.4	-15.4	0.169	-1.0	0.077	-148.2
7.0	0.527	76.7	6.1	2.014	-18.9	-14.9	0.179	-7.6	0.059	-178.2
7.5	0.552	68.0	5.5	1.880	-27.4	-14.5	0.188	-14.3	0.060	144.1
8.0	0.572	60.4	4.9	1.765	-35.5	-14.1	0.197	-20.6	0.077	116.6
8.5	0.590	53.3	4.4	1.658	-43.6	-13.8	0.205	-27.1	0.096	100.7
9.0	0.604	46.4	3.9	1.565	-51.6	-13.4	0.213	-33.6	0.112	89.0
9.5	0.616	39.2	3.4	1.484	-59.6	-13.1	0.221	-40.3	0.123	77.9
10.0	0.630	31.4	3.0	1.406	-67.7	-12.9	0.228	-47.2	0.134	66.5

HBFP-0420 Noise Parameters: $V_{CE} = 2 \text{ V}$, $I_C = 15 \text{ mA}$

Freq. GHz	F_{min} dB	Γ_{opt}		R_N Ω	G_a dB
		Mag	Ang		
0.9	1.57	0.033	-135.5	8.0	23.88
1.0	1.58	0.054	-151.8	7.8	23.04
1.5	1.63	0.169	-155.2	6.7	19.79
1.8	1.67	0.252	-148.1	6.3	18.34
2.0	1.74	0.234	-158.3	6.4	17.52
2.5	1.72	0.306	-149.2	6.1	15.71
3.0	1.76	0.343	-142.2	6.5	14.24
3.5	1.84	0.365	-133.5	7.7	12.97
4.0	1.89	0.383	-124.4	9.4	11.89
4.5	1.97	0.407	-115.6	11.5	11.01
5.0	2.03	0.431	-106.3	14.1	10.22
5.5	2.15	0.463	-96.8	17.8	9.53
6.0	2.28	0.483	-87.3	22.9	8.89
6.5	2.36	0.513	-77.3	28.7	8.32
7.0	2.42	0.538	-67.8	35.5	7.79
7.5	2.54	0.560	-59.2	43.0	7.30
8.0	2.65	0.581	-51.4	51.7	6.85
8.5	2.83	0.602	-44.6	61.3	6.42
9.0	2.96	0.621	-37.2	71.0	5.99
9.5	3.10	0.640	-29.9	81.1	5.61
10.0	3.14	0.653	-21.8	90.5	5.23

S and noise parameters are measured on a microstrip line made on 0.025 inch thick alumina carrier. The input reference plane is at the end of the base lead, the output reference plane is at the end of the collector lead. S and noise parameters include the effect of four plated through via holes connecting emitter landing pads on the top of test carrier to the microstrip ground plane on the bottom side of the carrier. Two 0.020 inch diameter via holes are placed within 0.010 inch from each emitter lead contact point, one via on each side of that point.

HBFP-0420 Typical Performance

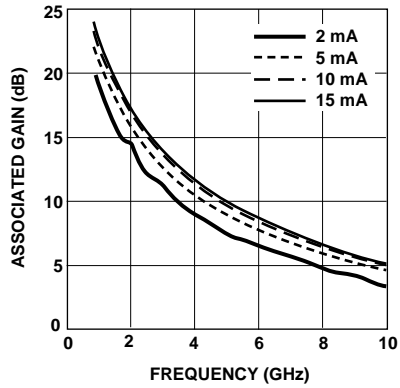

Figure 1. Associated Gain vs. Frequency and Collector Current at 2 V.

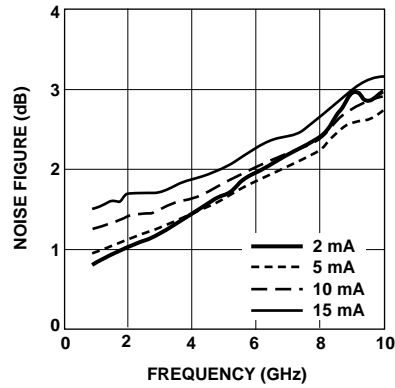

Figure 2. Noise Figure vs. Frequency and Collector Current at 2 V.

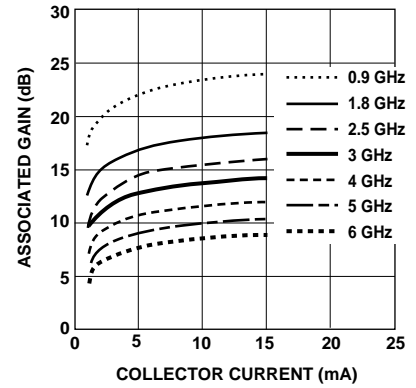

Figure 3. Associated Gain vs. Collector Current and Frequency at 2 V.

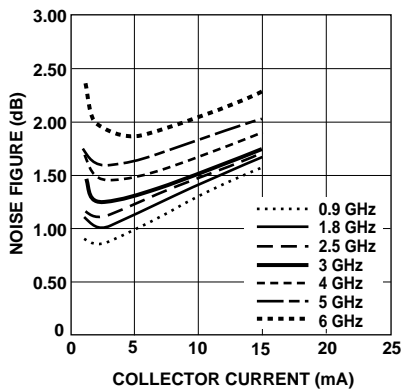

Figure 4. Noise Figure vs. Collector Current and Frequency at 2 V.

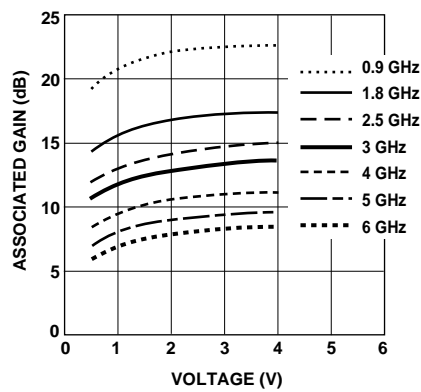

Figure 5. Associated Gain vs. Voltage (V_{CE}) at 5 mA.

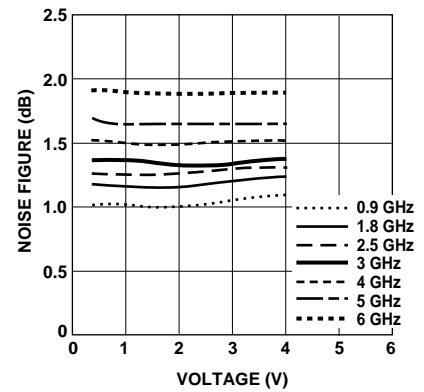
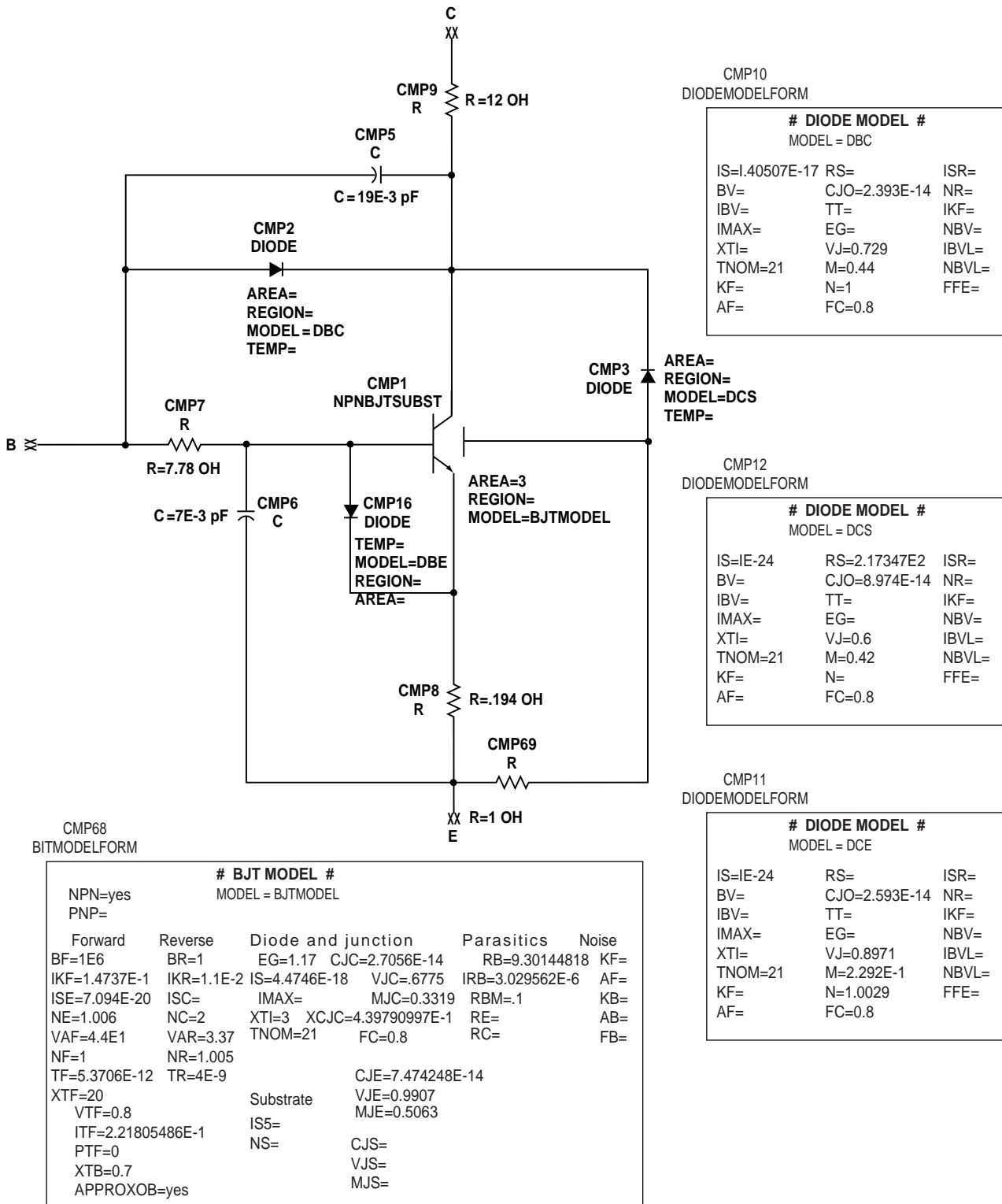

Figure 6. Noise Figure vs. Voltage (V_{CE}) at 5 mA.

HBFP-0420 Die Model and PSPICE Parameters



This model can be used as a design tool. It has been tested on MDS for various specifications. However, for more precise and accurate design, please refer to the measured data in this data sheet.

Note: The value of beta was high (BF = 1E6) to compensate for the fact that diode DBE reduces the current going into the base (current flows through DBE). The diodes are necessary to model the non-linear effects.

SOT343 Package Model

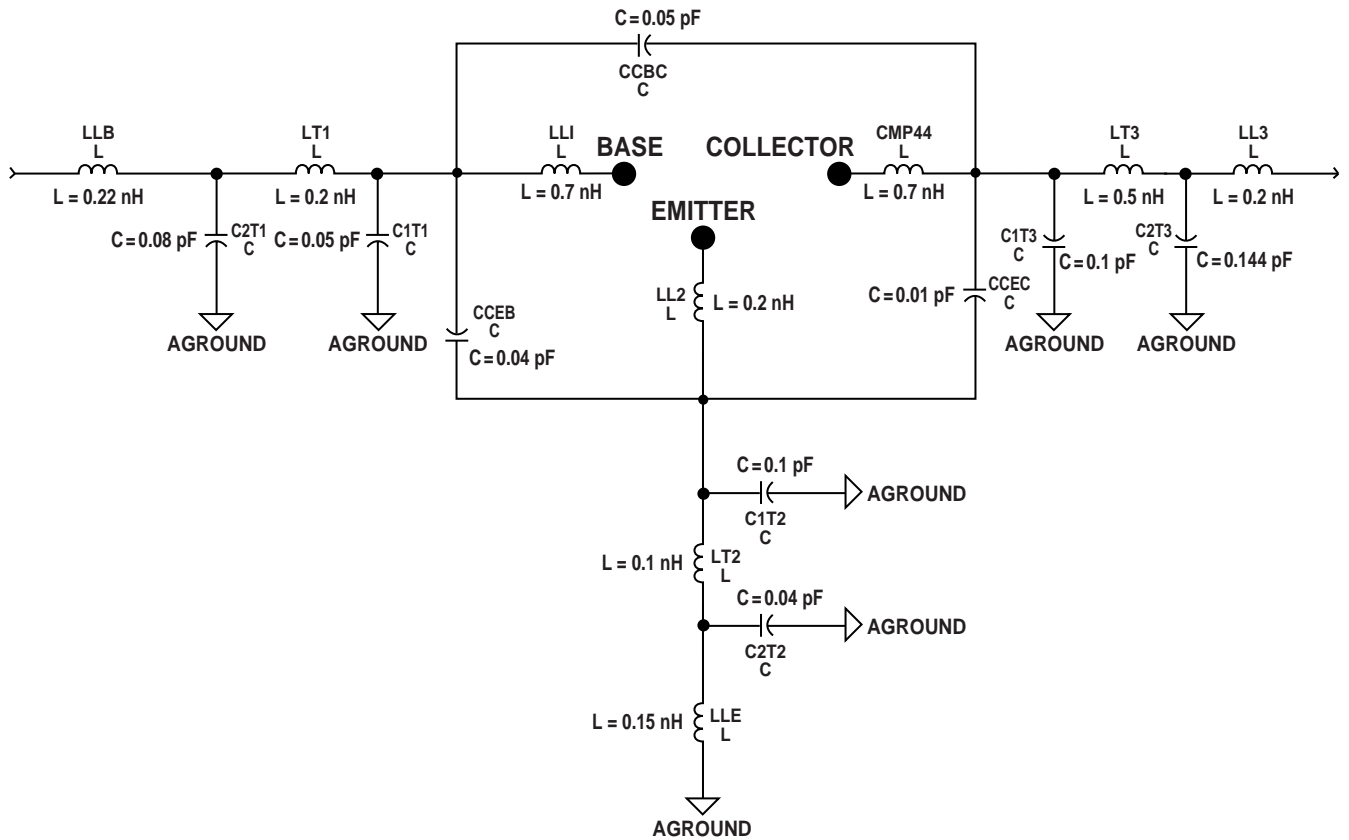

Part Number Ordering Information

Part Number	Devices per Reel	Container	Tape Orientation
HBFP-0420-BLK	100	antistatic bag	none
HBFP-0420-TR1	3000	7" Reel	standard
HBFP-0420-TR2	10,000	13" Reel	standard
HBFP-0420-TR3	3000	7" Reel	reverse

Package Dimensions SOT-343 (SC-70 4 Lead)

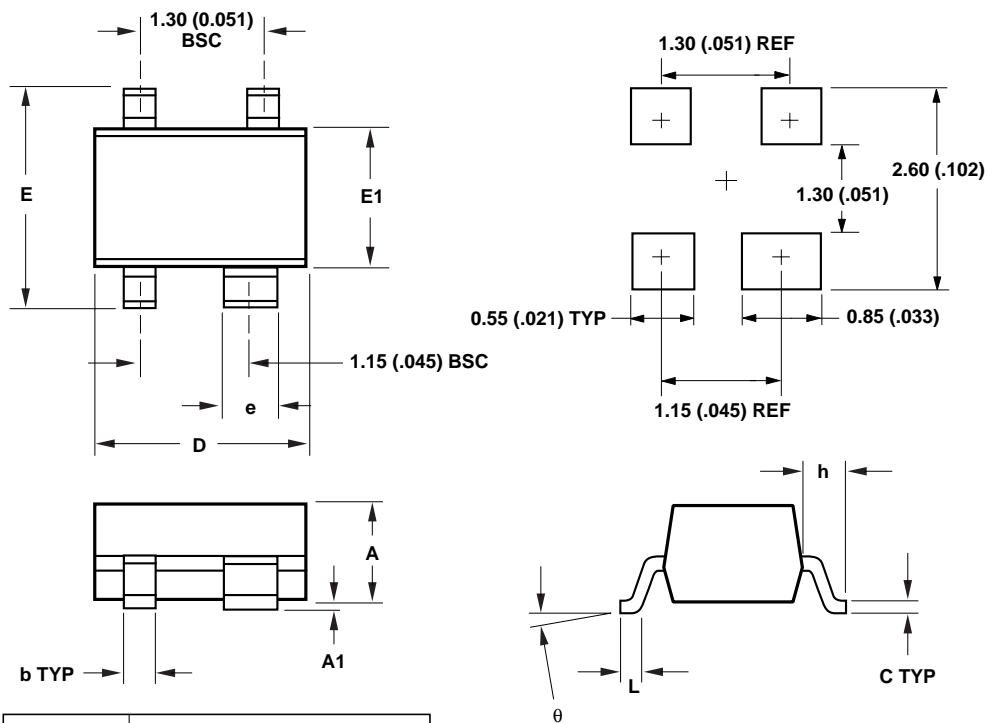

SYMBOL	DIMENSIONS	
	MIN.	MAX.
A	0.80 (0.031)	1.00 (0.039)
A1	0 (0)	0.10 (0.004)
b	0.25 (0.010)	0.35 (0.014)
C	0.10 (0.004)	0.20 (0.008)
D	1.90 (0.075)	2.10 (0.083)
E	2.00 (0.079)	2.20 (0.087)
e	0.55 (0.022)	0.65 (0.025)
h	0.450 TYP (0.018)	
E1	1.15 (0.045)	1.35 (0.053)
L	0.10 (0.004)	0.35 (0.014)
θ	0	10

DIMENSIONS ARE IN MILLIMETERS (INCHES)

Device Orientation

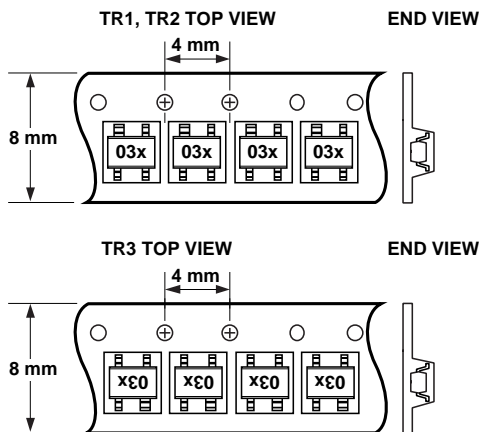
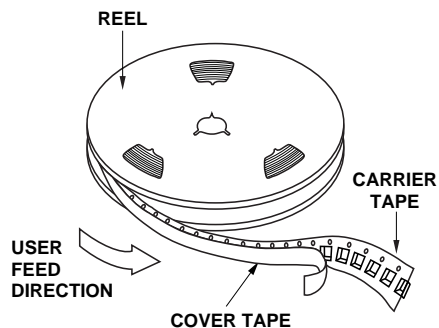

Tape Dimensions For Outline 4T

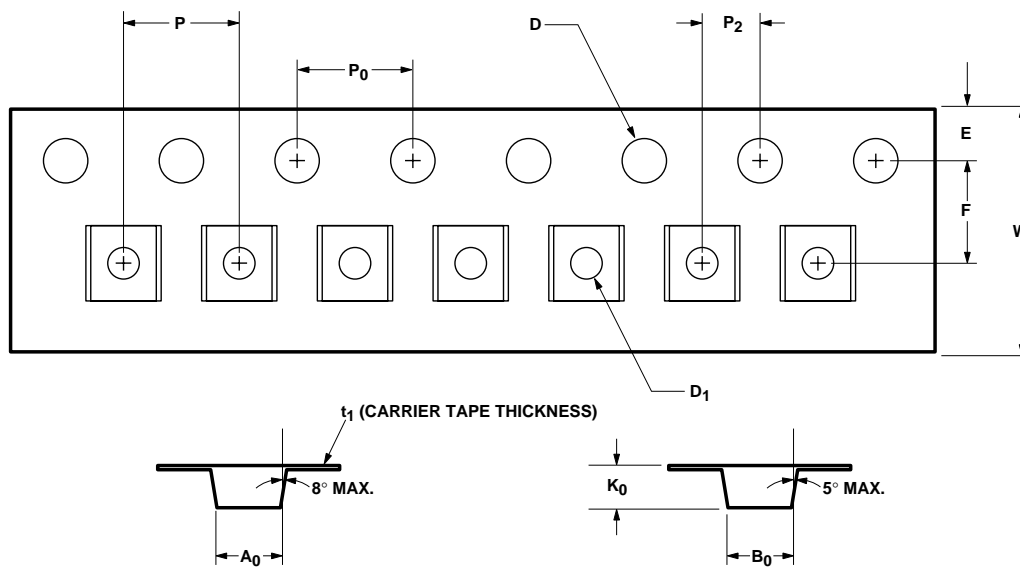

DESCRIPTION		SYMBOL	SIZE (mm)	SIZE (INCHES)
CAVITY	LENGTH	A ₀	2.24 ± 0.10	0.088 ± 0.004
	WIDTH	B ₀	2.34 ± 0.10	0.092 ± 0.004
	DEPTH	K ₀	1.22 ± 0.10	0.048 ± 0.004
	PITCH	P	4.00 ± 0.10	0.157 ± 0.004
	BOTTOM HOLE DIAMETER	D ₁	1.00 + 0.25	0.039 + 0.010
PERFORATION	DIAMETER	D	1.55 ± 0.05	0.061 ± 0.002
	PITCH	P ₀	4.00 ± 0.10	0.157 ± 0.004
	POSITION	E	1.75 ± 0.10	0.069 ± 0.004
CARRIER TAPE	WIDTH	W	8.00 ± 0.30	0.315 ± 0.012
	THICKNESS	t ₁	0.255 ± 0.013	0.010 ± 0.0005
DISTANCE	CAVITY TO PERFORATION (WIDTH DIRECTION)	F	3.50 ± 0.05	0.138 ± 0.002
	CAVITY TO PERFORATION (LENGTH DIRECTION)	P ₂	2.00 ± 0.05	0.079 ± 0.002



Agilent Technologies

Innovating the HP Way

www.semiconductor.agilent.com

Data subject to change.

Copyright © 2000 Agilent Technologies, Inc.

Obsoletes 5968-5433E

5988-0132EN (9/00)