

# 8 mm (0.31 inch) Ultra Mini Seven Segment Displays

## Technical Data

- HDSP-U0xx Series**
- HDSP-U1xx Series**
- HDSP-U2xx Series**
- HDSP-U3xx Series**
- HDSP-U4xx Series**
- HDSP-U5xx Series**

### Features

- **Compact Package**
- **8 mm (0.31 inch) Character Height**
- **Choice of Colors**  
Wide Range of Colors
- **Excellent Appearance**  
Evenly Lighted Segments  
Mitered Corners on Segments  
Gray/Black Surface Gives Optimum Contrast  
± 50° Viewing Angle
- **Design Flexibility**  
Common Anode or Common Cathode  
Right Hand Decimal Point
- **Categorized for Luminous Intensity**  
Yellow and Green also Categorized for Color  
Use of Like Categories Yields a Uniform Display

- **High Light Output**
- **High Peak Current**
- **Excellent for Long Digit String Multiplexing**
- **Intensity and Color Selection Option**

### Description

The 8 mm (0.31 inch) LED seven segment displays are Agilent's most space-efficient character size. They are designed for viewing distances up to 3 metres (10 feet). The numeric devices feature a right hand decimal point. All devices are available as either common anode or common cathode.

Typical applications include appliances, temperature controllers, and digital panel meters.



### Devices

<b>Red HDSP-</b>	<b>AlGaAs Red HDSP-</b>	<b>HER HDSP-</b>	<b>Orange HDSP-</b>	<b>Yellow HDSP-</b>	<b>Green HDSP-</b>	<b>Description</b>	<b>Circuit Diagram</b>
U001	U101	U201	U401	U301	U501	Common Anode, Right Hand Decimal, Gray Surface	A
U003	U103	U203	U403	U303	U503	Common Cathode, Right Hand Decimal, Gray Surface	B
U011	U111	U211	U411	U311	U511	Common Anode, Right Hand Decimal, Black Surface	A
U013	U113	U213	U413	U313	U513	Common Cathode, Right Hand Decimal, Black Surface	B

### Package Dimensions

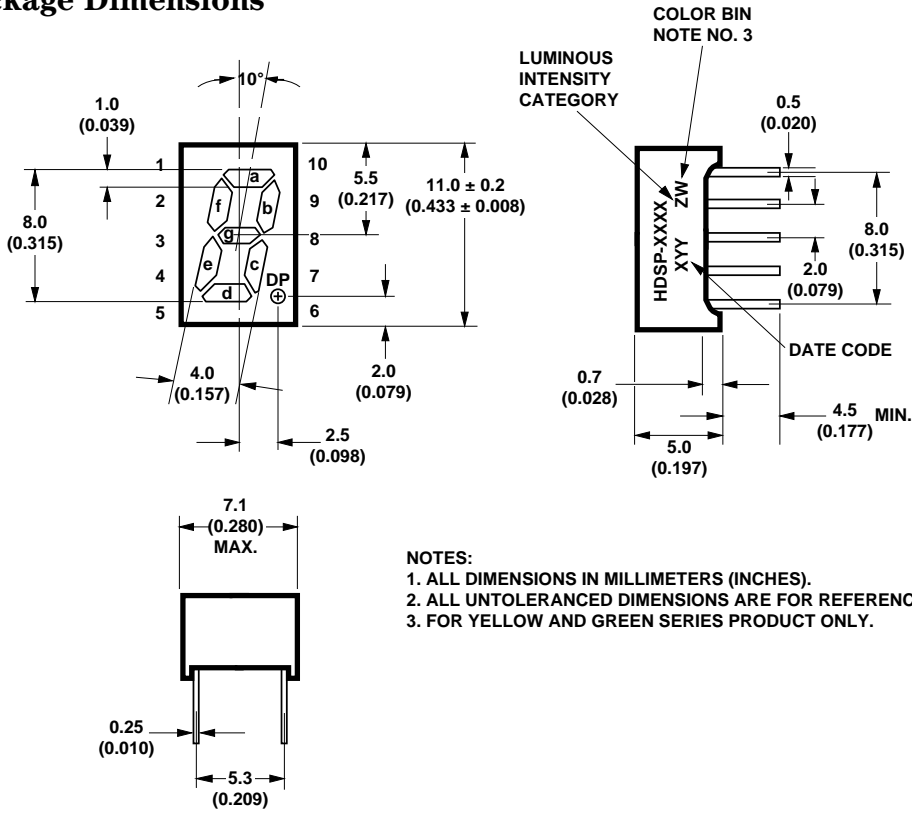

### Internal Circuit Diagram

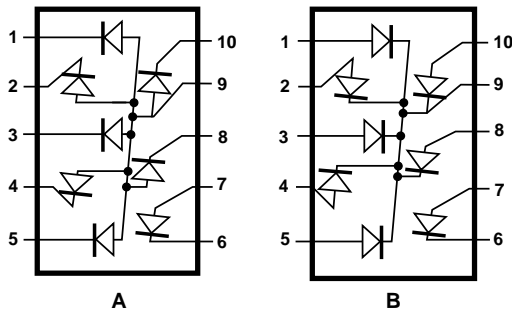

PIN	FUNCTION	
	A	B
1	CATHODE a	ANODE a
2	CATHODE f	ANODE f
3	CATHODE g	ANODE g
4	CATHODE e	ANODE e
5	CATHODE d	ANODE d
6	CATHODE DP	CATHODE DP
7	ANODE DP	ANODE DP
8	CATHODE c	ANODE c
9	ANODE	CATHODE
10	CATHODE b	ANODE b

HDSP-UXXX CIRCUIT

## Absolute Maximum Ratings

Description	Red HDSP-U0XX Series	AlGaAs Red HDSP-U1XX Series	HER/Orange HDSP-U2XX/-4XX Series	Yellow HDSP-U3XX Series	Green HDSP-U5XX Series	Units
Average Power per Segment or DP	82	37	105	80	105	mW
Peak Forward Current per Segment or DP	150 <sup>[1]</sup>	45 <sup>[3]</sup>	90 <sup>[5]</sup>	60 <sup>[7]</sup>	90 <sup>[9]</sup>	mA
DC Forward Current per Segment or DP	25 <sup>[2]</sup>	15 <sup>[4]</sup>	30 <sup>[6]</sup>	20 <sup>[8]</sup>	30 <sup>[10]</sup>	mA
Operating Temperature Range	-25 to +90	-20 to +90	-25 to +90			°C
Storage Temperature Range	-30 – +90					°C
Reverse Voltage per Segment or DP	3.0					V
Lead Solder Temperature for 3 Seconds (1.60 mm [0.063 in.] below seating plane)	260					°C

### Notes:

- See Figure 1 to establish pulsed conditions.
- Derate above 80°C at 0.63 mA/°C (see figure 3).
- See Figure 2 to establish pulsed conditions.
- No derating over specified temperature range.
- See Figure 7 to establish pulsed conditions.
- Derate above 53°C at 0.45 mA/°C (see figure 10).
- See Figure 8 to establish pulsed conditions.
- Derate above 81°C at 0.52 mA/°C (see figure 10).
- See Figure 9 to establish pulsed conditions.
- Derate above 39°C at 0.37 mA/°C (see figure 10).

## Electrical/Optical Characteristics at T<sub>A</sub> = 25°C

### Red

Device Series	Parameter	Symbol	Min.	Typ.	Max.	Units	Test Conditions
HDSP-U0XX	Luminous Intensity/Segment <sup>[1,2]</sup> (Digit Average)	I <sub>V</sub>	600	1100		μcd	I <sub>F</sub> = 20 mA
				500			I <sub>F</sub> = 10 mA
	Forward Voltage/Segment or DP	V <sub>F</sub>		1.6	2.0	V	I <sub>F</sub> = 20 mA
	Peak Wavelength	λ <sub>PEAK</sub>		655		nm	
	Dominant Wavelength <sup>[3]</sup>	λ <sub>d</sub>		640		nm	
	Reverse Voltage/Segment or DP <sup>[4]</sup>	V <sub>R</sub>	3.0	12		V	I <sub>R</sub> = 100 μA
	Temperature Coefficient of V <sub>F</sub> /Segment or DP	ΔV <sub>F</sub> /°C		-2		mV/°C	
Thermal Resistance LED Junction-to-Pin	Rθ <sub>J-Pin</sub>		200		°C/W/ Seg		

**AlGaAs Red**

Device Series	Parameter	Symbol	Min.	Typ.	Max.	Units	Test Conditions
HDSP-U1XX	Luminous Intensity/Segment <sup>[1,2]</sup> (Digit Average)	$I_V$	315	600		$\mu\text{cd}$	$I_F = 1 \text{ mA}$
				3600			$I_F = 5 \text{ mA}$
	Forward Voltage/Segment or DP	$V_F$		1.6		V	$I_F = 1 \text{ mA}$
				1.7			$I_F = 5 \text{ mA}$
				1.8	2.2		$I_F = 20 \text{ mA}$
	Peak Wavelength	$\lambda_{\text{PEAK}}$		645		nm	
	Dominant Wavelength <sup>[3]</sup>	$\lambda_d$		637		nm	
	Reverse Voltage/Segment or DP <sup>[4]</sup>	$V_R$	3.0	15		V	$I_R = 100 \mu\text{A}$
Temperature Coefficient of $V_F$ /Segment or DP	$\Delta V_F/^\circ\text{C}$		-2		mV/°C		
Thermal Resistance LED Junction-to-Pin	$R\theta_{\text{J-Pin}}$		255		°C/W/ Seg		

**High Efficiency Red**

Device Series	Parameter	Symbol	Min.	Typ.	Max.	Units	Test Conditions
HDSP-U2XX	Luminous Intensity/Segment <sup>[1,2]</sup> (Digit Average)	$I_V$	360	980		$\mu\text{cd}$	$I_F = 5 \text{ mA}$
				5390			$I_F = 20 \text{ mA}$
	Forward Voltage/Segment or DP	$V_F$		2.0	2.5	V	$I_F = 20 \text{ mA}$
	Peak Wavelength	$\lambda_{\text{PEAK}}$		635		nm	
	Dominant Wavelength <sup>[3]</sup>	$\lambda_d$		626		nm	
	Reverse Voltage/Segment or DP <sup>[4]</sup>	$V_R$	3.0	30		V	$I_R = 100 \mu\text{A}$
	Temperature Coefficient of $V_F$ /Segment or DP	$\Delta V_F/^\circ\text{C}$		-2		mV/°C	
Thermal Resistance LED Junction-to-Pin	$R\theta_{\text{J-Pin}}$		200		°C/W/ Seg		

**Orange**

Device Series	Parameter	Symbol	Min.	Typ.	Max.	Units	Test Conditions
HDSP-U4XX	Luminous Intensity/Segment <sup>[1,2]</sup> (Digit Average)	I <sub>V</sub>	360	980		μcd	I <sub>F</sub> = 5 mA
				5390			I <sub>F</sub> = 20 mA
	Forward Voltage/Segment or DP	V <sub>F</sub>		2.0	2.5	V	I <sub>F</sub> = 20 mA
	Peak Wavelength	λ <sub>PEAK</sub>		600		nm	
	Dominant Wavelength <sup>[3]</sup>	λ <sub>d</sub>		603		nm	
	Reverse Voltage/Segment or DP <sup>[4]</sup>	V <sub>R</sub>	3.0	30		V	I <sub>R</sub> = 100 μA
	Temperature Coefficient of V <sub>F</sub> /Segment or DP	ΔV <sub>F</sub> /°C		-2		mV/°C	
Thermal Resistance LED Junction-to-Pin	Rθ <sub>J-Pin</sub>		200		°C/W/ Seg		

**Yellow**

Device Series	Parameter	Symbol	Min.	Typ.	Max.	Units	Test Conditions
HDSP-U3XX	Luminous Intensity/Segment <sup>[1,2]</sup> (Digit Average)	I <sub>V</sub>	225	480		μcd	I <sub>F</sub> = 5 mA
				2740			I <sub>F</sub> = 20 mA
	Forward Voltage/Segment or DP	V <sub>F</sub>		2.2	2.5	V	I <sub>F</sub> = 20 mA
	Peak Wavelength	λ <sub>PEAK</sub>		583		nm	
	Dominant Wavelength <sup>[3,5]</sup>	λ <sub>d</sub>	581.5	586	592.5	nm	
	Reverse Voltage/Segment or DP <sup>[4]</sup>	V <sub>R</sub>	3.0	50.0		V	I <sub>R</sub> = 100 μA
	Temperature Coefficient of V <sub>F</sub> /Segment or DP	ΔV <sub>F</sub> /°C		-2		mV/°C	
Thermal Resistance LED Junction-to-Pin	Rθ <sub>J-Pin</sub>		200		°C/W/ Seg		

**High Performance Green**

Device Series	Parameter	Symbol	Min.	Typ.	Max.	Units	Test Conditions
HDSP-U5XX	Luminous Intensity/Segment <sup>[1,2]</sup> (Digit Average)	I <sub>V</sub>	860	3000		μcd	I <sub>F</sub> = 10 mA
				6800			I <sub>F</sub> = 20 mA
	Forward Voltage/Segment or DP	V <sub>F</sub>		2.1	2.5	V	I <sub>F</sub> = 10 mA
	Peak Wavelength	λ <sub>PEAK</sub>		566		nm	
	Dominant Wavelength <sup>[3,5]</sup>	λ <sub>d</sub>		571		nm	
	Reverse Voltage/Segment or DP <sup>[4]</sup>	V <sub>R</sub>	3.0	50.0		V	I <sub>R</sub> = 100 μA
	Temperature Coefficient of V <sub>F</sub> /Segment or DP	ΔV <sub>F</sub> /°C		-2		mV/°C	
Thermal Resistance LED Junction-to-Pin	Rθ <sub>J-Pin</sub>		200		°C/W/ Seg		

**Notes:**

- Case temperature of device immediately prior to the intensity measurement is 25°C.
- The digits are categorized for luminous intensity. The intensity category is designated by a letter on the side of the package.
- The dominant wavelength, λ<sub>d</sub>, is derived from the CIE chromaticity diagram and is that single wavelength which defines the color of the device.
- Typical specification for reference only. Do not exceed absolute maximum ratings.
- The Yellow (HDSP-U3XX) series and Green (HDSP-U5XX) series displays are categorized for dominant wavelength. The category is designated by a number adjacent to the luminous intensity category letter.

### Red, AlGaAs Red

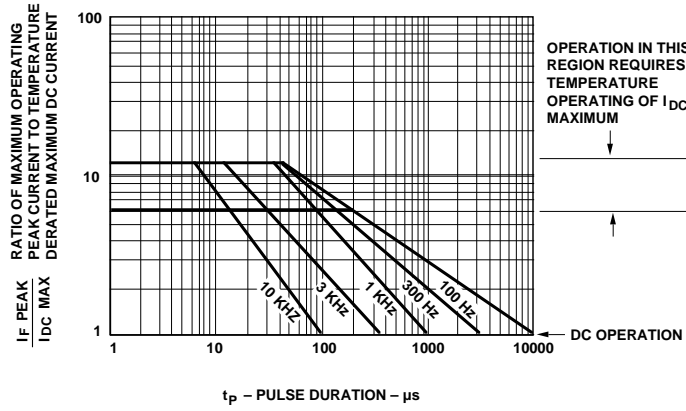

Figure 1. Maximum Tolerable Peak Current vs. Pulse Duration - Red.

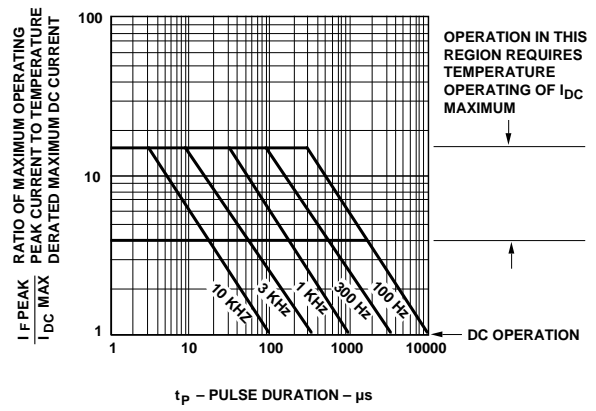

Figure 2. Maximum Tolerable Peak Current vs. Pulse Duration - AlGaAs Red.

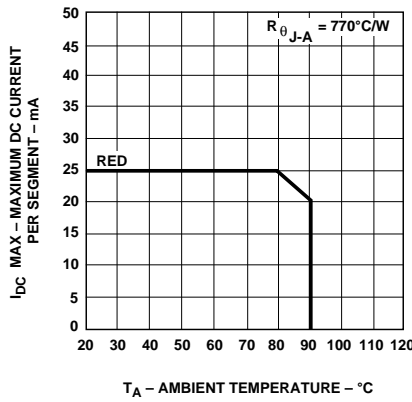

Figure 3. Maximum Allowable DC Current vs. Ambient Temperature.

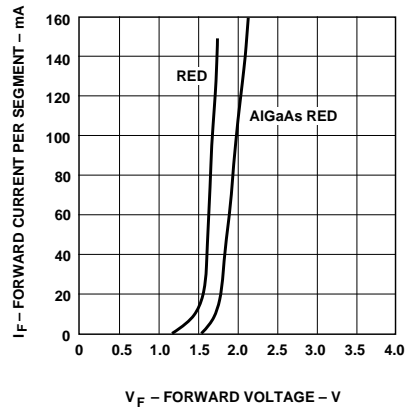

Figure 4. Forward Current vs. Forward Voltage.

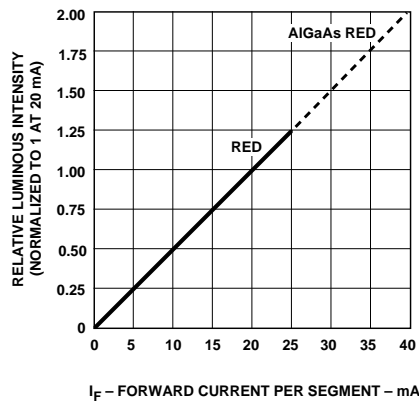

Figure 5. Relative Luminous Intensity vs. DC Forward Current.

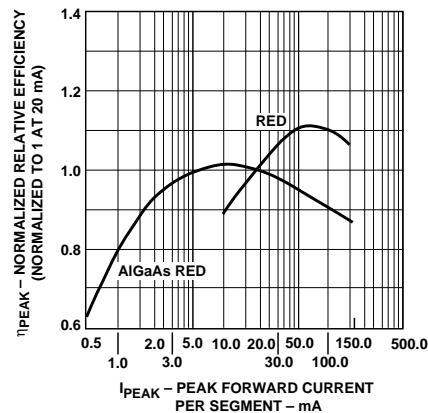

Figure 6. Relative Efficiency (Luminous Intensity per Unit Current) vs. Peak Current.

## HER, Orange, Yellow, Green

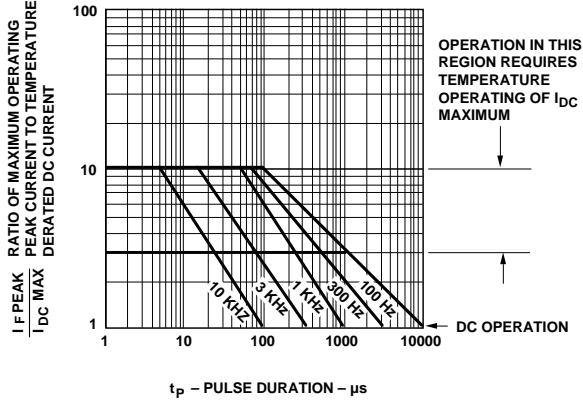

Figure 7. Maximum Tolerable Peak Current vs. Pulse Duration – HER, Orange.

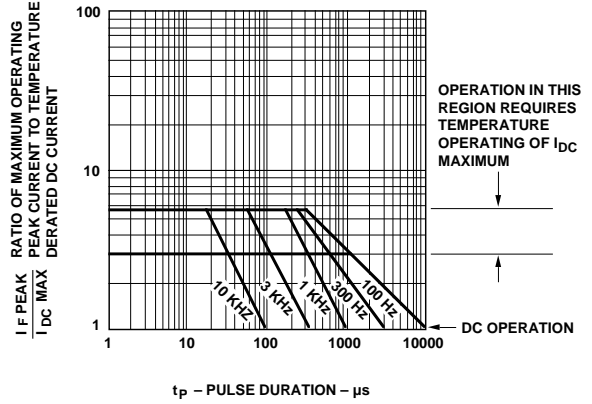

Figure 8. Maximum Tolerable Peak Current vs. Pulse Duration – Yellow.

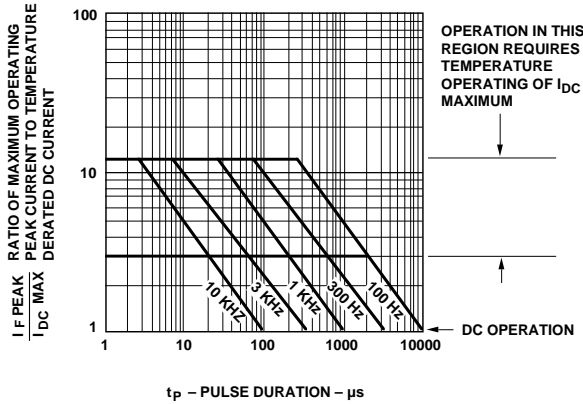

Figure 9. Maximum Tolerable Peak Current vs. Pulse Duration – Green.

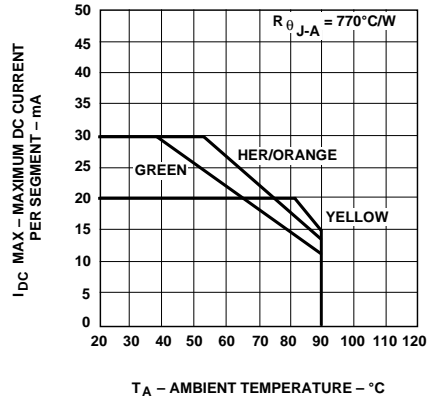

Figure 10. Maximum Allowable DC Current vs. Ambient Temperature.

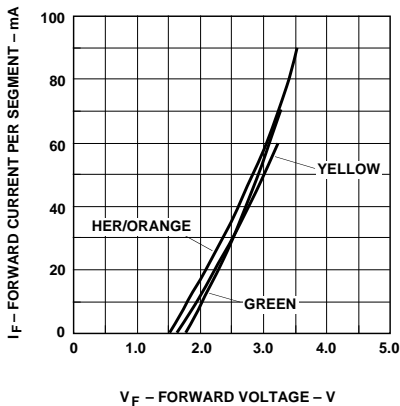

Figure 11. Forward Current vs. Forward Voltage Characteristics.

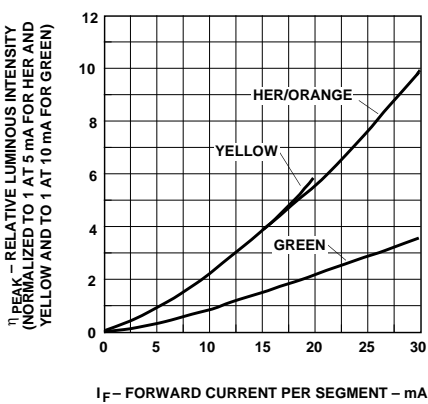

Figure 12. Relative Luminous Intensity vs. DC Forward Current.

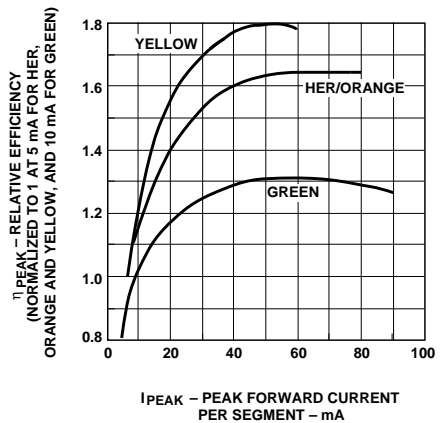
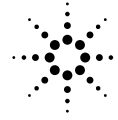

Figure 13. Relative Efficiency (Luminous Intensity per Unit Current) vs. Peak Current.



### **Electrical/Optical**

For more information on electrical/optical characteristics, please see Application Note 1005.

### **Contrast Enhancement**

For information on contrast enhancement please see Application Note 1015.

### **Soldering/Cleaning**

Cleaning agents from the ketone family (acetone, methyl ethyl ketone, etc.) and from the chlorinated hydrocarbon family

(methylene chloride, trichloroethylene, carbon tetrachloride, etc.) are not recommended for cleaning LED parts. All of these various solvents attack or dissolve the encapsulating materials used to form the package of plastic LED parts.

For more information on soldering LEDs please refer to Application Note 1027.