

Notice for TAIYO YUDEN products

Please read this notice before using the TAIYO YUDEN products.



REMINDERS

- Product information in this catalog is as of October 2008. All of the contents specified herein are subject to change without notice due to technical improvements, etc. Therefore, please check for the latest information carefully before practical application or usage of the Products.

Please note that Taiyo Yuden Co., Ltd. shall not be responsible for any defects in products or equipment incorporating such products, which are caused under the conditions other than those specified in this catalog or individual specification.

- Please contact Taiyo Yuden Co., Ltd. for further details of product specifications as the individual specification is available.
- Please conduct validation and verification of products in actual condition of mounting and operating environment before commercial shipment of the equipment.
- All electronic components or functional modules listed in this catalog are developed, designed and intended for use in general electronics equipment.(for AV, office automation, household, office supply, information service, telecommunications, (such as mobile phone or PC) etc.). Before incorporating the components or devices into any equipment in the field such as transportation,(automotive control, train control, ship control), transportation signal, disaster prevention, medical, public information network (telephone exchange, base station) etc. which may have direct influence to harm or injure a human body, please contact Taiyo Yuden Co., Ltd. for more detail in advance.

Do not incorporate the products into any equipment in fields such as aerospace, aviation, nuclear control, submarine system, military, etc. where higher safety and reliability are especially required.

In addition, even electronic components or functional modules that are used for the general electronic equipment, if the equipment or the electric circuit require high safety or reliability function or performances, a sufficient reliability evaluation check for safety shall be performed before commercial shipment and moreover, due consideration to install a protective circuit is strongly recommended at customer's design stage.

- The contents of this catalog are applicable to the products which are purchased from our sales offices or distributors (so called "TAIYO YUDEN' s official sales channel").
It is only applicable to the products purchased from any of TAIYO YUDEN' s official sales channel.
- Please note that Taiyo Yuden Co., Ltd. shall have no responsibility for any controversies or disputes that may occur in connection with a third party's intellectual property rights and other related rights arising from your usage of products in this catalog. Taiyo Yuden Co., Ltd. grants no license for such rights.
- Caution for export
Certain items in this catalog may require specific procedures for export according to "Foreign Exchange and Foreign Trade Control Law" of Japan, "U.S. Export Administration Regulations," and other applicable regulations. Should you have any question or inquiry on this matter, please contact our sales staff.
Should you have any question or inquiry on this matter, please contact our sales staff.

高周波積層チップインダクタ

MULTILAYER CHIP INDUCTOR

FOR HIGH FREQUENCY

HK SERIES



* HK0603, HK1005を除く
* Except for HK0603, HK1005

OPERATING TEMP.	0603 : -55~125°C
	1005 : -55~125°C **
	-55~85°C **
	1608 : -40~85°C
	2125 : -40~85°C

** 保証定格電流により変わります。
** Operating temperature depends on rated current.

特長 FEATURES

- 内部導体として比抵抗値の低いAgを使用し、良好なQ特性と自己共振周波数特性を実現
- 積層シート工法による、高生産性、高品質、高インダクタンス値対応
- モノリシック構造のため、高い信頼性を有する
- Multilayer inductor made of advanced ceramics with low-resistivity silver used as internal conductors provides excellent Q and SRF characteristics.
- Designed to address surface mount inductor needs for applications above 100MHz.
- Multilayer block structure ensures outstanding reliability, high productivity and product quality.

用途 APPLICATIONS

- 携帯電話、PHS、無線LAN
- その他の高周波回路、中間周波増幅回路
- 高周波帯域でのEMI対策
- Portable telephones, PHS and W-LAN
- Miscellaneous high-frequency circuits
- EMI countermeasure in high-frequency circuits.

形名表記法 ORDERING CODE

1	2	3	4	5
形式	形状寸法 (L×W) [mm]	公称インダクタンス [nH]	インダクタンス許容差	包装
HK 高周波積層チップインダクタ	0603 (0201) 0.6×0.3 1005 (0402) 1.0×0.5 1608 (0603) 1.6×0.8 2125 (0805) 2.0×1.2	例 3N9 3.9 10N 10 R10 100 R12 120 ※R=小数点 ※N=nHとしての小数点	H ± 3% J ± 5% C ±0.2nH S ±0.3nH	-T リールテーピング

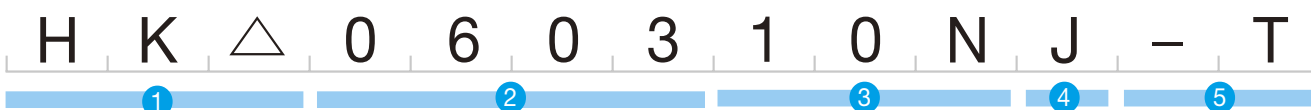

1	2	3	4	5
Type	External Dimensions [mm]	Nominal Inductance [nH]	Inductance Tolerances	Packaging
HK Multilayer chip inductors for high frequency	0603 (0201) 0.6×0.3 1005 (0402) 1.0×0.5 1608 (0603) 1.6×0.8 2125 (0805) 2.0×1.2	Example 3N9 3.9 10N 10 R10 100 R12 120 *R=decimal point *N=0.0 (nH type)	H ± 3% J ± 5% C ±0.2nH S ±0.3nH	-T Tape & Reel

外形寸法 EXTERNAL DIMENSIONS

HK Type

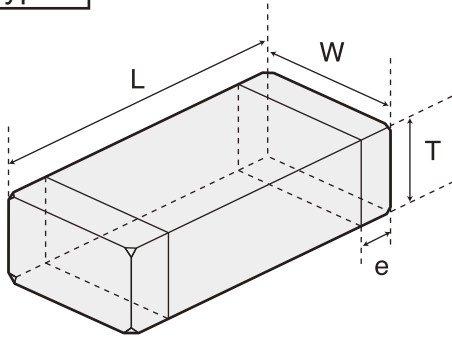

Type	L	W	T	e
HK0603 (0201)	0.6 ± 0.03 (0.024 ± 0.001)	0.3 ± 0.03 (0.012 ± 0.001)	0.3 ± 0.03 (0.012 ± 0.001)	0.15 ± 0.05 (0.006 ± 0.002)
HK1005 (0402)	1.00 ± 0.05 (0.039 ± 0.002)	0.5 ± 0.05 (0.020 ± 0.002)	0.5 ± 0.05 (0.020 ± 0.002)	0.25 ± 0.10 (0.010 ± 0.004)
HK1608 (0603)	1.6 ± 0.15 (0.063 ± 0.006)	0.8 ± 0.15 (0.031 ± 0.006)	0.8 ± 0.15 (0.031 ± 0.006)	0.3 ± 0.2 (0.012 ± 0.008)
HK2125 (0805)	2.0 + 0.3 - 0.1 (0.079 + 0.012 - 0.004)	1.25 ± 0.2 (0.049 ± 0.008)	0.85 ± 0.2 1.0 ± 0.3 (0.033 ± 0.008) (0.039 ± 0.008)	0.5 ± 0.3 (0.020 ± 0.012)

Unit : mm (inch)

概略バリエーション AVAILABLE INDUCTANCE RANGE

Range	Type	HK0603	HK1005	HK1608	HK2125
inductance [nH]		使用温度範囲 -55~+125°C Imax [mA]	使用温度範囲 -55~+125°C -55~+85°C Imax [mA] Imax [mA]	使用温度範囲 -40~+85°C Imax [mA]	使用温度範囲 -40~+85°C Imax [mA]
	1.0	1N0□ 470	1N0□ 900	1N0□ 900	
	1.2	1N2□ 450	1N2□ 900	1N2□ 900	
	1.5	1N5□ 430	1N5□ 850	1N5□ 850	
	1.8	1N8□ 390	1N8□ 700	1N8□ 700	
	2.2	2N2□ 360	2N2□ 700	2N2□ 700	
	2.7	2N7□ 340	2N7□ 650	2N7□ 650	
	3.3	3N3□ 320	3N3□ 550	3N3□ 550	
	3.9	3N9□ 300	3N9□ 500	3N9□ 500	
	4.7	4N7□ 280	4N7□ 500	4N7□ 500	
	5.6	5N6□ 260	5N6□ 430	5N6□ 430	
	6.8	6N8□ 250	6N8□ 430	6N8□ 430	
	8.2	8N2○ 230	8N2○ 380	8N2○ 380	
	10.0	10N○ 220	10N○ 340	10N○ 340	
	12.0	12N○ 190	12N○ 330	12N○ 330	
	15.0	15N○ 180	15N○ 320	15N○ 320	
	18.0	18N○ 170	18N○ 310	18N○ 310	
	22.0	22N○ 150	22N○ 300	22N○ 300	
	27.0	27N○ 120	27N○ 300	27N○ 300	
	33.0	33N○ 110	33N○ 250	33N○ 250	
	39.0	39N○ 100	39N○ 250	39N○ 250	
	47.0	47N○ 100	47N○ 230	47N○ 230	
	56.0	56N○ 80	56N○ 220	56N○ 220	
	68.0	68N○ 80	68N○ 180	68N○ 180	
82.0	82N○ 70	82N○ 180	82N○ 180		
100.0	R10○ 60	R10○ 150	R10○ 150		
120.0		R12○ 140	R12○ 140		
150.0		R15○ 140	R15○ 140		
180.0		R18○ 130	R18○ 130		
220.0		R22○ 120	R22○ 120		
270.0		R27○ 110	R27○ 110		
330.0			R33○ 150		
390.0			R39○ 150		
470.0			R47○ 150		

代表値 Examples	Inductance	Imax [mA]	Rdcmax [Ω]	Imax [mA]		Rdcmax [Ω]	Imax [mA]	Rdcmax [Ω]	Imax [mA]	Rdcmax [Ω]
				-55~+125°C	-55~+85°C					
	1.5nH	430	0.13	300	850	0.1	300	0.1	300	0.1
	10.0nH	220	0.51	300	340	0.31	300	0.26	300	0.3
	100.0nH	60	3.74	150	200	1.5	300	1	300	0.9

※形名の□、○にはインダクタンス許容差記号が入ります。±0.3nH (□)、±5% (○)以下の許容差も対応可能ですので、お問い合わせ下さい。
□、○mark indicates the Inductance tolerance code. The product with tolerance less than ±0.3nH (□), ±5% (○) is also available. Please contact your local sales office.

セレクションガイド
Selection Guide

アイテム一覧
Part Numbers

特性図
Electrical Characteristics

梱包
Packaging

信頼性
Reliability Data

使用上の注意
Precautions



etc

△当社カタログをご使用の際には「当社製品に関するお断り」を必ずお読みください。

TAIYO YUDEN 2009

△Please read the "Notice for TAIYO YUDEN products" before using this catalog.

アイテム一覧 PART NUMBERS

HK0603

形名 Ordering code	EHS (Environmental Hazardous Substances)	インダクタンス Inductance [nH]	Q min.	LQ測定周波数 Measuring frequency [MHz]	Q (Typical) 周波数 Frequency [MHz]					自己共振周波数 Self-resonant frequency [MHz]		直流抵抗 DC Resistance [Ω]		定格電流 Rated current [mA] max.	厚さ Thickness [mm] (inch)
					100	300	500	800	1000	min.	Typ.	max.	Typ.		
HK 0603 1N0□	RoHS	1.0±0.3nH ※	4	100	6	12	17	22	27	10000	>13000	0.11	0.088	470	0.30±0.03 (0.012±0.001)
HK 0603 1N2□	RoHS	1.2±0.3nH ※	4	100	6	12	16	21	25	10000	>13000	0.12	0.089	450	
HK 0603 1N5□	RoHS	1.5±0.3nH ※	4	100	6	12	15	20	23	10000	>13000	0.13	0.11	430	
HK 0603 1N8□	RoHS	1.8±0.3nH ※	4	100	6	12	15	20	23	10000	>13000	0.16	0.12	390	
HK 0603 2N0□	RoHS	2.0±0.3nH ※	4	100	6	12	15	20	22	10000	>13000	0.17	0.13	380	
HK 0603 2N2□	RoHS	2.2±0.3nH ※	4	100	6	12	15	20	22	8800	12500	0.19	0.14	360	
HK 0603 2N4□	RoHS	2.4±0.3nH ※	4	100	6	12	15	20	22	8300	11700	0.20	0.15	350	
HK 0603 2N7□	RoHS	2.7±0.3nH ※	5	100	7	12	15	20	22	7700	11000	0.21	0.16	340	
HK 0603 3N0□	RoHS	3.0±0.3nH ※	5	100	7	12	15	20	22	7200	11000	0.22	0.18	330	
HK 0603 3N3□	RoHS	3.3±0.3nH ※	5	100	7	12	15	20	22	6700	9600	0.23	0.19	320	
HK 0603 3N6□	RoHS	3.6±0.3nH ※	5	100	7	12	15	20	22	6400	9100	0.25	0.20	310	
HK 0603 3N9□	RoHS	3.9±0.3nH ※	5	100	7	12	15	20	22	6000	8600	0.27	0.20	300	
HK 0603 4N3□	RoHS	4.3±0.3nH ※	5	100	7	12	15	19	21	5700	8100	0.30	0.22	280	
HK 0603 4N7□	RoHS	4.7±0.3nH ※	5	100	7	12	15	19	21	5300	7600	0.30	0.24	280	
HK 0603 5N1□	RoHS	5.1±0.3nH ※	5	100	7	12	15	19	21	5000	7100	0.33	0.26	270	
HK 0603 5N6□	RoHS	5.6±0.3nH ※	5	100	7	12	15	19	21	4600	6600	0.36	0.27	260	
HK 0603 6N2□	RoHS	6.2±0.3nH ※	5	100	7	11	14	18	20	4200	6100	0.38	0.29	250	
HK 0603 6N8○	RoHS	6.8±5% ※	5	100	7	11	14	18	20	3900	5600	0.39	0.30	250	
HK 0603 7N5○	RoHS	7.5±5% ※	5	100	7	11	14	18	19	3600	5300	0.41	0.34	240	
HK 0603 8N2○	RoHS	8.2±5% ※	5	100	7	11	14	18	19	3400	4900	0.45	0.34	230	
HK 0603 9N1○	RoHS	9.1±5% ※	5	100	7	11	14	17	18	3200	4600	0.48	0.40	220	
HK 0603 10N○	RoHS	10±5% ※	5	100	7	11	14	17	18	2900	4200	0.51	0.41	220	
HK 0603 12N○	RoHS	12±5% ※	5	100	7	11	14	17	18	2700	3800	0.68	0.45	190	
HK 0603 15N○	RoHS	15±5% ※	5	100	7	11	13	16	17	2300	3300	0.71	0.5	180	
HK 0603 18N○	RoHS	18±5% ※	5	100	7	11	13	16	17	2100	3000	0.81	0.57	170	
HK 0603 22N○	RoHS	22±5% ※	5	100	7	11	13	15	16	1800	2600	1	0.71	150	
HK 0603 27N○	RoHS	27±5% ※	4	100	6	10	12	14	15	1800	2600	1.35	1.11	120	
HK 0603 33N○	RoHS	33±5% ※	4	100	6	10	12	14	14	1700	2400	1.47	1.33	110	
HK 0603 39N○	RoHS	39±5% ※	4	100	6	10	12	13	12	1500	2100	1.72	1.51	100	
HK 0603 47N○	RoHS	47±5% ※	4	100	6	10	11	12	11	1300	1800	1.90	1.74	100	
HK 0603 56N○	RoHS	56±5% ※	4	100	6	10	11	11	10	1100	1600	2.27	1.85	80	
HK 0603 68N○	RoHS	68±5% ※	4	100	6	10	11	11	10	1100	1500	2.66	2.30	80	
HK 0603 82N○	RoHS	82±5% ※	4	100	6	10	11	10	8	1000	1400	3.37	2.60	70	
HK 0603 R10○	RoHS	100±5% ※	4	100	6	9	10	9	6	900	1200	3.74	3.00	60	

※形名の□、○にはインダクタンス許容差記号が入ります。±0.3nH (□)、±5% (○)以下の許容差も対応可能ですので、お問い合わせ下さい。

□、○mark indicates the Inductance tolerance code. The product with tolerance less than ±0.3nH (□), ±5% (○) is also available. Please contact your local sales office.

HK1005

形名 Ordering code	EHS (Environmental Hazardous Substances)	インダクタンス Inductance [nH]	Q min.	LQ測定周波数 Measuring frequency [MHz]	Q (Typical) 周波数 Frequency [MHz]					自己共振周波数 Self-resonant frequency [MHz]		直流抵抗 DC Resistance [Ω]		定格電流 Rated current [mA] max.	厚さ Thickness [mm] (inch)
					100	300	500	800	1000	min.	Typ.	max.	Typ.		
HK 1005 1N0□	RoHS	1.0±0.3nH ※	8	100	11	25	34	43	52	10000	>13000	0.08	0.04	300	0.50±0.05 (0.020±0.002)
HK 1005 1N2□	RoHS	1.2±0.3nH ※	8	100	11	25	35	44	52	10000	>13000	0.09	0.04	300	
HK 1005 1N5□	RoHS	1.5±0.3nH ※	8	100	11	24	33	44	48	6000	>13000	0.1	0.05	300	
HK 1005 1N8□	RoHS	1.8±0.3nH ※	8	100	11	23	30	36	42	6000	11000	0.12	0.06	300	
HK 1005 2N0□	RoHS	2.0±0.3nH ※	8	100	11	21	27	34	39	6000	10500	0.12	0.06	300	
HK 1005 2N2□	RoHS	2.2±0.3nH ※	8	100	10	18	25	31	36	6000	10000	0.13	0.07	300	
HK 1005 2N4□	RoHS	2.4±0.3nH ※	8	100	10	18	24	31	35	6000	9500	0.13	0.07	300	
HK 1005 2N7□	RoHS	2.7±0.3nH ※	8	100	10	18	24	31	34	6000	9000	0.13	0.08	300	
HK 1005 3N0□	RoHS	3.0±0.3nH ※	8	100	10	18	24	31	35	6000	8500	0.16	0.09	300	
HK 1005 3N3□	RoHS	3.3±0.3nH ※	8	100	10	18	24	31	35	6000	8000	0.16	0.1	300	
HK 1005 3N6□	RoHS	3.6±0.3nH ※	8	100	10	18	24	31	35	5000	7500	0.2	0.11	300	
HK 1005 3N9□	RoHS	3.9±0.3nH ※	8	100	10	18	24	31	35	4000	7000	0.21	0.12	300	
HK 1005 4N3□	RoHS	4.3±0.3nH ※	8	100	10	18	24	31	35	4000	6500	0.2	0.12	300	
HK 1005 4N7□	RoHS	4.7±0.3nH ※	8	100	10	18	24	31	34	4000	6000	0.21	0.12	300	
HK 1005 5N1□	RoHS	5.1±0.3nH ※	8	100	10	18	24	31	34	4000	5800	0.21	0.13	300	
HK 1005 5N6□	RoHS	5.6±0.3nH ※	8	100	10	18	24	30	35	4000	5700	0.23	0.15	300	
HK 1005 6N2□	RoHS	6.2±0.3nH ※	8	100	10	18	24	30	34	3900	5600	0.25	0.16	300	
HK 1005 6N8○	RoHS	6.8±5% ※	8	100	10	18	23	29	32	3900	5500	0.25	0.17	300	
HK 1005 7N5○	RoHS	7.5±5% ※	8	100	10	18	23	29	32	3700	5200	0.25	0.18	300	
HK 1005 8N2○	RoHS	8.2±5% ※	8	100	10	18	23	29	31	3600	4900	0.28	0.21	300	
HK 1005 9N1○	RoHS	9.1±5% ※	8	100	10	18	23	29	31	3400	4500	0.3	0.22	300	
HK 1005 10N○	RoHS	10±5% ※	8	100	10	18	23	29	31	3200	4300	0.31	0.23	300	
HK 1005 12N○	RoHS	12±5% ※	8	100	11	18	23	29	31	2700	3900	0.4	0.28	300	
HK 1005 15N○	RoHS	15±5% ※	8	100	11	18	23	28	30	2300	3500	0.46	0.31	300	
HK 1005 18N○	RoHS	18±5% ※	8	100	11	18	23	28	30	2100	3100	0.55	0.35	300	
HK 1005 22N○	RoHS	22±5% ※	8	100	11	17	22	26	27	1900	2800	0.6	0.42	300	
HK 1005 27N○	RoHS	27±5% ※	8	100	11	17	21	25	26	1600	2300	0.7	0.47	300	
HK 1005 33N○	RoHS	33±5% ※	8	100	11	16	20	23	22	1300	1900	0.8	0.5	200	
HK 1005 39N○	RoHS	39±5% ※	8	100	11	16	20	23	21	1200	1700	0.9	0.52	200	
HK 1005 47N○	RoHS	47±5% ※	8	100	11	16	19	21	18	1000	1500	1	0.58	200	
HK 1005 56N○	RoHS	56±5% ※	8	100	11	16	18	18	16	750	1300	1	0.61	200	
HK 1005 68N○	RoHS	68±5% ※	8	100	11	15	17	18	11	750	1200	1.2	0.7	180	
HK 1005 82N○	RoHS	82±5% ※	8	100	10	14	16	15	6	600	1100	1.3	0.81	150	
HK 1005 R10○	RoHS	100±5% ※	8	100	10	14	14	12	—	600	1000	1.5	0.94	150	
HK 1005 R12○	RoHS	120±5% ※	8	100	10	12	10	—	—	600	800	1.6	1.1	150	
HK 1005 R15○	RoHS	150±5% ※	8	100	12	17	17	—	—	550	920	3.2	2.57	140	
HK 1005 R18○	RoHS	180±5% ※	8	100	12	16	—	—	—	500	810	3.7	2.97	130	
HK 1005 R22○	RoHS	220±5% ※	8	100	12	16	—	—	—	450	700	4.2	3.29	120	
HK 1005 R27○	RoHS	270±5% ※	8	100	12	14	—	—	—	400	600	4.8	3.92	110	

※形名の□、○にはインダクタンス許容差記号が入ります。±0.3nH (□)、±5% (○)以下の許容差も対応可能ですので、お問い合わせ下さい。

□、○mark indicates the Inductance tolerance code. The product with tolerance less than ±0.3nH (□), ±5% (○) is also available. Please contact your local sales office.

HK1608

形名 Ordering code	EHS (Environmental Hazardous Substances)	インダクタンス Inductance [nH]	Q min.	LQ測定周波数 Measuring frequency [MHz]	Q (Typical) 周波数 Frequency [MHz]					自己共振周波数 Self-resonant frequency [MHz]		直流抵抗 DC Resistance [Ω]		定格電流 Rated current [mA] max.	厚さ Thickness [mm] (inch)
					100	300	500	800	1000	min.	Typ.	max.	Typ.		
					min.		Typ.		max.						
HK 1608 1N0□	RoHS	1.0±0.3nH ※	8	100	14	30	40	70	90	10000	>13000	0.05	0.015	300	0.8±0.15 (0.031±0.006)
HK 1608 1N2□	RoHS	1.2±0.3nH ※	8	100	14	30	40	70	90	10000	>13000	0.05	0.015	300	
HK 1608 1N5□	RoHS	1.5±0.3nH ※	8	100	14	26	34	47	50	6000	>13000	0.10	0.03	300	
HK 1608 1N8□	RoHS	1.8±0.3nH ※	8	100	10	18	24	30	34	6000	>13000	0.10	0.06	300	
HK 1608 2N2□	RoHS	2.2±0.3nH ※	8	100	12	22	29	37	40	6000	12000	0.10	0.06	300	
HK 1608 2N7□	RoHS	2.7±0.3nH ※	10	100	13	24	32	41	45	6000	11000	0.10	0.06	300	
HK 1608 3N3□	RoHS	3.3±0.3nH ※	10	100	14	25	33	42	47	6000	9000	0.12	0.06	300	
HK 1608 3N9□	RoHS	3.9±0.3nH ※	10	100	13	25	33	42	46	6000	8000	0.14	0.07	300	
HK 1608 4N7□	RoHS	4.7±0.3nH ※	10	100	13	25	33	42	47	4000	6500	0.16	0.08	300	
HK 1608 5N6□	RoHS	5.6±0.3nH ※	10	100	14	25	33	42	46	4000	5800	0.18	0.09	300	
HK 1608 6N8○	RoHS	6.8±5% ※	10	100	14	25	33	43	47	4000	5600	0.22	0.11	300	
HK 1608 8N2○	RoHS	8.2±5% ※	10	100	14	26	34	44	48	3500	5200	0.24	0.13	300	
HK 1608 10N○	RoHS	10±5% ※	12	100	14	26	34	43	47	3400	4600	0.26	0.16	300	
HK 1608 12N○	RoHS	12±5% ※	12	100	14	27	35	45	49	2600	4000	0.28	0.17	300	
HK 1608 15N○	RoHS	15±5% ※	12	100	15	28	37	46	51	2300	3400	0.32	0.20	300	
HK 1608 18N○	RoHS	18±5% ※	12	100	15	27	36	44	48	2000	3000	0.35	0.21	300	
HK 1608 22N○	RoHS	22±5% ※	12	100	16	28	36	44	47	1600	2900	0.40	0.25	300	
HK 1608 27N○	RoHS	27±5% ※	12	100	16	29	37	45	46	1400	2200	0.45	0.28	300	
HK 1608 33N○	RoHS	33±5% ※	12	100	17	31	40	46	47	1200	1800	0.55	0.35	300	
HK 1608 39N○	RoHS	39±5% ※	12	100	18	31	39	44	44	1100	1600	0.60	0.38	300	
HK 1608 47N○	RoHS	47±5% ※	12	100	17	28	34	35	34	900	1600	0.70	0.45	300	
HK 1608 56N○	RoHS	56±5% ※	12	100	17	28	34	34	31	900	1400	0.75	0.50	300	
HK 1608 68N○	RoHS	68±5% ※	12	100	18	29	34	30	22	700	1200	0.85	0.55	300	
HK 1608 82N○	RoHS	82±5% ※	12	100	18	28	33	27	—	600	1100	0.95	0.60	300	
HK 1608 R10○	RoHS	100±5% ※	12	100	18	27	28	16	—	600	1000	1.00	0.65	300	
HK 1608 R12○	RoHS	120±5% ※	8	50	16	24	23	—	—	500	800	1.20	0.68	300	
HK 1608 R15○	RoHS	150±5% ※	8	50	13	19	16	—	—	500	800	1.20	0.73	300	
HK 1608 R18○	RoHS	180±5% ※	8	50	13	18	12	—	—	400	700	1.30	0.85	300	
HK 1608 R22○	RoHS	220±5% ※	8	50	12	16	—	—	—	400	600	1.50	0.95	300	
HK 1608 R27○	RoHS	270±5% ※	8	50	14	15	—	—	—	400	550	1.9	1.34	150	
HK 1608 R33○	RoHS	330±5% ※	8	50	14	—	—	—	—	350	480	2.1	1.53	150	
HK 1608 R39○	RoHS	390±5% ※	8	50	13	—	—	—	—	350	410	2.3	1.72	150	
HK 1608 R47○	RoHS	470±5% ※	8	50	13	—	—	—	—	300	360	2.6	2.04	150	

※形名の□、○にはインダクタンス許容差記号が入ります。±0.3nH (□)、±5% (○)以下の許容差も対応可能ですので、お問い合わせ下さい。

□, ○ mark indicates the inductance tolerance code. The product with tolerance less than ±0.3nH (□), ±5% (○) is also available. Please contact your local sales office.

HK2125

形名 Ordering code	EHS (Environmental Hazardous Substances)	インダクタンス Inductance [nH]	Q min.	LQ測定周波数 Measuring frequency [MHz]	Q (Typical) 周波数 Frequency [MHz]					自己共振周波数 Self-resonant Frequency [MHz]		直流抵抗 DC Resistance [Ω]		定格電流 Rated current [mA]	厚さ Thickness [mm] (inch)
					100	300	500	800	1000	min.	Typ.	max.	Typ.		
					min.		Typ.		max.						
HK 2125 1N5S	RoHS	1.5±0.3nH	10	100	21	39	57	61	68	4000	>6000	0.10	0.02	300	0.85±0.2 (0.033±0.008)
HK 2125 1N8S	RoHS	1.8±0.3nH	10	100	18	35	49	55	59	4000	>6000	0.10	0.02	300	
HK 2125 2N2S	RoHS	2.2±0.3nH	10	100	18	33	46	53	58	4000	>6000	0.10	0.03	300	
HK 2125 2N7S	RoHS	2.7±0.3nH	12	100	19	36	50	56	60	4000	>6000	0.10	0.03	300	
HK 2125 3N3S	RoHS	3.3±0.3nH	12	100	16	29	40	47	51	4000	>6000	0.13	0.04	300	
HK 2125 3N9S	RoHS	3.9±0.3nH	12	100	18	33	46	54	60	4000	>6000	0.15	0.05	300	
HK 2125 4N7S	RoHS	4.7±0.3nH	12	100	18	34	46	55	60	3500	>6000	0.20	0.05	300	
HK 2125 5N6S	RoHS	5.6±0.3nH	15	100	20	38	51	60	66	3200	5400	0.23	0.05	300	
HK 2125 6N8J	RoHS	6.8±5% ※	15	100	20	39	52	63	69	2800	4200	0.25	0.06	300	
HK 2125 8N2J	RoHS	8.2±5% ※	15	100	21	40	54	63	70	2400	3700	0.28	0.07	300	
HK 2125 10NJ	RoHS	10±5% ※	15	100	20	38	51	60	67	2100	3100	0.30	0.09	300	
HK 2125 12NJ	RoHS	12±5% ※	15	100	21	39	52	60	67	1900	3000	0.35	0.10	300	
HK 2125 15NJ	RoHS	15±5% ※	15	100	22	42	55	63	72	1600	2600	0.40	0.11	300	
HK 2125 18NJ	RoHS	18±5% ※	15	100	24	44	57	63	72	1500	2300	0.45	0.13	300	
HK 2125 22NJ	RoHS	22±5% ※	18	100	23	43	55	60	69	1400	2100	0.50	0.16	300	
HK 2125 27NJ	RoHS	27±5% ※	18	100	23	42	53	58	68	1300	1800	0.55	0.17	300	
HK 2125 33NJ	RoHS	33±5% ※	18	100	24	43	54	55	60	1200	1700	0.60	0.19	300	
HK 2125 39NJ	RoHS	39±5% ※	18	100	23	41	50	47	47	1000	1400	0.65	0.25	300	
HK 2125 47NJ	RoHS	47±5% ※	18	100	23	41	49	43	41	900	1200	0.70	0.26	300	
HK 2125 56NJ	RoHS	56±5% ※	18	100	23	42	48	39	38	800	1100	0.75	0.28	300	
HK 2125 68NJ	RoHS	68±5% ※	18	100	25	42	45	30	—	700	900	0.80	0.33	300	
HK 2125 82NJ	RoHS	82±5% ※	18	100	24	41	41	—	—	600	800	0.90	0.37	300	
HK 2125 R10J	RoHS	100±5% ※	18	100	23	37	37	—	—	600	800	0.90	0.40	300	
HK 2125 R12J	RoHS	120±5% ※	13	50	22	33	29	—	—	500	700	0.95	0.43	300	
HK 2125 R15J	RoHS	150±5% ※	13	50	22	34	26	—	—	500	700	1.00	0.46	300	
HK 2125 R18J	RoHS	180±5% ※	13	50	23	34	20	—	—	400	600	1.10	0.50	300	
HK 2125 R22J	RoHS	220±5% ※	12	50	20	23	—	—	—	350	550	1.20	0.75	300	
HK 2125 R27J	RoHS	270±5% ※	12	50	20	19	—	—	—	300	480	1.30	0.85	300	
HK 2125 R33J	RoHS	330±5% ※	12	50	22	15	—	—	—	250	400	1.40	0.90	300	
HK 2125 R39J	RoHS	390±5% ※	10	50	17	12	—	—	—	250	400	1.30	0.85	300	
HK 2125 R47J	RoHS	470±5% ※	10	50	17	—	—	—	—	200	350	1.50	0.95	300	

Q-周波数特性例 Q-Characteristics (Measured by HP8719C)

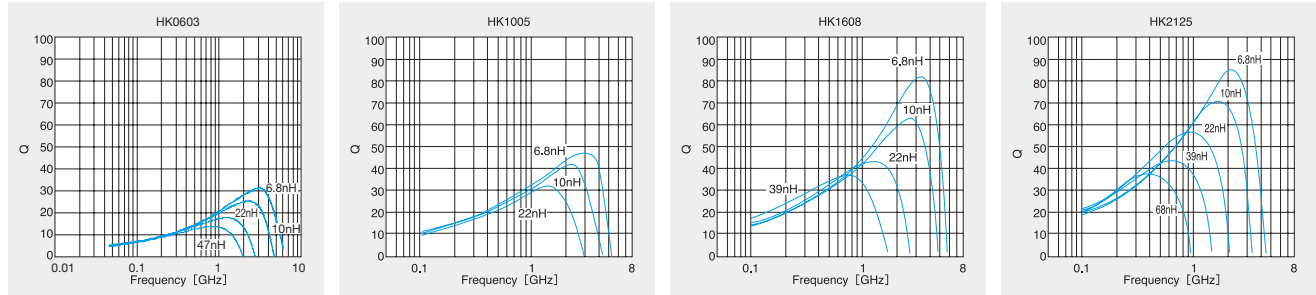

インピーダンス周波数特性例 Impedance-vs-Frequency characteristics (Measured by HP8719C)

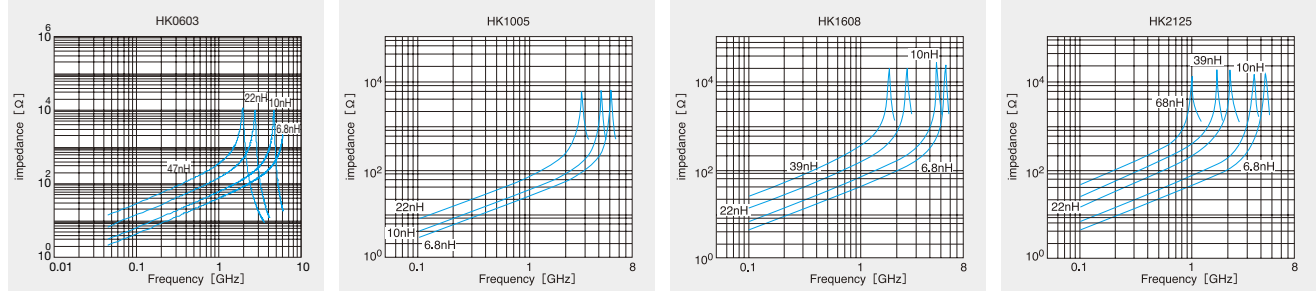

インダクタンス周波数特性例 Inductance-vs-Frequency characteristics (Measured by HP8719C)

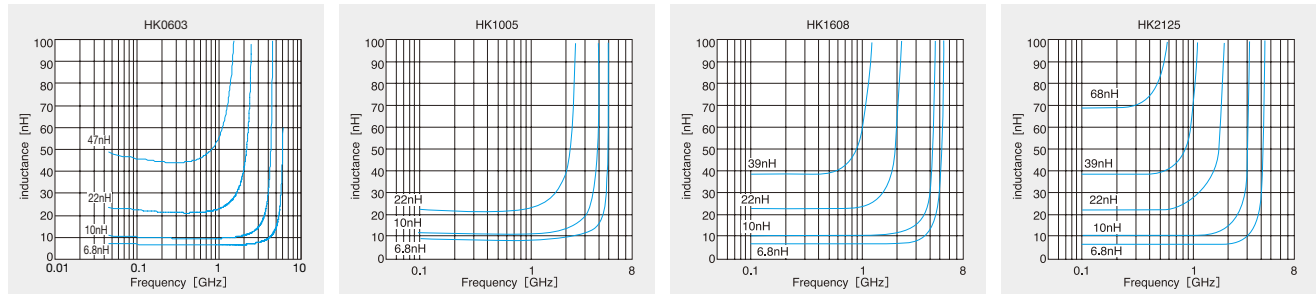

①最小受注単位数 Minimum Quantity
 ■テーピング梱包 Tape & Reel Packaging

形式 Type	製品厚み Thickness [mm] (inch)	標準数量 [pcs] Standard Quantity	
		紙テープ Paper Tape	エンボステープ Embossed Tape
CK1608(0603)	0.8 (0.031)	4000	—
CK2125(0805)	0.85 (0.033)	4000	—
	1.25 (0.049)	—	2000
CKP2520(1008)	0.9 (0.035)	—	3000
	1.1 (0.043)	—	2000
LK1005(0402)	0.5 (0.020)	10000	—
LK1608(0603)	0.8 (0.031)	4000	—
LK2125(0805)	0.85 (0.033)	4000	—
	1.25 (0.049)	—	2000
HK0603(0201)	0.3 (0.012)	15000	—
HK1005(0402)	0.5 (0.020)	10000	—
HK1608(0603)	0.8 (0.031)	4000	—
HK2125(0805)	0.85 (0.033)	—	4000
	1.0 (0.039)	—	3000
HKQ0603S(0201)	0.3 (0.012)	15000	—
AQ105(0402)	0.5 (0.020)	10000	—
BK0603(0201)	0.3 (0.012)	15000	—
BK1005(0402)	0.5 (0.020)	10000	—
BK1608(0603)	0.8 (0.031)	4000	—
BK2125(0805)	0.85 (0.033)	4000	—
	1.25 (0.049)	—	2000
BK2010(0804)	0.45 (0.018)	4000	—
BK3216(1206)	0.8 (0.031)	—	4000
BKP0603(0201)	0.3 (0.012)	15000	—
BKP1005(0402)	0.5 (0.020)	10000	—
BKP1608(0603)	0.8 (0.031)	4000	—
BKP2125(0805)	0.85 (0.033)	4000	—

②テーピング材質 Taping material

紙テープ

Card board carrier tape

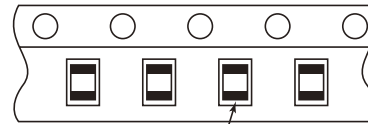
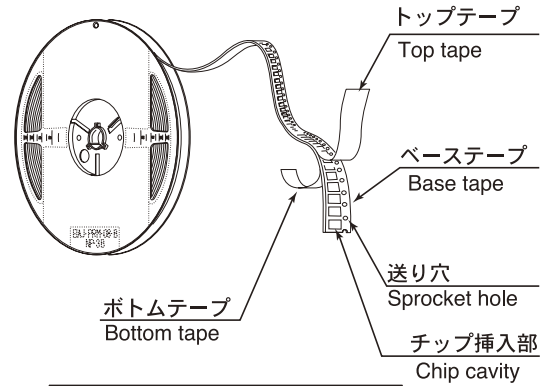

チップ詰状態
Chip filled

チップ
Chip

CK	1 6 0 8
CK	2 1 2 5
LK	1 0 0 5
LK	1 6 0 8
LK	2 1 2 5
HK	0 6 0 3
HK	1 0 0 5
HK	1 6 0 8
HK Q	0 6 0 3
AQ	1 0 5
BK	0 6 0 3
BK	1 0 0 5
BK	1 6 0 8
BK	2 1 2 5
BK	2 0 1 0
BK P	0 6 0 3
BK P	1 0 0 5
BK P	1 6 0 8
BK P	2 1 2 5

エンボステープ
Embossed Tape

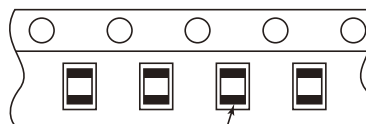
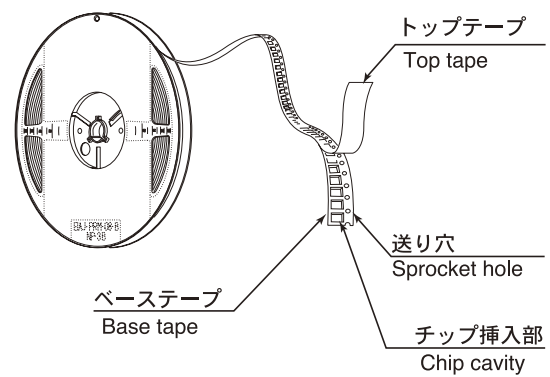

チップ詰状態
Chip filled

チップ
Chip

CK	2125
CKP	2520
LK	2125
HK	2125
BK	2125
BK	3216

③テーピング寸法 Taping Dimensions

・紙テープ (8mm幅) Paper tape (0.315 inches wide)

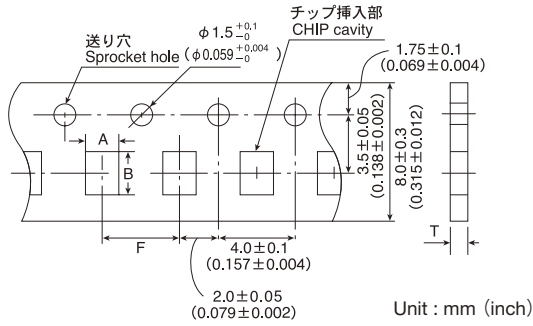

形式 Type	製品厚み Thickness (mm) (inch)	チップ挿入部 Chip cavity		挿入ピッチ Insertion Pitch F	テープ厚み Tape Thickness T	
		A	B		T	
CK1608(0603)	0.8 (0.031)	1.0±0.2 (0.039±0.008)	1.8±0.2 (0.071±0.008)	4.0±0.1 (0.157±0.004)	1.1max (0.043max)	
CK2125(0805)	0.85 (0.033)	1.5±0.2 (0.059±0.008)	2.3±0.2 (0.091±0.008)	4.0±0.1 (0.157±0.004)	1.1max (0.043max)	
LK1005(0402)	0.5 (0.020)	0.65±0.1 (0.026±0.004)	1.15±0.1 (0.045±0.004)	2.0±0.05 (0.079±0.002)	0.8max (0.031max)	
LK1608(0603)	0.8 (0.031)	1.0±0.2 (0.039±0.008)	1.8±0.2 (0.071±0.008)	4.0±0.1 (0.157±0.004)	1.1max (0.043max)	
LK2125(0805)	0.85 (0.033)	1.5±0.2 (0.059±0.008)	2.3±0.2 (0.091±0.008)	4.0±0.1 (0.157±0.004)	1.1max (0.043max)	
HK0603(0201)	0.3 (0.012)	0.40±0.06 (0.016±0.002)	0.70±0.06 (0.028±0.002)	2.0±0.05 (0.079±0.002)	0.45max (0.018max)	
HK1005(0402)	0.5 (0.020)	0.65±0.1 (0.026±0.004)	1.15±0.1 (0.045±0.004)	2.0±0.05 (0.079±0.002)	0.8max (0.031max)	
HK1608(0603)	0.8 (0.031)	1.0±0.2 (0.039±0.008)	1.8±0.2 (0.071±0.008)	4.0±0.1 (0.157±0.004)	1.1max (0.043max)	
HKQ0603S(0201)	0.3 (0.012)	0.40±0.06 (0.016±0.002)	0.70±0.06 (0.028±0.002)	2.0±0.05 (0.079±0.002)	0.45max (0.018max)	
AQ105(0402)	0.5 (0.020)	0.75±0.1 (0.030±0.004)	1.15±0.1 (0.045±0.004)	2.0±0.05 (0.079±0.002)	0.8max (0.031max)	
BK0603(0201)	0.3 (0.012)	0.40±0.06 (0.016±0.002)	0.70±0.06 (0.028±0.002)	2.0±0.05 (0.079±0.002)	0.45max (0.018max)	
BK1005(0402)	0.5 (0.020)	0.65±0.1 (0.026±0.004)	1.15±0.1 (0.045±0.004)	2.0±0.05 (0.079±0.002)	0.8max (0.031max)	
BK1608(0603)	0.8 (0.031)	1.0±0.2 (0.039±0.008)	1.8±0.2 (0.071±0.008)	4.0±0.1 (0.157±0.004)	1.1max (0.043max)	
BK2125(0805)	0.85 (0.033)	1.5±0.2 (0.059±0.008)	2.3±0.2 (0.091±0.008)	4.0±0.1 (0.157±0.004)	1.1max (0.043max)	
BK2010(0804)	0.45 (0.018)	1.2±0.1 (0.047±0.004)	2.17±0.1 (0.085±0.004)	4.0±0.1 (0.157±0.004)	0.8max (0.031max)	
BKP0603(0201)	0.3 (0.012)	0.40±0.06 (0.016±0.002)	0.70±0.06 (0.028±0.002)	2.0±0.05 (0.079±0.002)	0.45max (0.018max)	
BKP1005(0402)	0.5 (0.020)	0.65±0.1 (0.026±0.004)	1.15±0.1 (0.045±0.004)	2.0±0.05 (0.079±0.002)	0.8max (0.031max)	
BKP1608(0603)	0.8 (0.031)	1.0±0.2 (0.039±0.008)	1.8±0.2 (0.071±0.008)	4.0±0.1 (0.157±0.004)	1.1max (0.043max)	
BKP2125(0805)	0.85 (0.033)	1.5±0.2 (0.059±0.008)	2.3±0.2 (0.091±0.008)	4.0±0.1 (0.157±0.004)	1.1max (0.043max)	

・エンボステープ (8mm幅) Embossed Tape (0.312 inches wide)

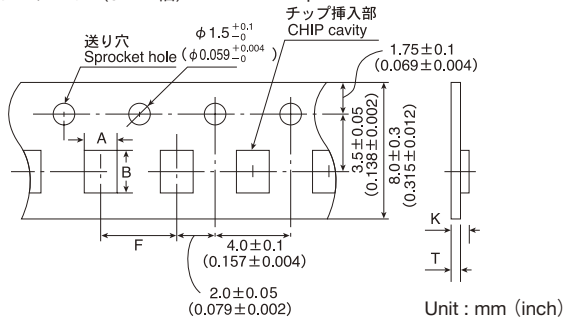

形式 Type	製品厚み Thickness (mm) (inch)	チップ挿入部 Chip cavity		挿入ピッチ Insertion Pitch F	テープ厚み Tape Thickness	
		A	B		K	T
CK2125(0805)	1.25 (0.049)	1.5±0.2 (0.059±0.008)	2.3±0.2 (0.091±0.008)	4.0±0.1 (0.157±0.004)	2.0 (0.079)	0.3 (0.012)
CKP2520(1008)	0.9 (0.035)	2.3±0.1 (0.091±0.004)	2.8±0.1 (0.110±0.004)	4.0±0.1 (0.157±0.004)	1.4 (0.055)	0.3 (0.012)
	1.1 (0.043)				1.7 (0.067)	
LK2125(0805)	1.25 (0.049)	1.5±0.2 (0.059±0.008)	2.3±0.2 (0.091±0.008)	4.0±0.1 (0.157±0.004)	2.0 (0.079)	0.3 (0.012)
HK2125(0805)	0.85 (0.033)	1.5±0.2 (0.059±0.008)	2.3±0.2 (0.091±0.008)	4.0±0.1 (0.157±0.004)	1.5 (0.059)	0.3 (0.012)
	1.0 (0.039)				2.0 (0.079)	
BK2125(0805)	1.25 (0.049)	1.5±0.2 (0.059±0.008)	2.3±0.2 (0.091±0.008)	4.0±0.1 (0.157±0.004)	2.0 (0.079)	0.3 (0.012)
BK3216(1206)	0.8 (0.031)	1.9±0.1 (0.075±0.004)	3.5±0.1 (0.138±0.004)	4.0±0.1 (0.157±0.004)	1.4 (0.055)	0.3 (0.012)

④リーダー部・空部 LEADER AND BLANK PORTION

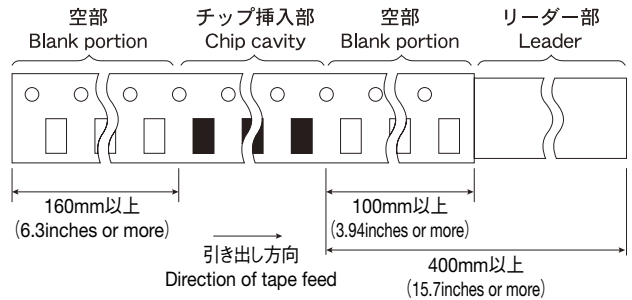

⑤リール寸法 Reel Size

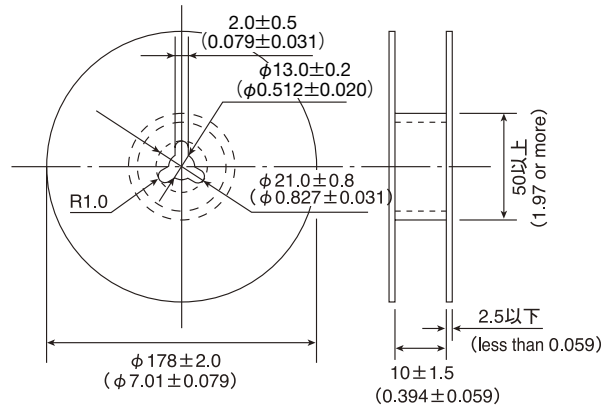

⑥トップテープ強度 Top tape strength

トップテープの剥離力は、下図矢印方向にて0.1~0.7Nとなります。The top tape requires a peel-off force of 0.1~0.7N in the direction of the arrow as illustrated below.

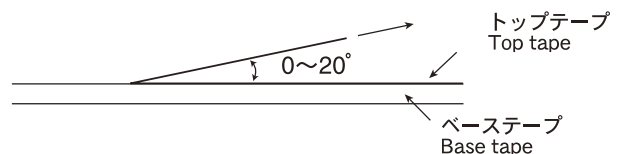

Multilayer chip inductors and beads

Item	Specified Value																				Test Methods and Remarks				
	BK0603	BK1005	BK1608	BK2125	ARRAY		BKP0603	BKP1005	BKP1608	BKP2125	CK1608	CK2125	CKP2520	LK1005	LK1608	LK2125	HK0603	HK1005	HK1608	HK2125		HKQ0603S	AQ105		
						BK2010	BK3216																		
1. Operating Temperature Range	-55~+125°C				-55~+85°C				-40~+85°C				-55~+125°C				-40~+85°C				-55~+125°C				
2. Storage Temperature Range	-55~+125°C				-55~+85°C				-40~+85°C				-55~+125°C				-40~+85°C				-55~+125°C				
3. Rated Current	100~500mA DC	150~1000mA DC	150~1500mA DC	200~1200mA DC	100mA DC	100~200mA DC	1.0A DC	1.0A DC	1.0~3.0A DC	2.0~4.0A DC	50~60mA DC	60~500mA DC	1.1~1.4 DC	10~25mA DC	1~50mA DC	5~300mA DC	60~470mA DC	110~300mA DC	150~300mA DC	300mA DC	130~600mA DC	280~710mA DC			
4. Impedance	10~600Ω ±25%	10~1000Ω ±25%	22~2500Ω ±25%	15~2500Ω ±25%	5~600Ω ±25%	68~1000Ω ±25%	22~33Ω ±25%	120Ω ±25%	33~390Ω ±25%	33~220Ω ±25%														BK0603 Series: BKP0603 Series: Measuring frequency: 100±1MHz Measuring equipment: HP4291A Measuring jig: 16193A BK1005 Series: BKP1005 Series: Measuring frequency: 100±1MHz Measuring equipment: HP4291A Measuring jig: 16192A, 16193A BK1608, 2125 Series: BKP1608, 2125 Series: Measuring frequency: 100±1MHz Measuring equipment: HP4291A, HP4195A Measuring jig: 16092A or 16192A (HW) BK2010, 3216 Series: Measuring frequency: 100±1MHz Measuring equipment: HP4291A, HP4195A Measuring jig: 16192A	
5. Impedance											4.7~10.0μH : ±20%	0.1~10.0μH : ±20%	1.0~4.7μH : ±10%	0.12~2.2μH : ±10%	0.047~33.0μH : ±20%	0.047~33.0μH : ±20%	1.0~6.2nH : ±0.3nH	1.0~6.2nH : ±0.3nH	1.0~5.6nH : ±0.3nH	1.0~5.6nH : ±0.3nH	1.0~6.2nH : ±0.3nH	1.0~6.2nH : ±0.3nH	0.6~6.2nH : ±5%	1.0~6.2nH : ±5%	CK Series: Measuring frequency: 2 to 4MHz (CK1608) Measuring frequency: 2 to 25MHz (CK2125) Measuring frequency: 1MHz (CKP2520) LK Series: Measuring frequency: 10 to 25MHz (LK1005) Measuring frequency: 1 to 50MHz (LK1608) Measuring frequency: 0.4 to 50MHz (LK2125) Measuring equipment, jig: HP4194 + 16085B + 16092A (or its equivalent) HP4195 + 41951 + 16092A (or its equivalent) HP4294 + 16192A HP4291A+16193A (LK1005) HP4285A+42841A+42842C+42851-61100 (CKP2520) Measuring current: 1mA rms (0.047 to 4.7μH) 0.1mA rms (5.6 to 33μH) HK, AQ Series : Measuring frequency: 100MHz (HK0603 · HK1005 · AQ105) Measuring frequency: 50/100MHz (HK1608 · HK2125) Measuring frequency: 500MHz (HKQ0603S) Measuring equipment, jig: HP4291A + 16197A (HK0603 · AQ105) HP4291A + 16193A (HK1005) E4991A + 16197A (HKQ0603S) HP4291A (or its equivalent) + 16092A + in-house made jig (HK1608, 2125)

* Definition of rated current : In the CK and BK Series, the rated current is the value of current at which the temperature of the element is increased within 20°C .
 In the BK Series P type and CK Series P type, the rated current is the value of current at which the temperature of the element is increased within 40°C .
 In the LK, HK, HKQ, and AQ Series, the rated current is either the DC value at which the internal L value is decreased within 5% with the application of DC bias, or the value of current at which the temperature of the element is increased within 20°C .

Multilayer chip inductors and beads

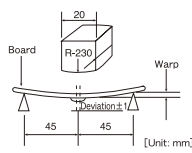
Item	Specified Value																				Test Methods and Remarks		
	BK0603	BK1005	BK1608	BK2125	ARRAY		BKP0603	BKP1005	BKP1608	BKP2125	CK1608	CK2125	CKP2520	LK1005	LK1608	LK2125	HK0603	HK1005	HK1608	HK2125		HKQ0603S	AQ105
					BK2010	BK3216																	
6. Q											20 min.	15~20 min.		10~20 min.	10~35 min.	15~50 min.	4~5 min.	8 min.	8~12 min.	10~18 min.	10~13 min.	8 min.	CK Series : Measuring frequency : 2 to 4MHz (CK1608) Measuring frequency : 2 to 25MHz (CK2125) LK Series : Measuring frequency : 10 to 25MHz (LK1005) Measuring frequency : 1 to 50MHz (LK1608) Measuring frequency : 0.4 to 50MHz (LK2125) Measuring equipment, jig : HP4194 + 16085B + 16092A (or its equivalent) · HP4195A + 41951 + 16092A (or its equivalent) · HP4294A + 16192A · HP4291A + 16193A (LK1005) Measuring current : · 1mA rms (0.047 to 4.7μH) · 0.1mA rms (5.6 to 33μH) HK, HKQ, AQ Series : Measuring frequency : 100MHz (HK0603 · HK1005 · AQ105) Measuring frequency : 50/100MHz (HK1608 · HK2125) Measuring frequency : 500MHz (HKQ0603S) Measuring equipment, jig : · HP4291A + 16197A (HK0603 · AQ105) · HP4291A + 16193A (HK1005) · E4991A + 16197A (HKQ0603S) · HP4294A + 16092A+ in-house made jig (HK1608 · HK2125)
7. DC Resistance	0.07~ 1.50Ω max.	0.05~ 0.80Ω max.	0.05~ 1.10Ω max.	0.05~ 0.75Ω max.	0.10~ 0.90Ω max.	0.15~ 0.80Ω max.	0.065~ 0.070Ω max.	0.140Ω max.	0.025~ 0.140Ω max.	0.020~ 0.050Ω max.	0.45~ 0.85Ω (±30%)	0.16~ 0.65Ω max.	0.08~ 0.15 max.	0.7~ 1.70Ω max.	0.2~ 2.2Ω max.	0.1~ 1.1Ω max.	0.11~ 3.74Ω max.	0.08~ 4.8Ω max.	0.05~ 2.6Ω max.	0.10~ 1.5Ω max.	0.06~ 1.29Ω max.	0.07~ 0.45Ω max.	Measuring equipment : VOAC-7412 (made by Iwasaki Tsushinki) VOAC-7512 (made by Iwasaki Tsushinki)
8. Self Resonance Frequency (SRF)											17~ 25MHz min.	24~ 235MHz min.		40~ 180MHz min.	9~ 260MHz min.	13~ 320MHz min.	900~ 1000MHz min.	400~ 1000MHz min.	300~ 1000MHz min.	200~ 400MHz min.	1900~ 1000MHz min.	2300~ 1000MHz min.	LK Series : Measuring equipment : HP4195A Measuring jig : 41951+16092A (or its equivalent) HK, HKQ, AQ Series : Measuring equipment : HP8719C HP8753D (HK2125)
9. Temperature Characteristic																							Inductance change : Within ±10% HK, HKQ, AQ Series : Temperature range : -30 to +85°C Reference temperature : +20°C
10. Resistance to Flexure of Substrate	No mechanical damage.																				Warp : 2mm Testing board : glass epoxy-resin substrate Thickness : 0.8mm 		

Multilayer chip inductors and beads

Item	Specified Value																			Test Methods and Remarks	
	BK0603	BK1005	BK1608	BK2125	ARRAY		BKP0603	BKP1005	BKP1608	BKP2125	CK1608	CK2125	CKP2520	LK1005	LK1608	LK2125	HK0603	HK1005	HK1608		HK2125
11. Solderability	At least 75% of terminal electrode is covered by new solder.										At least 75% of terminal electrode is covered by new solder.										Solder temperature : 230±5°C Duration : 4±1 sec.
12. Resistance to Soldering	Appearance : No significant abnormality. Impedance change : Within ±30%										No mechanical damage. Remaining terminal electrode : 70% min. Inductance change R10~4R7 : Within±10% 6R8~100 : Within±15% CKP2520 : Within±30%	No mechanical damage. Remaining terminal electrode : 70% min. Inductance change 47N~4R7 : Within±10% 5R6~330 : Within±15%	No mechanical damage. Remaining terminal electrode : 70% min. Inductance change Within ±5%	Solder temperature : 260±5°C Duration : 10±0.5 sec. Preheating temperature : 150 to 180°C Preheating time : 3 min. Flux : Immersion into methanol solution with colophony for 3 to 5 sec. Recovery : 2 to 3 hrs of recovery under the standard condition after the test. (See Note 1)							
13. Thermal Shock	Appearance : No significant abnormality. Impedance change : Within ±30%										No mechanical damage. Inductance change : Within ±20% Qchange : Within ±30%	No mechanical damage. Inductance change : Within ±10% Qchange : Within ±30%	No mechanical damage. Inductance change : Within ±10% Qchange : Within ±20%	Conditions for 1 cycle Step 1: Minimum operating temperature +0 ~ -3 °C 30±3 min. Step 2: Room temperature 2 to 3 min. Step 3: Maximum operating temperature +0 ~ -3 °C 30±3 min. Step 4: Room temperature 2 to 3 min. Number of cycles: 5 Recovery : 2 to 3 hrs of recovery under the standard condition after the test. (See Note 1)							

(Note 1) When there are questions concerning measurement result ; measurement shall be made after 48 ± 2 hrs of recovery under the standard condition.

Multilayer chip inductors and beads

Item	Specified Value																			Test Methods and Remarks			
	BK0603	BK1005	BK1608	BK2125	ARRAY		BKP0603	BKP1005	BKP1608	BKP2125	CK1608	CK2125	CKP2520	LK1005	LK1608	LK2125	HK0603	HK1005	HK1608		HK2125	HKQ0603S	AQ105
					BK2010	BK3216																	
14. Damp Heat (Steady state)	Appearance : No significant abnormality. Impedance change : Within $\pm 30\%$											No mechanical damage.	No mechanical damage.	No mechanical damage.	No mechanical damage.	No mechanical damage.	No mechanical damage.	No mechanical damage. Inductance change : Within $\pm 10\%$ Q change : Within $\pm 20\%$					BBK Series : Temperature : $40 \pm 2^\circ\text{C}$ Humidity : 90 to 95%RH Duration : $500 \begin{smallmatrix} +24 \\ -0 \end{smallmatrix}$ hrs Recovery : 2 to 3 hrs of recovery under the standard condition after the removal from test chamber. (See Note 1) LK, CK, CKP, HK, HKQ, AQ Series : Temperature : $40 \pm 2^\circ\text{C}$ (LK, CK, CKP Series) $60 \pm 2^\circ\text{C}$ (HK, HKQ, AQ Series) Humidity : 90 to 95%RH Duration : 500 ± 12 hrs Recovery : 2 to 3 hrs of recovery under the standard condition after the removal from test chamber. (See Note 1)
15. Loading under Damp Heat	Appearance : No significant abnormality. Impedance change : Within $\pm 30\%$											No mechanical damage.	No mechanical damage.	No mechanical damage.	No mechanical damage.	No mechanical damage.	No mechanical damage.	No mechanical damage. Inductance change : Within $\pm 10\%$ Q change : Within $\pm 20\%$					BK Series : Temperature : $40 \pm 2^\circ\text{C}$ Humidity : 90 to 95%RH Duration : $500 \begin{smallmatrix} +24 \\ -0 \end{smallmatrix}$ hrs Recovery : 2 to 3 hrs of recovery under the standard condition after the removal from test chamber. (See Note 1) LK, CK, CKP, HK, HKQ, AQ Series : Temperature : $40 \pm 2^\circ\text{C}$ (LK, CK, CKP Series) $60 \pm 2^\circ\text{C}$ (HK, HKQ, AQ Series) Humidity : 90 to 95%RH Duration : 500 ± 12 hrs Recovery : 2 to 3 hrs of recovery under the standard condition after the removal from test chamber. (See Note 1)
16. Loading at High Temperature	Appearance : No significant abnormality. Impedance change : Within $\pm 30\%$											No mechanical damage.	No mechanical damage.	No mechanical damage.	No mechanical damage.	No mechanical damage.	No mechanical damage.	No mechanical damage. Inductance change : Within $\pm 10\%$ Q change : Within $\pm 20\%$					BK Series : Temperature : $125 \pm 3^\circ\text{C}$ Applied current : Rated current Duration : $500 \begin{smallmatrix} +24 \\ -0 \end{smallmatrix}$ hrs Recovery : 2 to 3 hrs of recovery under the standard condition after the removal from test chamber. (See Note 1) LK, CK, CKP, HK, HKQ, AQ Series, BK Series P type : Temperature : $85 \pm 2^\circ\text{C}$ (LK, CK, CKP Series) $85 \pm 3^\circ\text{C}$ (BK Series P type) $85 \pm 2^\circ\text{C}$ (HK1608, 2125) $85 \pm 2^\circ\text{C}$ (HK1005, AQ105 operating temperature range -55 to +85°C) $125 \pm 2^\circ\text{C}$ (HK0603, HK1005, HKQ0603S, AQ105 operating temperature range -55 to +125°C) Applied current : Rated current Duration : 500 ± 12 hrs Recovery : 2 to 3 hrs of recovery under the standard condition after the test. (See Note 1)

Note on standard condition: "standard condition" referred to herein is defined as follows:
5 to 35°C of temperature, 45 to 85% relative humidity, and 86 to 106kPa of air pressure.

When there are questions concerning measurement results:

In order to provide correlation data, the test shall be conducted under condition of $20 \pm 2^\circ\text{C}$ of temperature, 60 to 70% relative humidity, and 86 to 106kPa of air pressure. Unless otherwise specified, all the tests are conducted under the "standard condition."

(Note 1)

measurement shall be made after 48 ± 2 hrs of recovery under the standard condition.

Precautions on the use of Multilayer chip Inductors, Multilayer chip inductors for high frequency, Multilayer ferrite chip beads

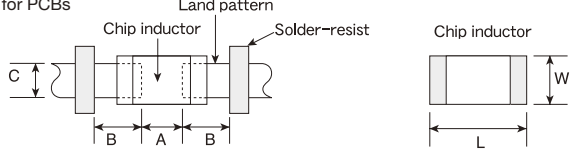
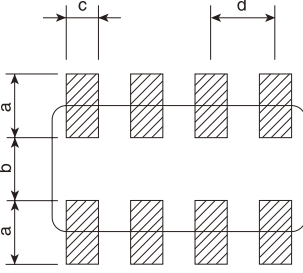
Stages	Precautions	Technical considerations																																																																																																					
1. Circuit Design	<p>◆Verification of operating environment, electrical rating and performance</p> <p>1. A malfunction in medical equipment, spacecraft, nuclear reactors, etc. may cause serious harm to human life or have severe social ramifications. As such, any inductors to be used in such equipment may require higher safety and/or reliability considerations and should be clearly differentiated from components used in general purpose applications.</p> <p>◆Operating Current (Verification of Rated current)</p> <p>1. The operating current for inductors must always be lower than their rated values.</p> <p>2. Do not apply current in excess of the rated value because the inductance may be reduced due to the magnetic saturation effect.</p>																																																																																																						
2. PCB Design	<p>◆Pattern configurations (Design of Land-patterns)</p> <p>1. When inductors are mounted on a PCB, the size of land patterns and the amount of solder used (size of fillet) can directly affect inductor performance. Therefore, the following items must be carefully considered in the design of solder land patterns:</p> <p>(1) The amount of solder applied can affect the ability of chips to withstand mechanical stresses which may lead to breaking or cracking. Therefore, when designing land-patterns it is necessary to consider the appropriate size and configuration of the solder pads which in turn determines the amount of solder necessary to form the fillets.</p> <p>(2) When more than one part is jointly soldered onto the same land or pad, the pad must be designed so that each component's soldering point is separated by solder-resist.</p> <p>(3) The larger size of land patterns and amount of solder, the smaller Q value after mounting on PCB. It makes higher the Q value to design land patterns smaller than terminal electrode of chips.</p>	<p>1. The following diagrams and tables show some examples of recommended patterns to prevent excessive solder amounts (larger fillets which extend above the component end terminations). Examples of improper pattern designs are also shown.</p> <p>(1) Recommended land dimensions for a typical chip inductor land patterns for PCBs</p>  <p>Recommended land dimensions for wave-soldering (unit: mm)</p> <table border="1" data-bbox="849 1157 1268 1343"> <thead> <tr> <th>Type</th> <th>1608</th> <th>2125</th> <th>3216</th> </tr> </thead> <tbody> <tr> <td rowspan="2">Size</td> <td>L</td> <td>1.6</td> <td>2.0</td> <td>3.2</td> </tr> <tr> <td>W</td> <td>0.8</td> <td>1.25</td> <td>1.6</td> </tr> <tr> <td>A</td> <td>0.8~1.0</td> <td>1.0~1.4</td> <td>1.8~2.5</td> </tr> <tr> <td>B</td> <td>0.5~0.8</td> <td>0.8~1.5</td> <td>0.8~1.7</td> </tr> <tr> <td>C</td> <td>0.6~0.8</td> <td>0.9~1.2</td> <td>1.2~1.6</td> </tr> </tbody> </table> <p>Recommended land dimensions for reflow-soldering (unit: mm)</p> <table border="1" data-bbox="849 1397 1465 1583"> <thead> <tr> <th>Type</th> <th>0603</th> <th>1005</th> <th>105</th> <th>1608</th> <th>2125</th> <th>3216</th> <th>2520</th> </tr> </thead> <tbody> <tr> <td rowspan="2">Size</td> <td>L</td> <td>0.6</td> <td>1.0</td> <td>1.0</td> <td>1.6</td> <td>2.0</td> <td>3.2</td> <td>2.5</td> </tr> <tr> <td>W</td> <td>0.3</td> <td>0.5</td> <td>0.6</td> <td>0.8</td> <td>1.25</td> <td>1.6</td> <td>2.0</td> </tr> <tr> <td>A</td> <td>0.20~0.30</td> <td>0.45~0.55</td> <td>0.50~0.55</td> <td>0.6~0.8</td> <td>0.8~1.2</td> <td>1.8~2.5</td> <td>1.0~1.4</td> </tr> <tr> <td>B</td> <td>0.20~0.30</td> <td>0.40~0.50</td> <td>0.30~0.40</td> <td>0.6~0.8</td> <td>0.8~1.2</td> <td>0.6~1.5</td> <td>0.6~1.0</td> </tr> <tr> <td>C</td> <td>0.25~0.40</td> <td>0.45~0.55</td> <td>0.60~0.70</td> <td>0.6~0.8</td> <td>0.9~1.6</td> <td>1.2~2.0</td> <td>1.8~2.2</td> </tr> </tbody> </table> <p>Excess solder can affect the ability of chips to withstand mechanical stresses. Therefore, please take proper precautions when designing land-patterns.</p>  <p>Recommended land dimension for Reflow-soldering (unit: mm)</p> <table border="1" data-bbox="1189 1758 1465 1976"> <thead> <tr> <th></th> <th></th> <th>3216</th> <th>2010</th> </tr> </thead> <tbody> <tr> <td rowspan="2">Size</td> <td>L</td> <td>3.2</td> <td>2.0</td> </tr> <tr> <td>W</td> <td>1.6</td> <td>1.0</td> </tr> <tr> <td>a</td> <td></td> <td>0.7~0.9</td> <td>0.5~0.6</td> </tr> <tr> <td>b</td> <td></td> <td>0.8~1.0</td> <td>0.5~0.6</td> </tr> <tr> <td>c</td> <td></td> <td>0.4~0.5</td> <td>0.2~0.3</td> </tr> <tr> <td>d</td> <td></td> <td>0.8</td> <td>0.5</td> </tr> </tbody> </table>	Type	1608	2125	3216	Size	L	1.6	2.0	3.2	W	0.8	1.25	1.6	A	0.8~1.0	1.0~1.4	1.8~2.5	B	0.5~0.8	0.8~1.5	0.8~1.7	C	0.6~0.8	0.9~1.2	1.2~1.6	Type	0603	1005	105	1608	2125	3216	2520	Size	L	0.6	1.0	1.0	1.6	2.0	3.2	2.5	W	0.3	0.5	0.6	0.8	1.25	1.6	2.0	A	0.20~0.30	0.45~0.55	0.50~0.55	0.6~0.8	0.8~1.2	1.8~2.5	1.0~1.4	B	0.20~0.30	0.40~0.50	0.30~0.40	0.6~0.8	0.8~1.2	0.6~1.5	0.6~1.0	C	0.25~0.40	0.45~0.55	0.60~0.70	0.6~0.8	0.9~1.6	1.2~2.0	1.8~2.2			3216	2010	Size	L	3.2	2.0	W	1.6	1.0	a		0.7~0.9	0.5~0.6	b		0.8~1.0	0.5~0.6	c		0.4~0.5	0.2~0.3	d		0.8	0.5
Type	1608	2125	3216																																																																																																				
Size	L	1.6	2.0	3.2																																																																																																			
	W	0.8	1.25	1.6																																																																																																			
A	0.8~1.0	1.0~1.4	1.8~2.5																																																																																																				
B	0.5~0.8	0.8~1.5	0.8~1.7																																																																																																				
C	0.6~0.8	0.9~1.2	1.2~1.6																																																																																																				
Type	0603	1005	105	1608	2125	3216	2520																																																																																																
Size	L	0.6	1.0	1.0	1.6	2.0	3.2	2.5																																																																																															
	W	0.3	0.5	0.6	0.8	1.25	1.6	2.0																																																																																															
A	0.20~0.30	0.45~0.55	0.50~0.55	0.6~0.8	0.8~1.2	1.8~2.5	1.0~1.4																																																																																																
B	0.20~0.30	0.40~0.50	0.30~0.40	0.6~0.8	0.8~1.2	0.6~1.5	0.6~1.0																																																																																																
C	0.25~0.40	0.45~0.55	0.60~0.70	0.6~0.8	0.9~1.6	1.2~2.0	1.8~2.2																																																																																																
		3216	2010																																																																																																				
Size	L	3.2	2.0																																																																																																				
	W	1.6	1.0																																																																																																				
a		0.7~0.9	0.5~0.6																																																																																																				
b		0.8~1.0	0.5~0.6																																																																																																				
c		0.4~0.5	0.2~0.3																																																																																																				
d		0.8	0.5																																																																																																				

Precautions on the use of Multilayer chip Inductors, Multilayer chip inductors for high frequency, Multilayer ferrite chip beads

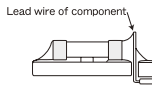
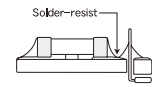
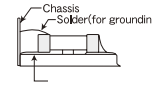
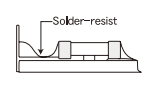
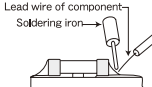
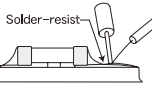
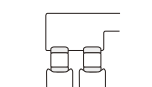
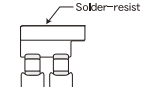
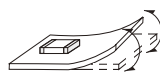
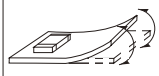
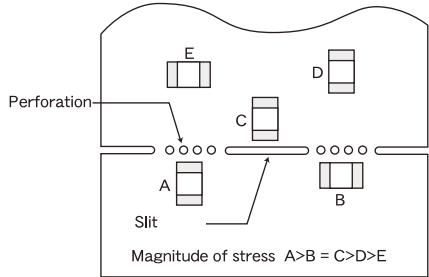
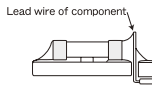
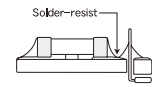
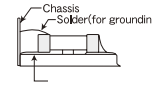
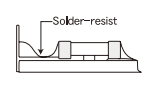
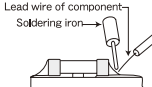
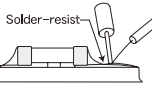
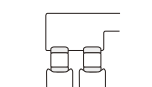
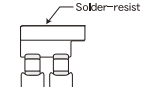
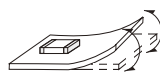
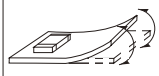
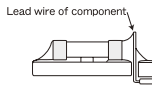
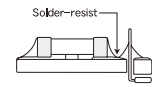
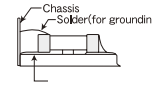
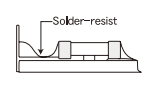
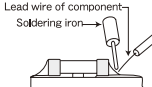
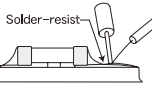
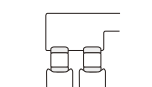
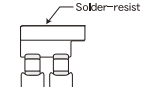
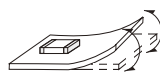
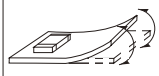
Stages	Precautions	Technical considerations																					
2.PCB Design	<p>◆Pattern configurations (Inductor layout on panelized [breakaway] PC boards)</p> <p>1. After inductors have been mounted on the boards, chips can be subjected to mechanical stresses in subsequent manufacturing processes (PCB cutting, board inspection, mounting of additional parts, assembly into the chassis, wave soldering the reflow soldered boards etc.) For this reason, planning pattern configurations and the position of SMD inductors should be carefully performed to minimize stress.</p>	<p>(2) Examples of good and bad solder application</p> <table border="1" data-bbox="852 299 1453 729"> <thead> <tr> <th></th> <th>Not recommended</th> <th>Recommended</th> </tr> </thead> <tbody> <tr> <td>Mixed mounting of SMD and leaded components</td> <td></td> <td></td> </tr> <tr> <td>Component placement close to the chassis</td> <td></td> <td></td> </tr> <tr> <td>Hand-soldering of leaded components near mounted components</td> <td></td> <td></td> </tr> <tr> <td>Horizontal component placement</td> <td></td> <td></td> </tr> </tbody> </table> <p>1-1. The following are examples of good and bad inductor layout; SMD inductors should be located to minimize any possible mechanical stresses from board warp or deflection.</p> <table border="1" data-bbox="852 847 1453 995"> <thead> <tr> <th>Item</th> <th>Not recommended</th> <th>Recommended</th> </tr> </thead> <tbody> <tr> <td>Deflection of the board</td> <td></td> <td></td> </tr> </tbody> </table> <p>1-2. To layout the inductors for the breakaway PC board, it should be noted that the amount of mechanical stresses given will vary depending on inductor layout. An example below should be counted for better design.</p> <div data-bbox="909 1109 1340 1386" style="text-align: center;">  <p>Magnitude of stress $A > B = C > D > E$</p> </div> <p>1-3. When breaking PC boards along their perforations, the amount of mechanical stress on the inductors can vary according to the method used. The following methods are listed in order from least stressful to most stressful: push-back, slit, V-grooving, and perforation. Thus, any ideal SMD inductor layout must also consider the PCB splitting procedure.</p>		Not recommended	Recommended	Mixed mounting of SMD and leaded components			Component placement close to the chassis			Hand-soldering of leaded components near mounted components			Horizontal component placement			Item	Not recommended	Recommended	Deflection of the board		
	Not recommended	Recommended																					
Mixed mounting of SMD and leaded components																							
Component placement close to the chassis																							
Hand-soldering of leaded components near mounted components																							
Horizontal component placement																							
Item	Not recommended	Recommended																					
Deflection of the board																							

Precautions on the use of Multilayer chip Inductors, Multilayer chip inductors for high frequency, Multilayer ferrite chip beads

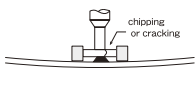
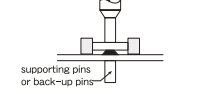
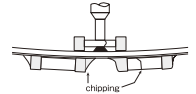
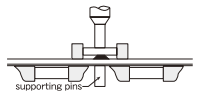
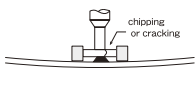
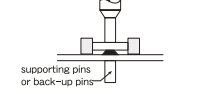
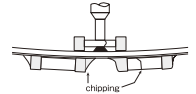
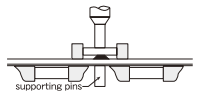
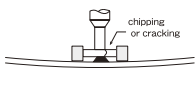
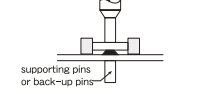
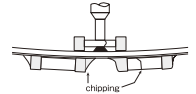
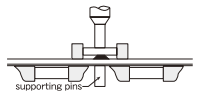
Stages	Precautions	Technical considerations									
<p>3.Considerations for automatic placement</p>	<p>◆Adjustment of mounting machine</p> <ol style="list-style-type: none"> Excessive impact load should not be imposed on the inductors when mounting onto the PC boards. The maintenance and inspection of the mounter should be conducted periodically. <p>◆Selection of Adhesives</p> <ol style="list-style-type: none"> Mounting inductors with adhesives in preliminary assembly, before the soldering stage, may lead to degraded inductor characteristics unless the following factors are appropriately checked; the size of land patterns, type of adhesive, amount applied, hardening temperature and hardening period. Therefore, it is imperative to consult the manufacturer of the adhesives on proper usage and amounts of adhesive to use. 	<ol style="list-style-type: none"> If the lower limit of the pick-up nozzle is low, too much force may be imposed on the inductors, causing damage. To avoid this, the following points should be considered before lowering the pick-up nozzle: <ol style="list-style-type: none"> The lower limit of the pick-up nozzle should be adjusted to the surface level of the PC board after correcting for deflection of the board. The pick-up pressure should be adjusted between 1 and 3 N static loads. To reduce the amount of deflection of the board caused by impact of the pick-up nozzle, supporting pins or back-up pins should be used under the PC board. The following diagrams show some typical examples of good pick-up nozzle placement: <table border="1" data-bbox="847 535 1453 805"> <thead> <tr> <th></th> <th>Improper method</th> <th>Proper method</th> </tr> </thead> <tbody> <tr> <td>Single-sided mounting</td> <td></td> <td></td> </tr> <tr> <td>Double-sided mounting</td> <td></td> <td></td> </tr> </tbody> </table> <ol style="list-style-type: none"> As the alignment pin wears out, adjustment of the nozzle height can cause chipping or cracking of the inductors because of mechanical impact on the inductors. To avoid this, the monitoring of the width between the alignment pin in the stopped position, and maintenance, inspection and replacement of the pin should be conducted periodically. <ol style="list-style-type: none"> Some adhesives may cause reduced insulation resistance. The difference between the shrinkage percentage of the adhesive and that of the inductors may result in stresses on the inductors and lead to cracking. Moreover, too little or too much adhesive applied to the board may adversely affect component placement, so the following precautions should be noted in the application of adhesives. <ol style="list-style-type: none"> Required adhesive characteristics <ol style="list-style-type: none"> The adhesive should be strong enough to hold parts on the board during the mounting & solder process. The adhesive should have sufficient strength at high temperatures. The adhesive should have good coating and thickness consistency. The adhesive should be used during its prescribed shelf life. The adhesive should harden rapidly The adhesive must not be contaminated. The adhesive should have excellent insulation characteristics. The adhesive should not be toxic and have no emission of toxic gasses. 		Improper method	Proper method	Single-sided mounting			Double-sided mounting		
	Improper method	Proper method									
Single-sided mounting											
Double-sided mounting											

Precautions on the use of Multilayer chip Inductors, Multilayer chip inductors for high frequency, Multilayer ferrite chip beads

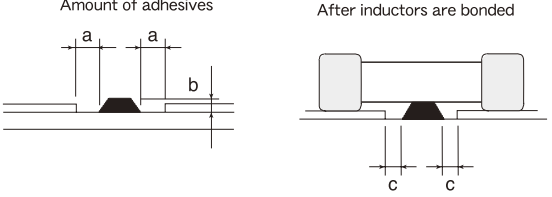
Stages	Precaution	Technical considerations								
3.Considerations for automatic placement		<p>When using adhesives to mount inductors on a PCB, inappropriate amounts of adhesive on the board may adversely affect component placement. Too little adhesive may cause the inductors to fall off the board during the solder process. Too much adhesive may cause defective soldering due excessive flow of adhesive on to the land or solder pad.</p> <p>[Recommended conditions]</p> <table border="1" data-bbox="898 447 1449 567"> <thead> <tr> <th>Figure</th> <th>0805 case sizes as examples</th> </tr> </thead> <tbody> <tr> <td>a</td> <td>0.3mm min</td> </tr> <tr> <td>b</td> <td>100 ~120 μm</td> </tr> <tr> <td>c</td> <td>Area with no adhesive</td> </tr> </tbody> </table> 	Figure	0805 case sizes as examples	a	0.3mm min	b	100 ~120 μm	c	Area with no adhesive
Figure	0805 case sizes as examples									
a	0.3mm min									
b	100 ~120 μm									
c	Area with no adhesive									
4.Soldering	<p>◆Selection of Flux</p> <ol style="list-style-type: none"> Since flux may have a significant effect on the performance of inductors, it is necessary to verify the following conditions prior to use; <ol style="list-style-type: none"> Flux used should be with less than or equal to 0.1 wt% (Chlorine conversion method) of halogenated content. Flux having a strong acidity content should not be applied. When soldering inductors on the board, the amount of flux applied should be controlled at the optimum level. When using water-soluble flux, special care should be taken to properly clean the boards. <p>◆Soldering</p> <p>Temperature, time, amount of solder, etc. are specified in accordance with the following recommended conditions.</p>	<ol style="list-style-type: none"> When too much halogenated substance (Chlorine, etc.) content is used to activate the flux, or highly acidic flux is used, an excessive amount of residue after soldering may lead to corrosion of the terminal electrodes or degradation of insulation resistance on the surface of the Inductor. <ol style="list-style-type: none"> Flux is used to increase solderability in flow soldering, but if too much is applied, a large amount of flux gas may be emitted and may detrimentally affect solderability. To minimize the amount of flux applied, it is recommended to use a flux-bubbling system. Since the residue of water-soluble flux is easily dissolved by water content in the air, the residue on the surface of Inductor in high humidity conditions may cause a degradation of insulation resistance and therefore affect the reliability of the components. The cleaning methods and the capability of the machines used should also be considered carefully when selecting water-soluble flux. Preheating when soldering <p>Heating: Chip inductor components should be preheated to within 100 to 130°C of the soldering. Cooling: The temperature difference between the components and cleaning process should not be greater than 100 °C.</p> <p>Chip inductors are susceptible to thermal shock when exposed to rapid or concentrated heating or rapid cooling. Therefore, the soldering process must be conducted with a great care so as to prevent malfunction of the components due to excessive thermal shock.</p> 								

Precautions on the use of Multilayer chip Inductors, Multilayer chip inductors for high frequency, Multilayer ferrite chip beads

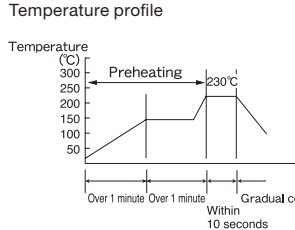
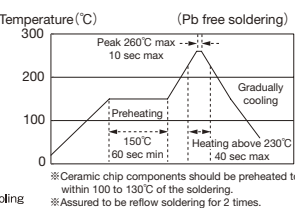
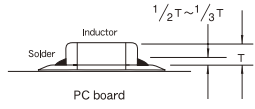
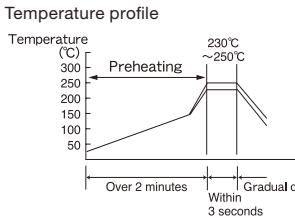
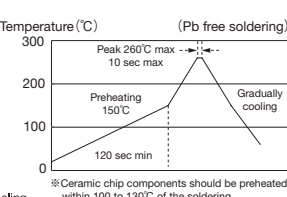
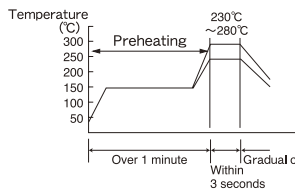
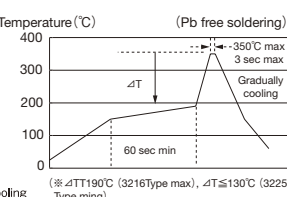
Stages	Precautions	Technical considerations
4.Soldering	<p>◆And please contact us about peak temperature when you use lead-free paste.</p>	<p>Recommended conditions for soldering</p> <p>[Reflow soldering]</p> <p>Temperature profile</p>   <p>Caution</p> <ol style="list-style-type: none"> The ideal condition is to have solder mass (fillet) controlled to 1/2 to 1/3 of the thickness of the inductor, as shown below:  <ol style="list-style-type: none"> Because excessive dwell times can detrimentally affect solderability, soldering duration should be kept as close to recommended times as possible. <p>[Wave soldering]</p> <p>Temperature profile</p>   <p>Caution</p> <ol style="list-style-type: none"> Make sure the inductors are preheated sufficiently. The temperature difference between the inductor and melted solder should not be greater than 100 to 130°C Cooling after soldering should be as gradual as possible. Wave soldering must not be applied to the inductors designated as for reflow soldering only. <p>[Hand soldering]</p> <p>Temperature profile</p>   <p>Caution</p> <ol style="list-style-type: none"> Use a 20W soldering iron with a maximum tip diameter of 1.0 mm. The soldering iron should not directly touch the inductor.
5.Cleaning	<p>◆Cleaning conditions</p> <ol style="list-style-type: none"> When cleaning the PC board after the Inductors are all mounted, select the appropriate cleaning solution according to the type of flux used and purpose of the cleaning (e.g. to remove soldering flux or other materials from the production process.) 	<ol style="list-style-type: none"> The use of inappropriate solutions can cause foreign substances such as flux residue to adhere to the inductor, resulting in a degradation of the inductor's electrical properties (especially insulation resistance).

Precautions on the use of Multilayer chip Inductors, Multilayer chip inductors for high frequency, Multilayer ferrite chip beads

Stages	Precautions	Technical considerations						
5.Cleaning	2. Cleaning conditions should be determined after verifying, through a test run, that the cleaning process does not affect the inductor's characteristics.	2. Inappropriate cleaning conditions (insufficient or excessive cleaning) may detrimentally affect the performance of the inductors. (1) Excessive cleaning In the case of ultrasonic cleaning, too much power output can cause excessive vibration of the PC board which may lead to the cracking of the inductor or the soldered portion, or decrease the terminal electrodes' strength. Thus the following conditions should be carefully checked; <table border="0" style="width: 100%;"> <tr> <td style="width: 60%;">Ultrasonic output</td> <td>Below 20 w/ℓ</td> </tr> <tr> <td>Ultrasonic frequency</td> <td>Below 40 kHz</td> </tr> <tr> <td>Ultrasonic washing period</td> <td>5 min. or less</td> </tr> </table>	Ultrasonic output	Below 20 w/ℓ	Ultrasonic frequency	Below 40 kHz	Ultrasonic washing period	5 min. or less
Ultrasonic output	Below 20 w/ℓ							
Ultrasonic frequency	Below 40 kHz							
Ultrasonic washing period	5 min. or less							
6. Post cleaning processes	◆Application of resin coatings, moldings, etc. to the PCB and components. 1. With some type of resins a decomposition gas or chemical reaction vapor may remain inside the resin during the hardening period or while left under normal storage conditions resulting in the deterioration of the inductor's performance. 2. When a resin's hardening temperature is higher than the inductor's operating temperature, the stresses generated by the excess heat may lead to inductor damage or destruction. 3. Stress caused by a resin's temperature generated expansion and contraction may damage inductors. The use of such resins, molding materials etc. is not recommended.							
7. Handling	◆Breakaway PC boards (splitting along perforations) 1. When splitting the PC board after mounting inductors and other components, care is required so as not to give any stresses of deflection or twisting to the board. 2. Board separation should not be done manually, but by using the appropriate devices. ◆General handling precautions 1. Always wear static control bands to protect against ESD. 2. Keep the inductors away from all magnets and magnetic objects. 3. Use non-magnetic tweezers when handling inductors. 4. Any devices used with the inductors (soldering irons, measuring instruments) should be properly grounded. 5. Keep bare hands and metal products (i.e., metal desk) away from chip electrodes or conductive areas that lead to chip electrodes. 6. Keep inductors away from items that generate magnetic fields such as speakers or coils. ◆Mechanical considerations 1. Be careful not to subject the inductors to excessive mechanical shocks. (1) If inductors are dropped on the floor or a hard surface they should not be used. (2) When handling the mounted boards, be careful that the mounted components do not come in contact with or bump against other boards or components.							

Precautions on the use of Multilayer chip Inductors, Multilayer chip inductors for high frequency, Multilayer ferrite chip beads

Stages	Precautions	Technical considerations
8. Storage conditions	<p>◆Storage</p> <p>1. To maintain the solderability of terminal electrodes and to keep the packaging material in good condition, care must be taken to control temperature and humidity in the storage area. Humidity should especially be kept as low as possible.</p> <p>Recommended conditions Ambient temperature Below 40 °C Humidity Below 70% RH</p> <p>The ambient temperature must be kept below 30 °C. Even under ideal storage conditions inductor electrode solderability decreases as time passes, so inductors should be used within 6 months from the time of delivery.</p> <p>*The packaging material should be kept where no chlorine or sulfur exists in the air.</p>	<p>1. If the parts are stocked in a high temperature and humidity environment, problems such as reduced solderability caused by oxidation of terminal electrodes and deterioration of taping/packaging materials may take place. For this reason, components should be used within 6 months from the time of delivery. If exceeding the above period, please check solderability before using the inductors</p>