

10-Element Bar Graph Array

Technical Data

HLCP-J100
HDSP-4820
HDSP-4830
HDSP-4832

Features

- Custom Multicolor Array Capability
- Matched LEDs for Uniform Appearance
- End Stackable
- Package Interlock Ensures Correct Alignment
- Low Profile Package
- Rugged Construction
- Large, Easily Recognizable Segments
- High ON-OFF Contrast, Segment to Segment
- Wide Viewing Angle
- Categorized for Luminous Intensity
- HDSP-4832/4836/4840/4850 Categorized for Dominant Wavelength
- HLCP-J100 Operates at Low Current
 Typical Intensity of 1.0 mcd at 1 mA Drive Current

Applications

- Industrial Controls
- Instrumentation
- Office Equipment
- Computer Peripherals
- Consumer Products

Description

These 10-element LED arrays are designed to display information in easily recognizable bar graph form. The packages are end stackable and therefore capable of displaying long strings of information. Use of these bar graph arrays eliminates the alignment, intensity, and color matching problems associated with discrete LEDs. The HDSP-4820/4830/4840/4850 and HLCP-J100 each contain LEDs of one color. The HDSP-4832/4836 are multicolor arrays with High Efficiency Red, Yellow, and High Performance Green LEDs in a single package.

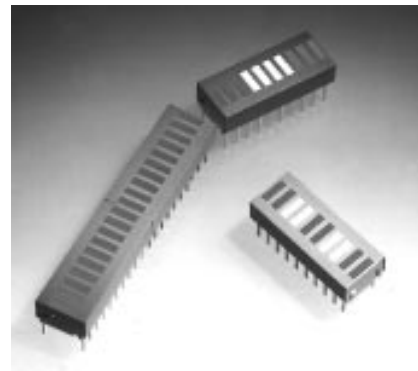

CUSTOM MULTICOLOR ARRAYS ARE AVAILABLE WITH MINIMUM DELIVERY REQUIREMENTS. CONTACT YOUR LOCAL DISTRIBUTOR OR HP SALES OFFICE FOR DETAILS.

Package Dimensions

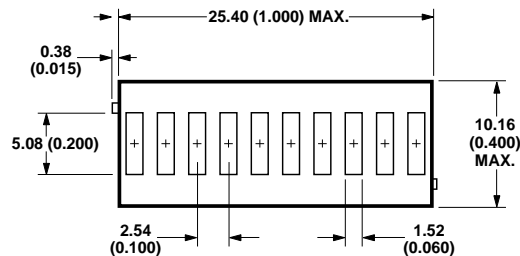

1. DIMENSIONS IN MILLIMETERS (INCHES).
2. ALL UNTOLERANCED DIMENSIONS FOR REFERENCE ONLY.
3. HDSP-4832/-4836/-4840/-4850 ONLY.

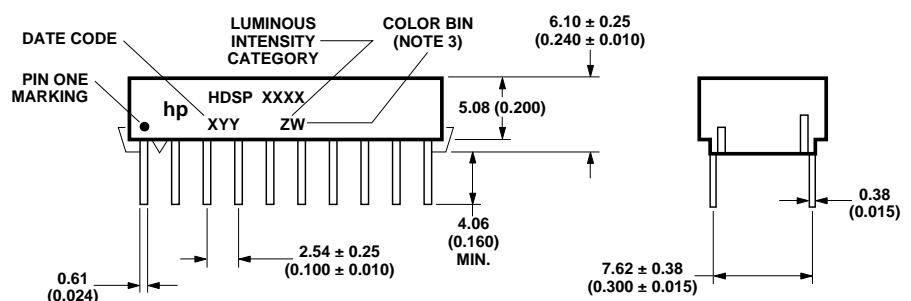

Absolute Maximum Ratings^[7]

Parameter	Red HDSP-4820	AlGaAs Red HLCP-J100	HER HDSP-4830	Yellow HDSP-4840	Green HDSP-4850
Average Power Dissipation per LED ($T_A = 25^\circ\text{C}$)	63 mW	37 mW	87 mW	50 mW	105 mW
Peak Forward Current per LED	150 mA ^[1]	45 mA ^[2]	90 mA ^[3]	60 mA ^[3]	90 mA ^[3]
DC Forward Current per LED	30 mA ^[4]	15 mA ^[4]	30 mA ^[5]	20 mA ^[5]	30 mA ^[5]
Operating Temperature Range	-40°C to +85°C	-20°C to +100°C	-40°C to +85°C		-20°C to +85°C
Storage Temperature Range	-40°C to +85°C	-55°C to +100°C	-40°C to +85°C		
Reverse Voltage per LED	3.0 V	5.0 V	3.0 V		
Lead Soldering Temperature (1.59 mm (1/16 inch) below seating plane) ^[6]	260°C for 3 seconds ^[8]				

Notes:

- See Figure 1 to establish pulsed operating conditions. Maximum pulse width is 1.5 ms.
- See Figure 2 to establish pulsed operating conditions. Maximum pulse width is 1.5 ms.
- See Figure 8 to establish pulsed operating conditions. Maximum pulse width is 2 ms.
- Derate maximum DC current for Red above $T_A = 62^\circ\text{C}$ at 0.79 mA/°C, and AlGaAs Red above $T_A = 91^\circ\text{C}$ at 0.8 mA/°C. See Figure 3.
- Derate maximum DC current for HER above $T_A = 48^\circ\text{C}$ at 0.58 mA/°C, Yellow above $T_A = 70^\circ\text{C}$ at 0.66 mA/°C, and Green above $T_A = 37^\circ\text{C}$ at 0.48 mA/°C. See Figure 9.
- Clean only in water, isopropanol, ethanol, Freon TF or TE (or equivalent), or Genesolve DI-15 (or equivalent).
- Absolute maximum ratings for HER, Yellow, and Green elements of the multicolor arrays are identical to the HDSP-4830/4840/4850 maximum ratings.
- Maximum tolerable component side temperature is 134°C during solder process.

Internal Circuit Diagram

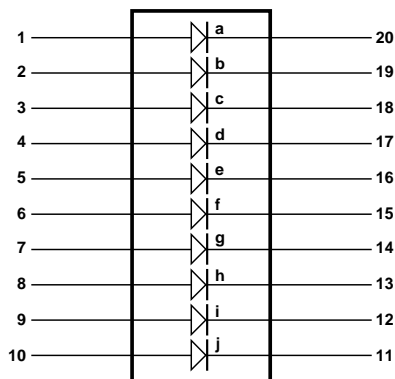

Pin	Function	Pin	Function
1	Anode a	11	Cathode j
2	Anode b	12	Cathode i
3	Anode c	13	Cathode h
4	Anode d	14	Cathode g
5	Anode e	15	Cathode f
6	Anode f	16	Cathode e
7	Anode g	17	Cathode d
8	Anode h	18	Cathode c
9	Anode i	19	Cathode b
10	Anode j	20	Cathode a

Multicolor Array Segment Colors

Segment	HDSP-4832 Segment Color	HDSP-4836 Segment Color
a	HER	HER
b	HER	HER
c	HER	Yellow
d	Yellow	Yellow
e	Yellow	Green
f	Yellow	Green
g	Yellow	Yellow
h	Green	Yellow
i	Green	HER
j	Green	HER

Electrical/Optical Characteristics at $T_A = 25^\circ\text{C}$ ^[4]

Red HDSP-4820

Parameter	Symbol	Min.	Typ.	Max.	Units	Test Conditions
Luminous Intensity per LED (Unit Average) ^[1]	I_V	610	1250		μcd	$I_F = 20\text{ mA}$
Peak Wavelength	λ_{PEAK}		655		nm	
Dominant Wavelength ^[2]	λ_d		645		nm	
Forward Voltage per LED	V_F		1.6	2.0	V	$I_F = 20\text{ mA}$
Reverse Voltage per LED ^[5]	V_R	3	12		V	$I_R = 100\ \mu\text{A}$
Temperature Coefficient V_F per LED	$\Delta V_F/^\circ\text{C}$		-2.0		mV/ $^\circ\text{C}$	
Thermal Resistance LED Junction-to-Pin	$R\theta_{\text{J-PIN}}$		300		$^\circ\text{C/W/LED}$	

AlGaAs Red HLCP-J100

Parameter	Symbol	Min.	Typ.	Max.	Units	Test Conditions
Luminous Intensity per LED (Unit Average) ^[1]	I_V	600	1000		μcd	$I_F = 1\text{ mA}$
			5200			$I_F = 20\text{ mA Pk};$ 1 of 4 Duty Factor
Peak Wavelength	λ_{PEAK}		645		nm	
Dominant Wavelength ^[2]	λ_d		637		nm	
Forward Voltage per LED	V_F		1.6		V	$I_F = 1\text{ mA}$
			1.8	2.2		$I_F = 20\text{ mA}$
Reverse Voltage per LED ^[5]	V_R	5	15		V	$I_R = 100\ \mu\text{A}$
Temperature Coefficient V_F per LED	$\Delta V_F/^\circ\text{C}$		-2.0		mV/ $^\circ\text{C}$	
Thermal Resistance LED Junction-to-Pin	$R\theta_{\text{J-PIN}}$		300		$^\circ\text{C/W/LED}$	

High Efficiency Red HDSP-4830

Parameter	Symbol	Min.	Typ.	Max.	Units	Test Conditions
Luminous Intensity per LED (Unit Average) ^[1,4]	I_V	900	3500		μcd	$I_F = 10 \text{ mA}$
Peak Wavelength	λ_{PEAK}		635		nm	
Dominant Wavelength ^[2]	λ_d		626		nm	
Forward Voltage per LED	V_F		2.1	2.5	V	$I_F = 20 \text{ mA}$
Reverse Voltage per LED ^[5]	V_R	3	30		V	$I_R = 100 \mu\text{A}$
Temperature Coefficient V_F per LED	$\Delta V_F / ^\circ\text{C}$		-2.0		mV/ $^\circ\text{C}$	
Thermal Resistance LED Junction-to-Pin	$R\theta_{\text{J-PIN}}$		300		$^\circ\text{C/W/LED}$	

Yellow HDSP-4840

Parameter	Symbol	Min.	Typ.	Max.	Units	Test Conditions
Luminous Intensity per LED (Unit Average) ^[1,4]	I_V	600	1900		μcd	$I_F = 10 \text{ mA}$
Peak Wavelength	λ_{PEAK}		583		nm	
Dominant Wavelength ^[2,3]	λ_d	581	585	592	nm	
Forward Voltage per LED	V_F		2.2	2.5	V	$I_F = 20 \text{ mA}$
Reverse Voltage per LED ^[5]	V_R	3	40		V	$I_R = 100 \mu\text{A}$
Temperature Coefficient V_F per LED	$\Delta V_F / ^\circ\text{C}$		-2.0		mV/ $^\circ\text{C}$	
Thermal Resistance LED Junction-to-Pin	$R\theta_{\text{J-PIN}}$		300		$^\circ\text{C/W/LED}$	

Green HDSP-4850

Parameter	Symbol	Min.	Typ.	Max.	Units	Test Conditions
Luminous Intensity per LED (Unit Average) ^[1,4]	I_V	600	1900		μcd	$I_F = 10 \text{ mA}$
Peak Wavelength	λ_{PEAK}		566		nm	
Dominant Wavelength ^[2,3]	λ_d		571	577	nm	
Forward Voltage per LED	V_F		2.1	2.5	V	$I_F = 10 \text{ mA}$
Reverse Voltage per LED ^[5]	V_R	3	50		V	$I_R = 100 \mu\text{A}$
Temperature Coefficient V_F per LED	$\Delta V_F / ^\circ\text{C}$		-2.0		mV/ $^\circ\text{C}$	
Thermal Resistance LED Junction-to-Pin	$R\theta_{\text{J-PIN}}$		300		$^\circ\text{C/W/LED}$	

Notes:

1. The bar graph arrays are categorized for luminous intensity. The category is designated by a letter located on the side of the package.
2. The dominant wavelength, λ_d , is derived from the CIE chromaticity diagram and is that single wavelength which defines the color of the device.
3. The HDSP-4832/-4836/-4840/-4850 bar graph arrays are categorized by dominant wavelength with the category designated by a number adjacent to the intensity category letter. Only the yellow elements of the HDSP-4832/-4836 are categorized for color.
4. Electrical/optical characteristics of the High-Efficiency Red elements of the HDSP-4832/-4836 are identical to the HDSP-4830 characteristics. Characteristics of Yellow elements of the HDSP-4832/-4836 are identical to the HDSP-4840. Characteristics of Green elements of the HDSP-4832/-4836 are identical to the HDSP-4850.
5. Reverse voltage per LED should be limited to 3.0 V max. for the HDSP-4820/-4830/-4840/-4850/-4832/-4836 and 5.0 V max. for the HLCP-J100.

Red, AlGaAs Red

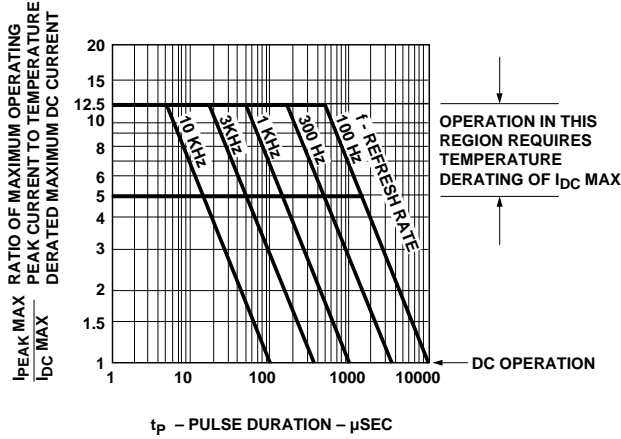

Figure 1. Maximum Tolerable Peak Current vs. Pulse Duration - Red.

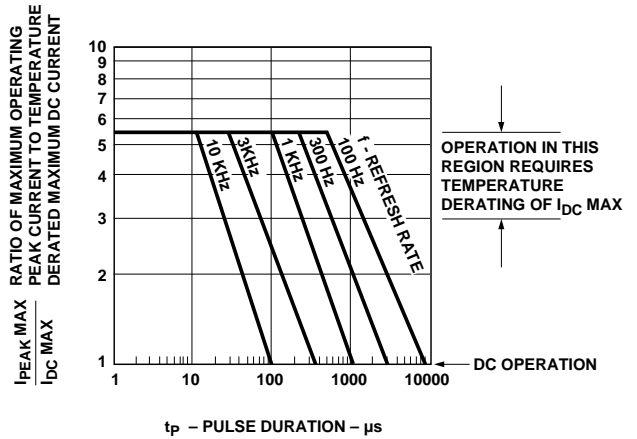

Figure 2. Maximum Tolerable Peak Current vs. Pulse Duration - AlGaAs Red.

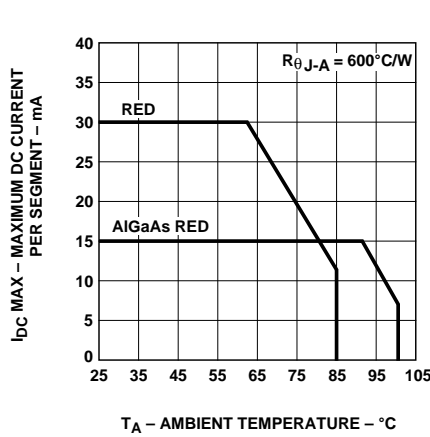

Figure 3. Maximum Allowable DC Current vs. Ambient Temperature.
 $T_{JMAX} = 100^{\circ}C$ for Red and
 $T_{JMAX} = 110^{\circ}C$ for AlGaAs Red.

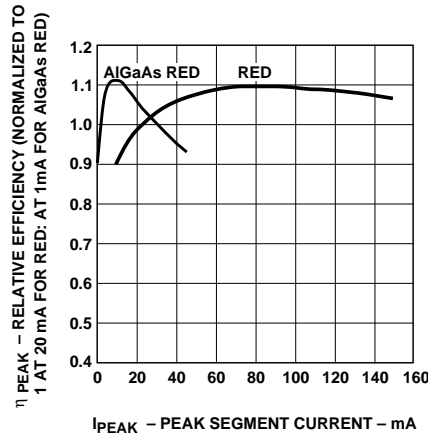

Figure 4. Relative Efficiency (Luminous Intensity per Unit Current) vs. Peak Current.

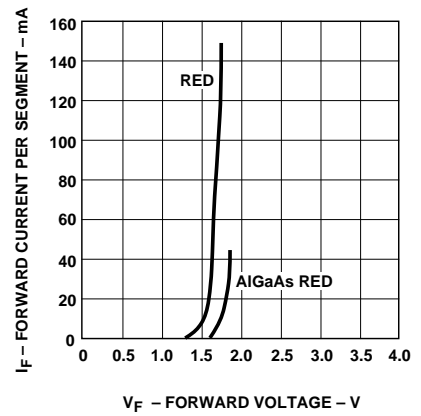

Figure 5. Forward Current vs. Forward Voltage.

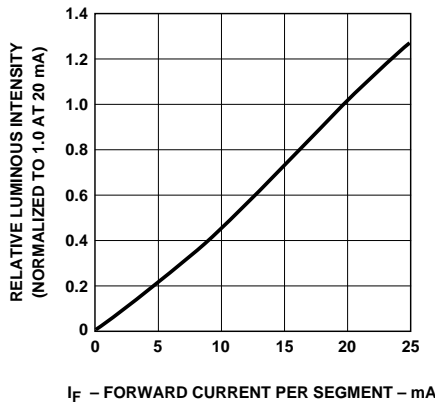

Figure 6. Relative Luminous Intensity vs. DC Forward Current - Red.

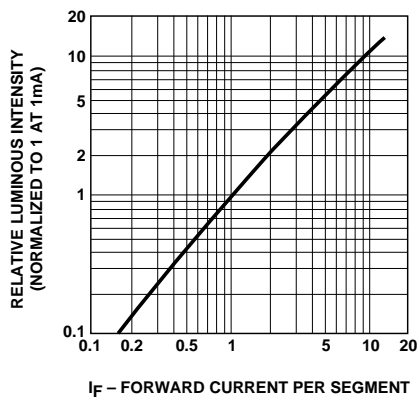

Figure 7. Relative Luminous Intensity vs. DC Forward Current - AlGaAs.

For a Detailed Explanation on the Use of Data Sheet Information and Recommended Soldering Procedures, See Application Note 1005.

HER, Yellow, Green

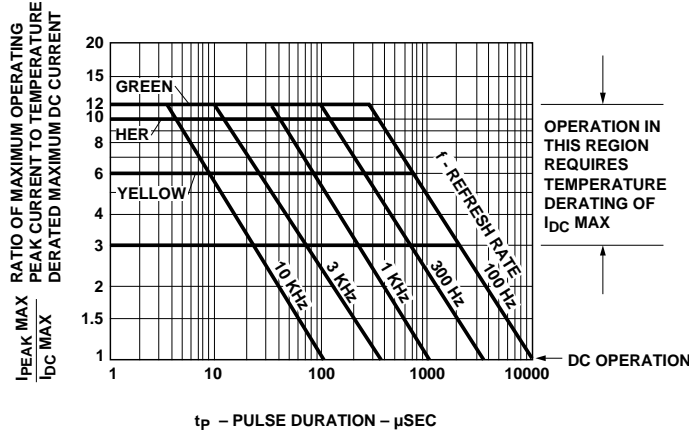

Figure 8. Maximum Tolerable Peak Current vs. Pulse Duration - HER/Yellow/Green.

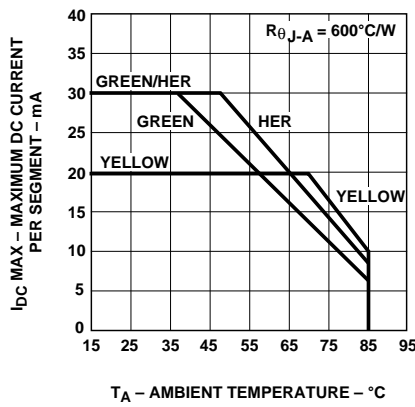

Figure 9. Maximum Allowable DC Current vs. Ambient Temperature. TjMAX = 100°C.

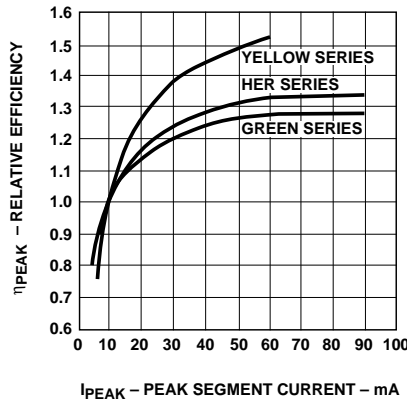

Figure 10. Relative Efficiency (Luminous Intensity per Unit Current) vs. Peak Current.

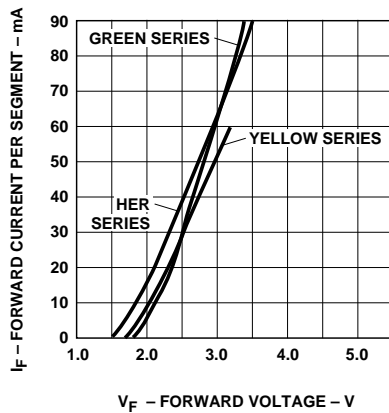

Figure 11. Forward Current vs. Forward Voltage.

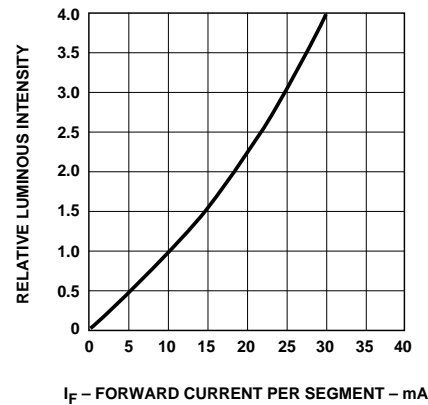

Figure 12. Relative Luminous Intensity vs. DC Forward Current.

For a Detailed Explanation on the Use of Data Sheet Information and Recommended Soldering Procedures, See Application Note 1005.

Electrical/Optical

These versatile bar graph arrays are composed of ten light emitting diodes. The light from each LED is optically stretched to form individual elements. The Red (HDSP-4820) bar graph array LEDs use a p-n junction diffused into a GaAs epitaxial layer on a GaAs substrate. The AlGaAs Red (HLCP-J100) bar graph array LEDs use double heterojunction AlGaAs on a GaAs substrate. HER (HDSP-4830) and Yellow (HDSP-4840) bar graph array LEDs use a GaAsP epitaxial layer on a GaP substrate. Green (HDSP-4850) bar graph array LEDs use liquid phase GaP epitaxial layer on a GaP substrate. The multicolor bar graph arrays (HDSP-4832/4836) have HER, Yellow, and Green LEDs in one package.

These displays are designed for strobed operation. The typical forward voltage values can be scaled from Figures 5 and 11. These values should be used to calculate the current limiting resistor value and typical power consumption. Expected maximum V_F values for driver circuit design and maximum power dissipation may be calculated using the V_{FMAX} models:

Standard Red HDSP-4820 series
 $V_{FMAX} = 1.8 \text{ V} + I_{Peak} (10 \Omega)$
 For: $I_{Peak} \geq 5 \text{ mA}$

AlGaAs Red HLCP-J100 series
 $V_{FMAX} = 1.8 \text{ V} + I_{Peak} (20 \Omega)$
 For: $I_{Peak} \leq 20 \text{ mA}$
 $V_{FMAX} = 2.0 \text{ V} + I_{Peak} (10 \Omega)$
 For: $I_{Peak} \geq 20 \text{ mA}$

HER (HDSP-4830) and Yellow (HDSP-4840) series
 $V_{FMAX} = 1.6 + I_{Peak} (45 \Omega)$
 For: $5 \text{ mA} \leq I_{Peak} \leq 20 \text{ mA}$
 $V_{FMAX} = 1.75 + I_{Peak} (38 \Omega)$
 For: $I_{Peak} \geq 20 \text{ mA}$

Green (HDSP-4850) series
 $V_{FMAX} = 2.0 + I_{Peak} (50 \Omega)$
 For: $I_{Peak} > 5 \text{ mA}$

Figures 4 and 10 allow the designer to calculate the luminous intensity at different peak and average currents. The following equation calculates intensity at different peak and average currents:

$$I_VAVG = (I_{F}AVG/I_{F}AVG \text{ DATA SHEET})\eta_{peak}(I_V\text{DATA SHEET})$$

Where:

I_VAVG is the calculated time averaged luminous intensity resulting from $I_{F}AVG$.

$I_{F}AVG$ is the desired time averaged LED current.

$I_{F}AVG \text{ DATA SHEET}$ is the data sheet test current for $I_V\text{DATA SHEET}$.

η_{peak} is the relative efficiency at the peak current, scaled from Figure 4 or 10.

$I_V \text{ DATA SHEET}$ is the data sheet luminous intensity, resulting from $I_{F}AVG \text{ DATA SHEET}$.

For example, what is the luminous intensity of an HDSP-4830 driven at 50 mA peak 1/5 duty factor?

$$I_{F}AVG = (50 \text{ mA})(0.2) = 10 \text{ mA}$$

$$I_{F}AVG \text{ DATA SHEET} = 10 \text{ mA}$$

$$\eta_{peak} = 1.3$$

$$I_V \text{ DATA SHEET} = 3500 \mu\text{cd}$$

Therefore

$$\begin{aligned} I_VAVG &= (10 \text{ mA}/10 \text{ mA}) \\ &\quad (1.3)(3500 \mu\text{cd}) \\ &= 4550 \mu\text{cd} \end{aligned}$$



For technical assistance or the location of your nearest Hewlett-Packard sales office, distributor or representative call:

Americas/Canada: 1-800-235-0312 or 408-654-8675

Far East/Australasia: Call your local HP sales office.

Japan: (81 3) 3335-8152

Europe: Call your local HP sales office.

Data subject to change.

Copyright © 1997 Hewlett-Packard Co.

Obsoletes 5954-0869, 5954-8465

Printed in U.S.A. 5963-7037E (4/97)