

Power Relay G2A-434

CSM_G2A-434_DS_E_3_1

Fully Sealed Version of G2A that Displays Its Power in Adverse Environments

- Exhibits stable performance in an adverse atmosphere of harmful gas, moisture, or powdery dust due to its hermetically sealed construction.
- All the mechanical components of the Relay have been annealed to prevent gas generation inside the Relay.
- Economical as compared with a hermetically sealed relay in a metallic enclosure.



Ordering Information

Contact form	Classification	Plug-in terminals	PCB terminals
4PDT	Standard model	G2A-434A(-D)(-N)(-N1)	G2A-4341P
	UL-approved model	G2A-434A-US	G2A-4341P-US

Note: When placing your order, add the coil voltage rating to the model number as shown below.

Example: G2A-434A-VS 200/220 VAC

Rated coil voltage

Model Number Legend

G2A-□□□□□□-□
1 2 3 4 5 6

1. Number of Poles and Contact Form

4: 4PDT

2. Contact Type

3: Crossbar bifurcated

3. Enclosure Construction

4: Fully sealed

4. Terminal Shape

A: Plug-in

1P: PCB

5. Safety Breaking Mechanism

None: No

Y: Arc barrier

6. Special Elements

None: Standard

D: Built-in diode

N: Built-in operation indicator

N1: Built-in operation indicator and diode

US: UL-approved

Accessories (Order Separately)

Sockets

Classification	DIN Track-mounting Socket	Back-connecting Socket			
	Screw terminals	Solder terminals	Wire-wrap terminals	PCB terminals	
Without Hold-down Clip	PYF14A(-E) PYF14A-TU PYF14T	PY14 PY14-3	PY14QN(2)	PY14-0	PY14-02
With Hold-down Clip	---	PY14-Y2	PY14QN(2)-Y2	---	---

Note: See the G2A datasheet for detailed information on Relay Hold-down Clips and Socket Mounting Plates.

Specifications

■ Coil Ratings

Rated voltage	Current		Coil resistance	Coil inductance (ref. value)		Must operate	Must release	Max. voltage	Power consumption
	50 Hz	60 Hz		Armature OFF	Armature ON				
6 VAC	295 mA	233 mA	8.9 Ω	0.048 H	0.065 H	80 % max.	30 % min.	110 %	Approx. 1.4 VA
24 VAC	73 mA	58 mA	136 Ω	0.691 H	1.04 H				
100/ 110 VAC	17.7/ 21.4 mA	14/ 16.8 mA	2,200 Ω	12.42/ 12.38 H	18/16.4 H				
200/ 220 VAC	8.9/ 10.8 mA	7/8.4 mA	8,800 Ω	42.2/ 41.8 H	72/65.5 H				
12 VDC	88 mA		136 Ω	0.6 H	1.0 H	10 % min.			Approx. 1.1 W
24 VDC	45 mA		530 Ω	2.7 H	4.6 H				
48 VDC	22 mA		2,200 Ω	11 H	19 H				
100 VDC	11.4 mA		8,800 Ω	43 H	73 H				

Note: 1. The rated current and coil resistance are measured at a coil temperature of 23°C with tolerances of +15%/–20% for AC rated current and ±15% for DC coil resistance.

2. The AC coil resistance and coil inductance values are for reference only.

3. Performance characteristic data is measured at a coil temperature of 23°C.

4. The maximum voltage is one that is applicable instantaneously to the Relay coil at 23°C and not continuously.

5. For built-in operation indicator models rated at 6, 12, and 24 VDC, add an LED current of approx. 5 mA to the rated currents.

■ Contact Ratings

Load	Resistive load ($\cos\phi = 1$)	Inductive load ($\cos\phi = 0.4$) (L/R = 7 ms)
Contact mechanism	Crossbar bifurcated	
Contact material	Movable:AgAu-clad AgPd Fixed:AgPd	
Rated load	0.3 A at 110 VAC 0.5 A at 24 VDC	0.2 A at 110 VAC 0.3 A at 24 VDC
Rated carry current	2 A	
Max. switching voltage	250 VAC, 125 VDC	
Max. switching current	AC: 0.7 A DC: 2 A	AC: 0.5 A DC: 1 A

■ Characteristics

Contact resistance (see note 2)	100 mΩ max.
Operate time (see note 3)	15 ms max.
Release time (see note 3)	15 ms max.
Max. operating frequency	Mechanical: 18,000 operations/hour Electrical: 1,800 operations/hour (under rated load)
Insulation resistance (see note 4)	100 MΩ min. (at 500 VDC)
Dielectric strength	1,500 VAC, 50/60 Hz for 1 minute between coil and contact and between contacts of different polarities (700 VAC between contacts of same polarities)
Vibration resistance	Destruction: 10 to 55 to 10 Hz, 0.75 mm single amplitude (1.5 mm double amplitude) Malfunction: 10 to 55 to 10 Hz, 0.5 mm single amplitude (1.0 mm double amplitude)
Shock resistance	Destruction: 1,000 m/s ² Malfunction: 100 m/s ²
Error rate (level P) (Reference value) (see note 5)	1 mA at 100 mVDC
Endurance	Mechanical: 100,000,000 operations min. (at operating frequency of 18,000 operations/hour) Electrical: 5,000,000 operations min. (under rated load and at operating frequency of 1,800 operations/hour) (see note 6)
Ambient temperature	Operating: -10°C to 40°C (with no icing or condensation)
Ambient humidity	Operating: 5% to 85%
Weight	Approx. 39 g

- Note:**
- The data shown above are initial values.
 - The contact resistance was measured with 0.1 A at 5 VDC using the voltage drop method.
 - The operate and release times were measured with the rated voltage imposed with any contact bounce ignored at an ambient temperature of 23°C.
 - The insulation resistance was measured with a 500-VDC megger applied to the same places as those used for checking the dielectric strength.
 - This value was measured at a switching frequency of 60 operations per minute.
 - The electrical endurance was measured at an ambient temperature of 23°C.

■ Approved by Standards

UL508 (File No. E41515)

Model	Coil ratings	Contact ratings
G2A-434A-US	6 to 120 VAC	1 A 120 VAC (resistive load)
G2A-4341P-US	6 to 120 VDC	1 A 30 VDC (inductive load)

Engineering Data

Maximum Switching Power

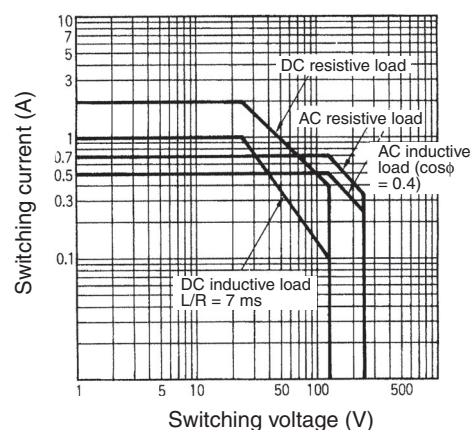

Endurance

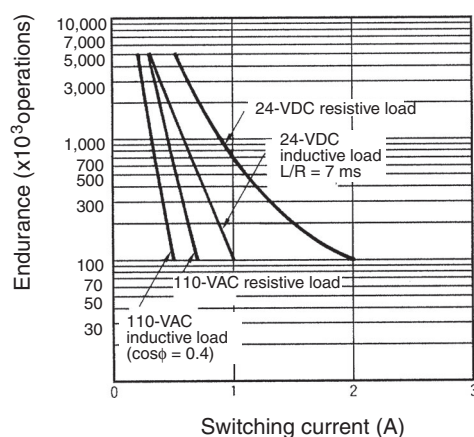

Ambient Temperature vs. Must-operate and Must-release Voltage

G2A-434A AC (60 Hz)

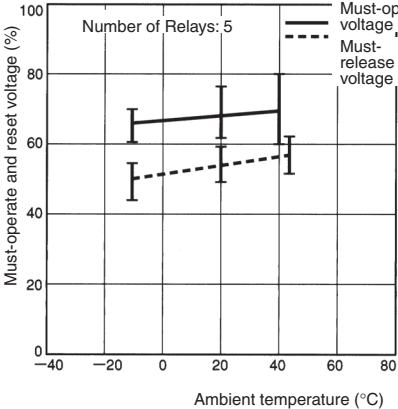

G2A-434A DC

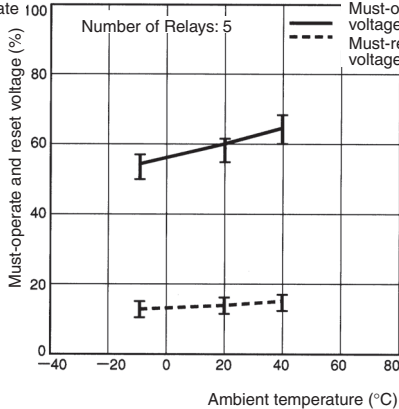

Malfunctioning Shock G2A-434A 100/110 VAC

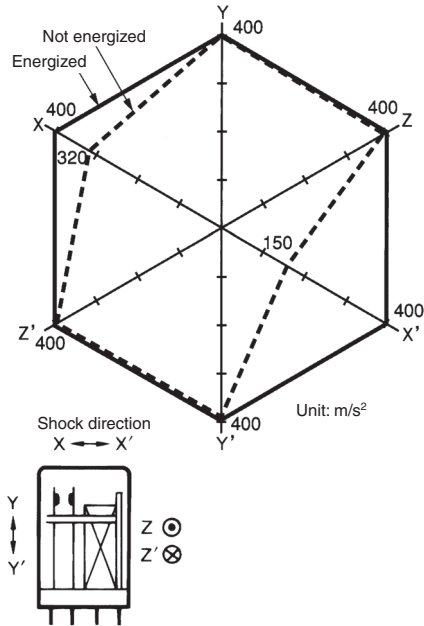

Number of samples: 5

Measurement conditions: Impose a shock of 100 m/s² in the ±X, ±Y, and ±Z directions three times each with the Relay energized and not energized to check the shock values that cause the Relay to malfunction.

H₂S Gas Data (Reference)

G2A-434A 24 VDC

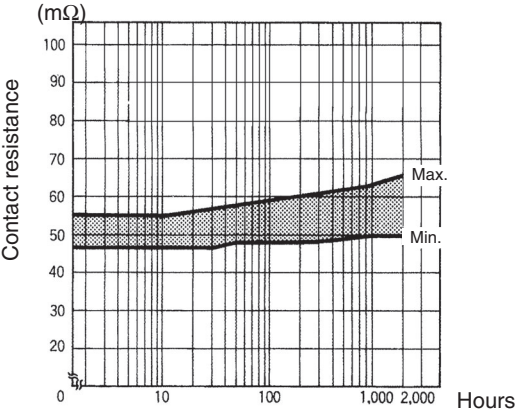

Measurement:

Sample is left in an atmosphere of H₂S gas with concentration of 2 to 5 ppm at 40°+5°/-0°C and at 75% to 80%, then taken out from the gas atmosphere at fixed time intervals, and left for 30 minutes or more at room temperature and humidity. The contact resistance values before and after the test are measured.

Dimensions

Note: 1. All units are in millimeters unless otherwise indicated.
 2. Dimensional tolerances are ± 0.1 mm.

Plug-in Terminal/Solder Terminal Models

G2A-434A (-US)
 G2A-434A-D
 G2A-434A-N (1)

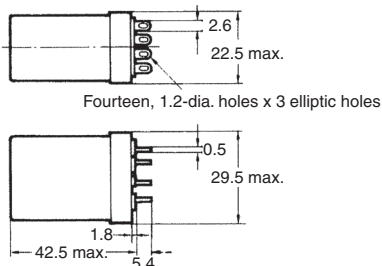
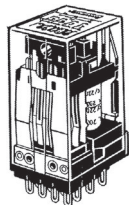

Terminal Arrangement/Internal Connections (Bottom View)

G2A-434A(-US)

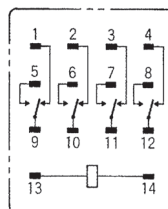

(No coil polarity)

G2A-434A-D

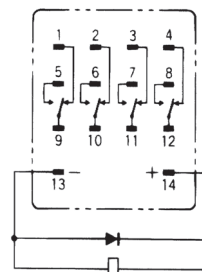

Be sure to wire the terminals with the correct polarity.

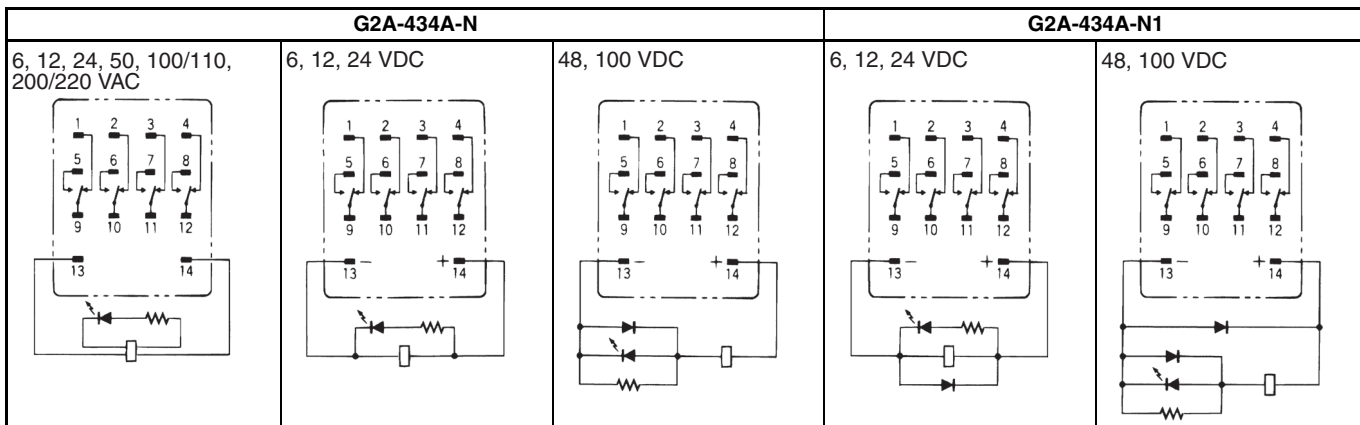

Operation indicator color
 AC model: Red
 DC model: Green

Note: DC models have coil polarity. Be sure to wire the terminals with the correct polarity.

PC Terminal Model

G2A-4341P (-US)

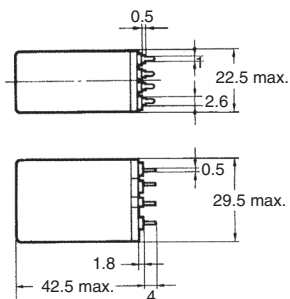
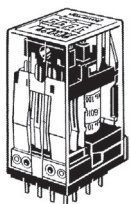

Mounting Holes on PCB (Bottom View)

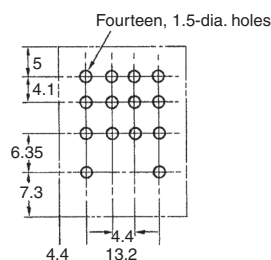

Terminal Arrangement (Bottom View)

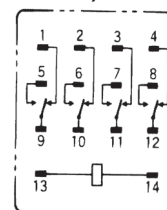

The coil has no polarity.

Safety Precautions

Refer to *Safety precautions for All Relays*.

DC models with a built-in indicator or built-in diode have coil polarity.
Be sure to wire the terminals with the correct polarity.

ALL DIMENSIONS SHOWN ARE IN MILLIMETERS.
To convert millimeters into inches, multiply by 0.03937. To convert grams into ounces, multiply by 0.03527.

In the interest of product improvement, specifications are subject to change without notice.

Read and Understand This Catalog

Please read and understand this catalog before purchasing the products. Please consult your OMRON representative if you have any questions or comments.

Warranty and Limitations of Liability

WARRANTY

OMRON's exclusive warranty is that the products are free from defects in materials and workmanship for a period of one year (or other period if specified) from date of sale by OMRON.

OMRON MAKES NO WARRANTY OR REPRESENTATION, EXPRESS OR IMPLIED, REGARDING NON-INFRINGEMENT, MERCHANTABILITY, OR FITNESS FOR PARTICULAR PURPOSE OF THE PRODUCTS. ANY BUYER OR USER ACKNOWLEDGES THAT THE BUYER OR USER ALONE HAS DETERMINED THAT THE PRODUCTS WILL SUITABLY MEET THE REQUIREMENTS OF THEIR INTENDED USE. OMRON DISCLAIMS ALL OTHER WARRANTIES, EXPRESS OR IMPLIED.

LIMITATIONS OF LIABILITY

OMRON SHALL NOT BE RESPONSIBLE FOR SPECIAL, INDIRECT, OR CONSEQUENTIAL DAMAGES, LOSS OF PROFITS OR COMMERCIAL LOSS IN ANY WAY CONNECTED WITH THE PRODUCTS, WHETHER SUCH CLAIM IS BASED ON CONTRACT, WARRANTY, NEGLIGENCE, OR STRICT LIABILITY.

In no event shall the responsibility of OMRON for any act exceed the individual price of the product on which liability is asserted.

IN NO EVENT SHALL OMRON BE RESPONSIBLE FOR WARRANTY, REPAIR, OR OTHER CLAIMS REGARDING THE PRODUCTS UNLESS OMRON'S ANALYSIS CONFIRMS THAT THE PRODUCTS WERE PROPERLY HANDLED, STORED, INSTALLED, AND MAINTAINED AND NOT SUBJECT TO CONTAMINATION, ABUSE, MISUSE, OR INAPPROPRIATE MODIFICATION OR REPAIR.

Application Considerations

SUITABILITY FOR USE

OMRON shall not be responsible for conformity with any standards, codes, or regulations that apply to the combination of products in the customer's application or use of the products.

At the customer's request, OMRON will provide applicable third party certification documents identifying ratings and limitations of use that apply to the products. This information by itself is not sufficient for a complete determination of the suitability of the products in combination with the end product, machine, system, or other application or use.

The following are some examples of applications for which particular attention must be given. This is not intended to be an exhaustive list of all possible uses of the products, nor is it intended to imply that the uses listed may be suitable for the products:

- Outdoor use, uses involving potential chemical contamination or electrical interference, or conditions or uses not described in this catalog.
- Nuclear energy control systems, combustion systems, railroad systems, aviation systems, medical equipment, amusement machines, vehicles, safety equipment, and installations subject to separate industry or government regulations.
- Systems, machines, and equipment that could present a risk to life or property.

Please know and observe all prohibitions of use applicable to the products.

NEVER USE THE PRODUCTS FOR AN APPLICATION INVOLVING SERIOUS RISK TO LIFE OR PROPERTY WITHOUT ENSURING THAT THE SYSTEM AS A WHOLE HAS BEEN DESIGNED TO ADDRESS THE RISKS, AND THAT THE OMRON PRODUCTS ARE PROPERLY RATED AND INSTALLED FOR THE INTENDED USE WITHIN THE OVERALL EQUIPMENT OR SYSTEM.

PROGRAMMABLE PRODUCTS

OMRON shall not be responsible for the user's programming of a programmable product, or any consequence thereof.

Disclaimers

CHANGE IN SPECIFICATIONS

Product specifications and accessories may be changed at any time based on improvements and other reasons.

It is our practice to change model numbers when published ratings or features are changed, or when significant construction changes are made. However, some specifications of the products may be changed without any notice. When in doubt, special model numbers may be assigned to fix or establish key specifications for your application on your request. Please consult with your OMRON representative at any time to confirm actual specifications of purchased products.

DIMENSIONS AND WEIGHTS

Dimensions and weights are nominal and are not to be used for manufacturing purposes, even when tolerances are shown.

PERFORMANCE DATA

Performance data given in this catalog is provided as a guide for the user in determining suitability and does not constitute a warranty. It may represent the result of OMRON's test conditions, and the users must correlate it to actual application requirements. Actual performance is subject to the OMRON Warranty and Limitations of Liability.

ERRORS AND OMISSIONS

The information in this document has been carefully checked and is believed to be accurate; however, no responsibility is assumed for clerical, typographical, or proofreading errors, or omissions.

2008.12

In the interest of product improvement, specifications are subject to change without notice.

OMRON Corporation
Industrial Automation Company

<http://www.ia.omron.com/>

(c)Copyright OMRON Corporation 2008 All Right Reserved.