

DAC124S085 12-Bit Micro Power QUAD Digital-to-Analog Converter with Rail-to-Rail Output

Check for Samples: [DAC124S085](#)

FEATURES

- Ensured Monotonicity
- Low Power Operation
- Rail-to-Rail Voltage Output
- Power-on Reset to 0V
- Simultaneous Output Updating
- Wide Power Supply Range (+2.7V to +5.5V)
- Industry's Smallest Package
- Power Down Modes

APPLICATIONS

- Battery-Powered Instruments
- Digital Gain and Offset Adjustment
- Programmable Voltage & Current Sources
- Programmable Attenuators

KEY SPECIFICATIONS

- Resolution: 12 Bits
- INL: ± 8 LSB (Max)
- DNL: $+0.7 / -0.5$ LSB (Max)
- Setting Time: 8.5 μ s (Max)
- Zero Code Error: $+15$ mV (Max)
- Full-Scale Error: -0.75 %FS (Max)
- Supply Power:
 - Normal: 1.1 mW (3V) / 2.4 mW (5V) Typ
 - Power Down: 0.3 μ W (3V) / 0.8 μ W (5V) Typ

DESCRIPTION

The DAC124S085 is a full-featured, general purpose QUAD 12-bit voltage-output digital-to-analog converter (DAC) that can operate from a single +2.7V to 5.5V supply and consumes 1.1 mW at 3V and 2.4 mW at 5V. The DAC124S085 is packaged in 10-lead SON and VSSOP packages.

The 10-lead SON package makes the DAC124S085 the smallest QUAD DAC in its class. The on-chip output amplifier allows rail-to-rail output swing and the three wire serial interface operates at clock rates up to 40 MHz over the entire supply voltage range. Competitive devices are limited to 25 MHz clock rates at supply voltages in the 2.7V to 3.6V range. The serial interface is compatible with standard SPI, QSPI, MICROWIRE and DSP interfaces.

The reference for the DAC124S085 serves all four channels and can vary in voltage between 1V and V_A , providing the widest possible output dynamic range. The DAC124S085 has a 16-bit input shift register that controls the outputs to be updated, the mode of operation, the powerdown condition, and the binary input data. All four outputs can be updated simultaneously or individually depending on the setting of the two mode of operation bits.

A power-on reset circuit ensures that the DAC output powers up to zero volts and remains there until there is a valid write to the device. A power-down feature reduces power consumption to less than a microWatt with three different termination options.

The low power consumption and small packages of the DAC124S085 make it an excellent choice for use in battery operated equipment.

The DAC124S085 is one of a family of pin compatible DACs, including the 8-bit DAC084S085 and the 10-bit DAC104S085. The DAC124S085 operates over the extended industrial temperature range of -40°C to $+105^{\circ}\text{C}$.

Pin Configuration

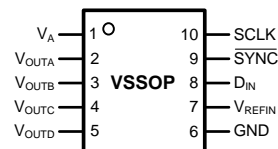
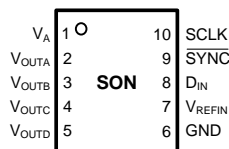

Please be aware that an important notice concerning availability, standard warranty, and use in critical applications of Texas Instruments semiconductor products and disclaimers thereto appears at the end of this data sheet.

All trademarks are the property of their respective owners.

Block Diagram

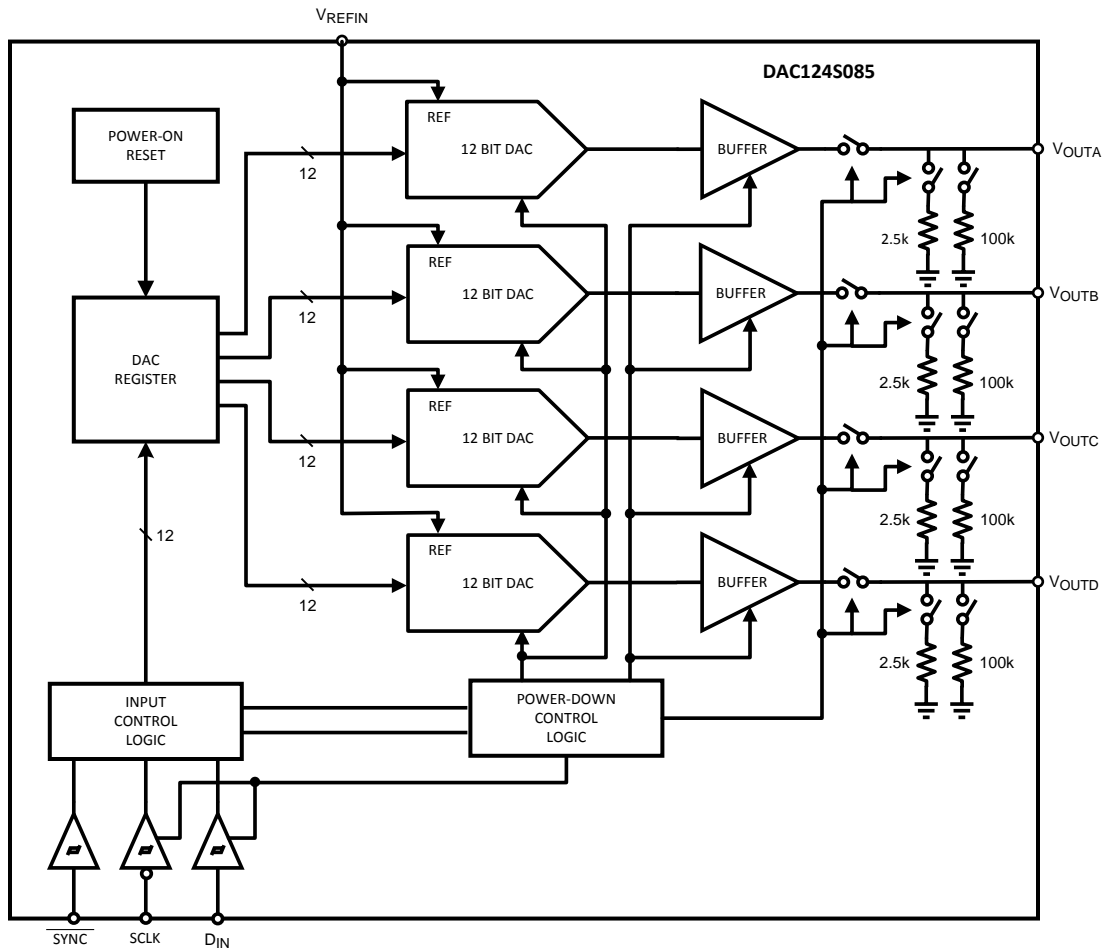

Pin Descriptions

SON VSSOP Pin No.	Symbol	Type	Description
1	V_A	Supply	Power supply input. Must be decoupled to GND.
2	V_{OUTA}	Analog Output	Channel A Analog Output Voltage.
3	V_{OUTB}	Analog Output	Channel B Analog Output Voltage.
4	V_{OUTC}	Analog Output	Channel C Analog Output Voltage.
5	V_{OUTD}	Analog Output	Channel D Analog Output Voltage.
6	GND	Ground	Ground reference for all on-chip circuitry.
7	V_{REFIN}	Analog Input	Unbuffered reference voltage shared by all channels. Must be decoupled to GND.
8	D_{IN}	Digital Input	Serial Data Input. Data is clocked into the 16-bit shift register on the falling edges of SCLK after the fall of SYNC.
9	\overline{SYNC}	Digital Input	Frame synchronization input for the data input. When this pin goes low, it enables the input shift register and data is transferred on the falling edges of SCLK. The DAC is updated on the 16th clock cycle unless SYNC is brought high before the 16th clock, in which case the rising edge of SYNC acts as an interrupt and the write sequence is ignored by the DAC.
10	SCLK	Digital Input	Serial Clock Input. Data is clocked into the input shift register on the falling edges of this pin.
11	PAD (SON only)	Ground	Exposed die attach pad can be connected to ground or left floating. Soldering the pad to the PCB offers optimal thermal performance and enhances package self-alignment during reflow.



These devices have limited built-in ESD protection. The leads should be shorted together or the device placed in conductive foam during storage or handling to prevent electrostatic damage to the MOS gates.

Absolute Maximum Ratings⁽¹⁾⁽²⁾⁽³⁾

Supply Voltage, V_A		6.5V
Voltage on any Input Pin		-0.3V to 6.5V
Input Current at Any Pin ⁽⁴⁾		10 mA
Package Input Current ⁽⁴⁾		20 mA
Power Consumption at $T_A = 25^\circ\text{C}$		See ⁽⁵⁾
ESD Susceptibility ⁽⁶⁾	Human Body Model	2500V
	Machine Model	250V
Junction Temperature		+150°C
Storage Temperature		-65°C to +150°C

- (1) Absolute Maximum Ratings indicate limits beyond which damage to the device may occur. Operating Ratings indicate conditions for which the device is functional, but do not ensure specific performance limits. For ensured specifications and test conditions, see the Electrical Characteristics. The ensured specifications apply only for the test conditions listed. Some performance characteristics may degrade when the device is not operated under the listed test conditions. Operation of the device beyond the maximum Operating Ratings is not recommended.
- (2) All voltages are measured with respect to GND = 0V, unless otherwise specified.
- (3) If Military/Aerospace specified devices are required, please contact the Texas Instruments Sales Office/Distributors for availability and specifications.
- (4) When the input voltage at any pin exceeds 5.5V or is less than GND, the current at that pin should be limited to 10 mA. The 20 mA maximum package input current rating limits the number of pins that can safely exceed the power supplies with an input current of 10 mA to two.
- (5) The absolute maximum junction temperature (T_{Jmax}) for this device is 150°C. The maximum allowable power dissipation is dictated by T_{Jmax} , the junction-to-ambient thermal resistance (θ_{JA}), and the ambient temperature (T_A), and can be calculated using the formula $P_{DMAX} = (T_{Jmax} - T_A) / \theta_{JA}$. The values for maximum power dissipation will be reached only when the device is operated in a severe fault condition (e.g., when input or output pins are driven beyond the operating ratings, or the power supply polarity is reversed).
- (6) Human body model is 100 pF capacitor discharged through a 1.5 kΩ resistor. Machine model is 220 pF discharged through ZERO Ohms.

Operating Ratings⁽¹⁾⁽²⁾

Operating Temperature Range		$-40^\circ\text{C} \leq T_A \leq +105^\circ\text{C}$
Supply Voltage, V_A		+2.7V to 5.5V
Reference Voltage, V_{REFIN}		+1.0V to V_A
Digital Input Voltage ⁽³⁾		0.0V to 5.5V
Output Load		0 to 1500 pF
SCLK Frequency		Up to 40 MHz

- (1) Absolute Maximum Ratings indicate limits beyond which damage to the device may occur. Operating Ratings indicate conditions for which the device is functional, but do not ensure specific performance limits. For ensured specifications and test conditions, see the Electrical Characteristics. The ensured specifications apply only for the test conditions listed. Some performance characteristics may degrade when the device is not operated under the listed test conditions. Operation of the device beyond the maximum Operating Ratings is not recommended.
- (2) All voltages are measured with respect to GND = 0V, unless otherwise specified.
- (3) The inputs are protected as shown below. Input voltage magnitudes up to 5.5V, regardless of V_A , will not cause errors in the conversion result. For example, if V_A is 3V, the digital input pins can be driven with a 5V logic device.

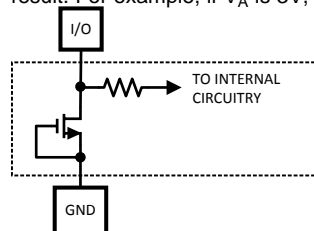

Package Thermal Resistances⁽¹⁾⁽²⁾

Package	θ_{JA}
10-Lead VSSOP	240°C/W
10-Lead SON	250°C/W

- (1) Soldering process must comply with Texas Instruments' Reflow Temperature Profile specifications. Refer to <http://www.ti.com/lit/SNOA549>
- (2) Reflow temperature profiles are different for lead-free packages.

Electrical Characteristics

The following specifications apply for $V_A = +2.7V$ to $+5.5V$, $V_{REFIN} = V_A$, $C_L = 200$ pF to GND, $f_{SCLK} = 30$ MHz, input code range 48 to 4047. **Boldface limits apply for $T_{MIN} \leq T_A \leq T_{MAX}$** and all other limits are at $T_A = 25^\circ C$, unless otherwise specified.

Symbol	Parameter	Conditions	Typical ⁽¹⁾	Limits ⁽¹⁾	Units (Limits)
STATIC PERFORMANCE					
	Resolution			12	Bits (min)
	Monotonicity			12	Bits (min)
INL	Integral Non-Linearity		± 2.4	± 8	LSB (max)
DNL	Differential Non-Linearity	$V_A = 2.7V$ to $5.5V$	+0.2	+0.7	LSB (max)
		$V_A = 4.5V$ to $5.5V$ ⁽²⁾	-0.1	-0.5	LSB (min)
			± 0.15	± 0.5	LSB (max)
ZE	Zero Code Error	$I_{OUT} = 0$	+4	+15	mV (max)
FSE	Full-Scale Error	$I_{OUT} = 0$	-0.1	-0.75	%FSR (max)
GE	Gain Error	All ones Loaded to DAC register	-0.2	-1.0	%FSR
ZCED	Zero Code Error Drift		-20		$\mu V/^\circ C$
TC GE	Gain Error Tempco	$V_A = 3V$	-0.7		ppm/ $^\circ C$
		$V_A = 5V$	-1.0		ppm/ $^\circ C$
OUTPUT CHARACTERISTICS					
	Output Voltage Range	See ⁽²⁾		0 V_{REFIN}	V (min) V (max)
I_{OZ}	High-Impedance Output Leakage Current ⁽²⁾			± 1	μA (max)
ZCO	Zero Code Output	$V_A = 3V$, $I_{OUT} = 200 \mu A$	1.3		mV
		$V_A = 3V$, $I_{OUT} = 1$ mA	6.0		mV
		$V_A = 5V$, $I_{OUT} = 200 \mu A$	7.0		mV
		$V_A = 5V$, $I_{OUT} = 1$ mA	10.0		mV
FSO	Full Scale Output	$V_A = 3V$, $I_{OUT} = 200 \mu A$	2.984		V
		$V_A = 3V$, $I_{OUT} = 1$ mA	2.934		V
		$V_A = 5V$, $I_{OUT} = 200 \mu A$	4.989		V
		$V_A = 5V$, $I_{OUT} = 1$ mA	4.958		V
I_{OS}	Output Short Circuit Current (source)	$V_A = 3V$, $V_{OUT} = 0V$, Input Code = FFFh	-56		mA
		$V_A = 5V$, $V_{OUT} = 0V$, Input Code = FFFh	-69		mA
I_{OS}	Output Short Circuit Current (sink)	$V_A = 3V$, $V_{OUT} = 3V$, Input Code = 000h	52		mA
		$V_A = 5V$, $V_{OUT} = 5V$, Input Code = 000h	75		mA
I_O	Continuous Output Current ⁽²⁾	Available on each DAC output		11	mA (max)
C_L	Maximum Load Capacitance	$R_L = \infty$	1500		pF
		$R_L = 2k\Omega$	1500		pF
Z_{OUT}	DC Output Impedance		7.5		Ω

- (1) Typical figures are at $T_J = 25^\circ C$, and represent most likely parametric norms. Test limits are ensured to AOQL (Average Outgoing Quality Level).
- (2) This parameter is ensured by design and/or characterization and is not tested in production.

Electrical Characteristics (continued)

The following specifications apply for $V_A = +2.7V$ to $+5.5V$, $V_{REFIN} = V_A$, $C_L = 200$ pF to GND, $f_{SCLK} = 30$ MHz, input code range 48 to 4047. **Boldface limits apply for $T_{MIN} \leq T_A \leq T_{MAX}$** and all other limits are at $T_A = 25^\circ C$, unless otherwise specified.

Symbol	Parameter	Conditions	Typical ⁽¹⁾	Limits ⁽¹⁾	Units (Limits)	
REFERENCE INPUT CHARACTERISTICS						
$V_{REFIN}^{(3)}$	Input Range Minimum		0.2	1.0	V (min)	
	Input Range Maximum			V_A	V (max)	
	Input Impedance		30		k Ω	
LOGIC INPUT CHARACTERISTICS						
I_{IN}	Input Current ⁽²⁾			± 1	μA (max)	
V_{IL}	Input Low Voltage ⁽²⁾	$V_A = 3V$	0.9	0.6	V (max)	
		$V_A = 5V$	1.5	0.8	V (max)	
V_{IH}	Input High Voltage ⁽²⁾	$V_A = 3V$	1.4	2.1	V (min)	
		$V_A = 5V$	2.1	2.4	V (min)	
C_{IN}	Input Capacitance ⁽²⁾			3	pF (max)	
POWER REQUIREMENTS						
$V_A^{(3)}$	Supply Voltage Minimum			2.7	V (min)	
	Supply Voltage Maximum			5.5	V (max)	
I_N	Normal Supply Current (output unloaded)	$f_{SCLK} = 30$ MHz	$V_A = 2.7V$ to $3.6V$	360	485	μA (max)
			$V_A = 4.5V$ to $5.5V$	480	650	μA (max)
		$f_{SCLK} = 0$	$V_A = 2.7V$ to $3.6V$	330		μA
			$V_A = 4.5V$ to $5.5V$	440		μA
I_{PD}	Power Down Supply Current (output unloaded, SYNC = DIN = 0V after PD mode loaded)	All PD Modes ⁽⁴⁾	$V_A = 2.7V$ to $3.6V$	0.10	1.0	μA (max)
			$V_A = 4.5V$ to $5.5V$	0.15	1.0	μA (max)
P_N	Normal Supply Power (output unloaded)	$f_{SCLK} = 30$ MHz	$V_A = 2.7V$ to $3.6V$	1.1	1.7	mW (max)
			$V_A = 4.5V$ to $5.5V$	2.4	3.6	mW (max)
		$f_{SCLK} = 0$	$V_A = 2.7V$ to $3.6V$	1.0		mW
			$V_A = 4.5V$ to $5.5V$	2.2		mW
P_{PD}	Power Down Supply Power (output unloaded, SYNC = DIN = 0V after PD mode loaded)	All PD Modes ⁽⁴⁾	$V_A = 2.7V$ to $3.6V$	0.3	3.6	μW (max)
			$V_A = 4.5V$ to $5.5V$	0.8	5.5	μW (max)

(3) To ensure accuracy, it is required that V_A and V_{REFIN} be well bypassed.

(4) This parameter is ensured by design and/or characterization and is not tested in production.

A.C. and Timing Characteristics

Values shown in this table are design targets and are subject to change before product release.

The following specifications apply for $V_A = +2.7V$ to $+5.5V$, $V_{REFIN} = V_A$, $C_L = 200$ pF to GND, $f_{SCLK} = 30$ MHz, input code range 48 to 4047. **Boldface limits apply for $T_{MIN} \leq T_A \leq T_{MAX}$** and all other limits are at $T_A = 25^\circ C$, unless otherwise specified.

Symbol	Parameter	Conductions	Typical ⁽¹⁾	Limits ⁽¹⁾	Units (Limits)
f_{SCLK}	SCLK Frequency		40	30	MHz (max)
t_s	Output Voltage Settling Time ⁽²⁾	400h to C00h code change $R_L = 2k\Omega$, $C_L = 200$ pF	6	8.5	μs (max)
SR	Output Slew Rate		1		V/ μs
	Glitch Impulse	Code change from 800h to 7FFh	12		nV-sec
	Digital Feedthrough		0.5		nV-sec
	Digital Crosstalk		1		nV-sec
	DAC-to-DAC Crosstalk		3		nV-sec
	Multiplying Bandwidth	$V_{REFIN} = 2.5V \pm 0.1V_{pp}$	160		kHz
	Total Harmonic Distortion	$V_{REFIN} = 2.5V \pm 0.1V_{pp}$ input frequency = 10kHz	70		dB
t_{WU}	Wake-Up Time	$V_A = V_{REF} = 3V$	6		μsec
		$V_A = V_{REF} = 5V$	39		μsec
$1/f_{SCLK}$	SCLK Cycle Time		25	33	ns (min)
t_{CH}	SCLK High time		7	10	ns (min)
t_{CL}	SCLK Low Time		7	10	ns (min)
t_{SS}	\overline{SYNC} Set-up Time prior to SCLK Falling Edge		4	10	ns (min)
t_{DS}	Data Set-Up Time prior to SCLK Falling Edge		1.5	3.5	ns (min)
t_{DH}	Data Hold Time after SCLK Falling Edge		1.5	3.5	ns (min)
t_{CFSR}	SCLK fall prior to rise of \overline{SYNC}		0	3	ns (min)
t_{SYNC}	\overline{SYNC} High Time		6	10	ns (min)

(1) Typical figures are at $T_J = 25^\circ C$, and represent most likely parametric norms. Test limits are ensured to AOQL (Average Outgoing Quality Level).

(2) This parameter is ensured by design and/or characterization and is not tested in production.

Specification Definitions

DIFFERENTIAL NON-LINEARITY (DNL) is the measure of the maximum deviation from the ideal step size of 1 LSB, which is $V_{REF} / 4096 = V_A / 4096$.

DAC-to-DAC CROSSTALK is the glitch impulse transferred to a DAC output in response to a full-scale change in the output of another DAC.

DIGITAL CROSSTALK is the glitch impulse transferred to a DAC output at mid-scale in response to a full-scale change in the input register of another DAC.

DIGITAL FEEDTHROUGH is a measure of the energy injected into the analog output of the DAC from the digital inputs when the DAC outputs are not updated. It is measured with a full-scale code change on the data bus.

FULL-SCALE ERROR is the difference between the actual output voltage with a full scale code (FFFh) loaded into the DAC and the value of $V_A \times 4095 / 4096$.

GAIN ERROR is the deviation from the ideal slope of the transfer function. It can be calculated from Zero and Full-Scale Errors as $GE = FSE - ZE$, where GE is Gain error, FSE is Full-Scale Error and ZE is Zero Error.

GLITCH IMPULSE is the energy injected into the analog output when the input code to the DAC register changes. It is specified as the area of the glitch in nanovolt-seconds.

INTEGRAL NON-LINEARITY (INL) is a measure of the deviation of each individual code from a straight line through the input to output transfer function. The deviation of any given code from this straight line is measured from the center of that code value. The end point method is used. INL for this product is specified over a limited range, per the Electrical Tables.

LEAST SIGNIFICANT BIT (LSB) is the bit that has the smallest value or weight of all bits in a word. This value is

$$LSB = V_{REF} / 2^n$$

where

- V_{REF} is the supply voltage for this product
 - "n" is the DAC resolution in bits, which is 12 for the DAC124S085
- (1)

MAXIMUM LOAD CAPACITANCE is the maximum capacitance that can be driven by the DAC with output stability maintained.

MONOTONICITY is the condition of being monotonic, where the DAC has an output that never decreases when the input code increases.

MOST SIGNIFICANT BIT (MSB) is the bit that has the largest value or weight of all bits in a word. Its value is $1/2$ of V_A .

MULTIPLYING BANDWIDTH is the frequency at which the output amplitude falls 3dB below the input sine wave on V_{REFIN} with a full-scale code loaded into the DAC.

POWER EFFICIENCY is the ratio of the output current to the total supply current. The output current comes from the power supply. The difference between the supply and output currents is the power consumed by the device without a load.

SETTLING TIME is the time for the output to settle to within $1/2$ LSB of the final value after the input code is updated.

TOTAL HARMONIC DISTORTION (THD) is the measure of the harmonics present at the output of the DACs with an ideal sine wave applied to V_{REFIN} . THD is measured in dB.

WAKE-UP TIME is the time for the output to exit power-down mode. This is the time from the falling edge of the 16th SCLK pulse to when the output voltage deviates from the power-down voltage of 0V.

ZERO CODE ERROR is the output error, or voltage, present at the DAC output after a code of 000h has been entered.

Transfer Characteristic

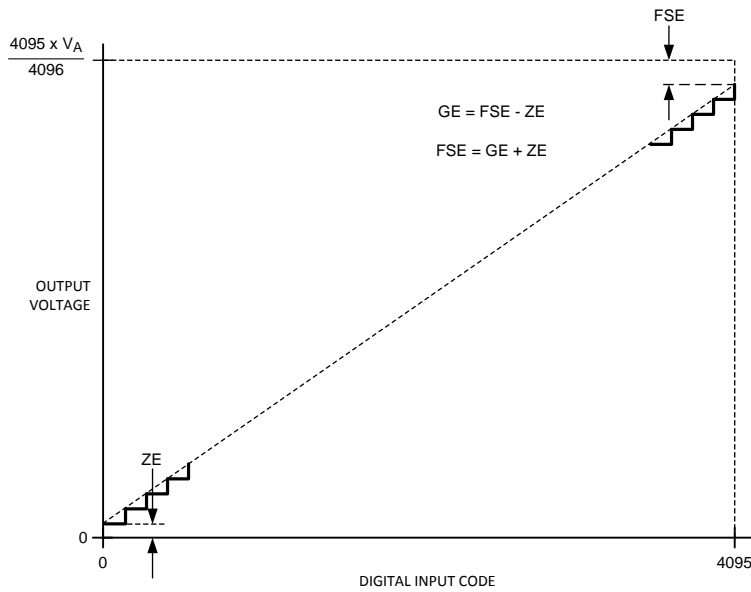

Figure 1. Input / Output Transfer Characteristic

Timing Diagrams

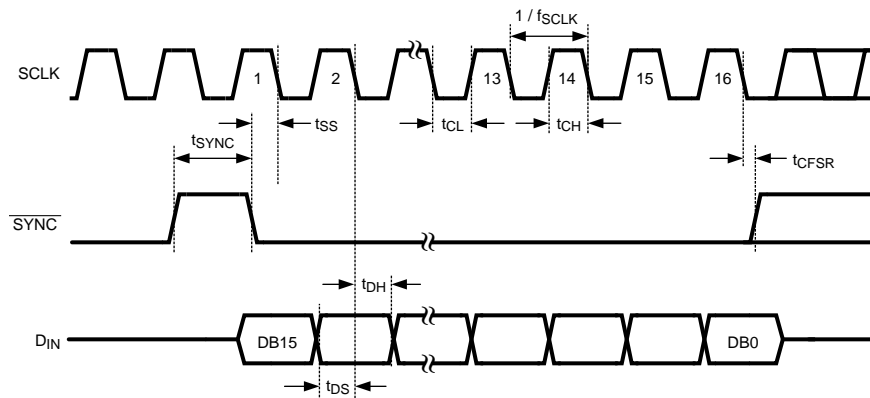

Figure 2. Serial Timing Diagram

Typical Performance Characteristics

$V_{REF} = V_A$, $f_{SCLK} = 30$ MHz, $T_A = 25^\circ\text{C}$, Input Code Range 48 to 4047, unless otherwise stated

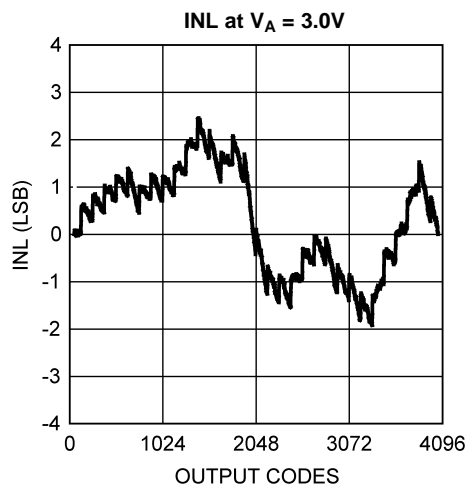

Figure 3.

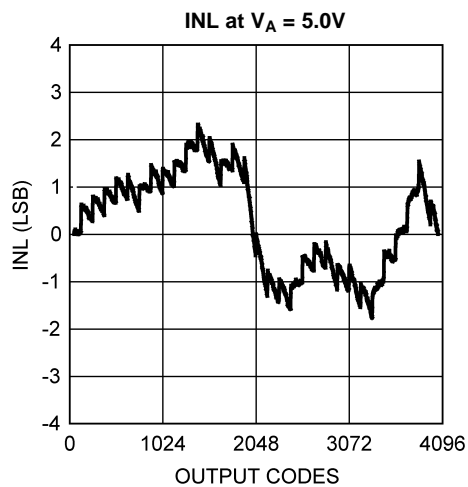

Figure 4.

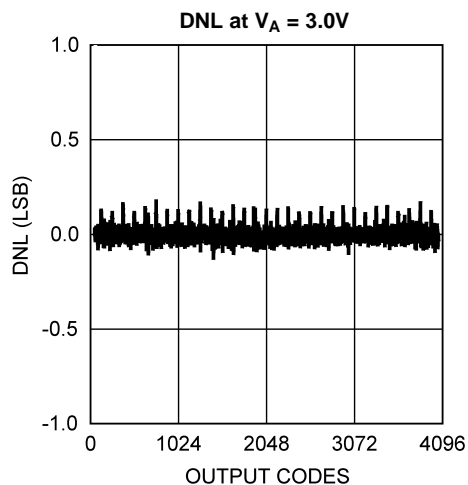

Figure 5.

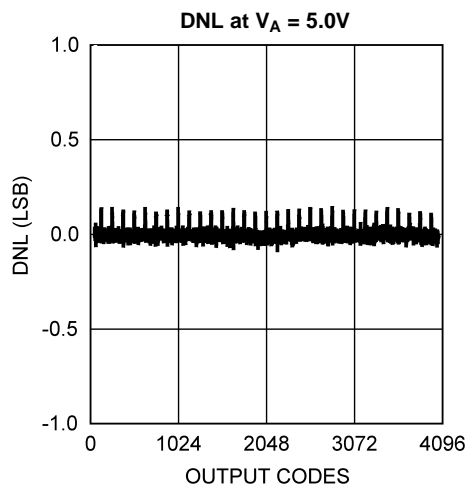

Figure 6.

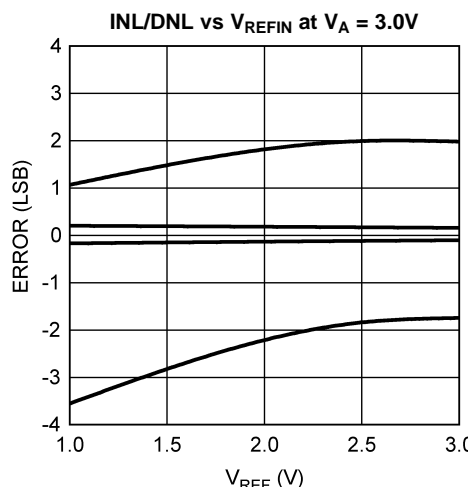

Figure 7.

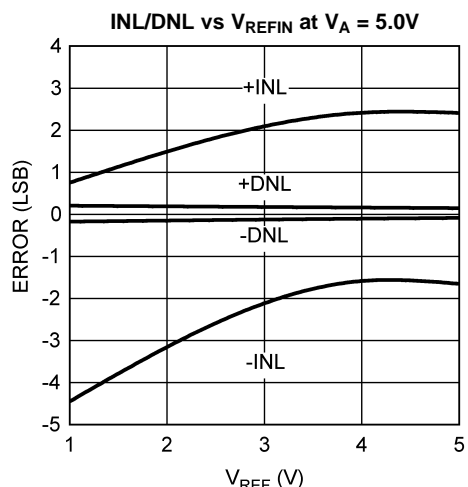

Figure 8.

Typical Performance Characteristics (continued)

$V_{REF} = V_A$, $f_{SCLK} = 30$ MHz, $T_A = 25^\circ\text{C}$, Input Code Range 48 to 4047, unless otherwise stated

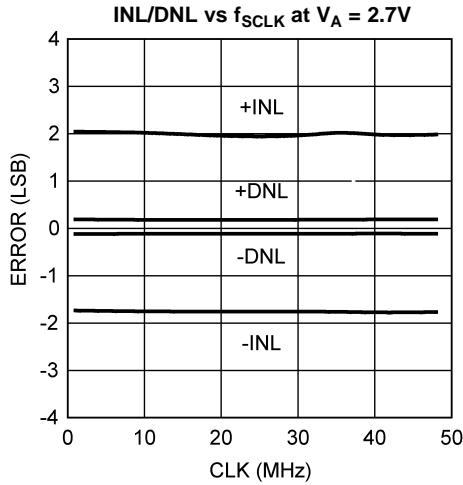

Figure 9.

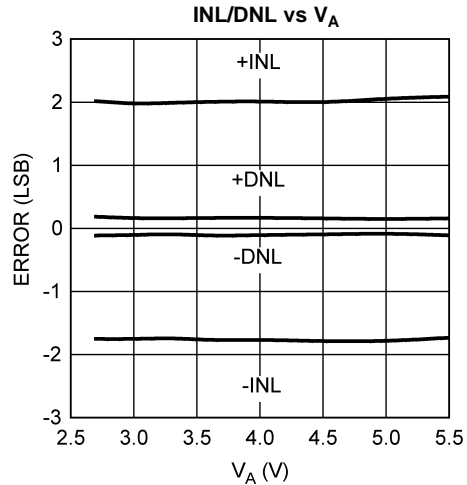

Figure 10.

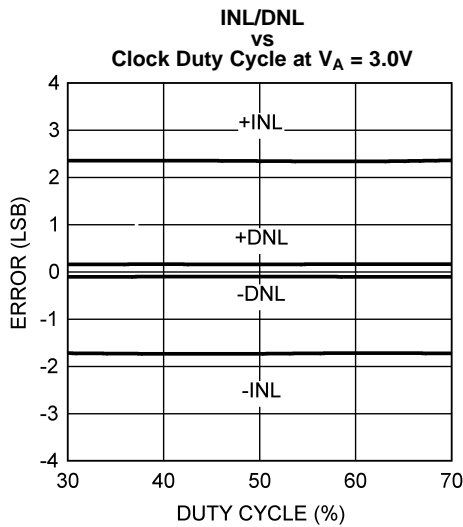

Figure 11.

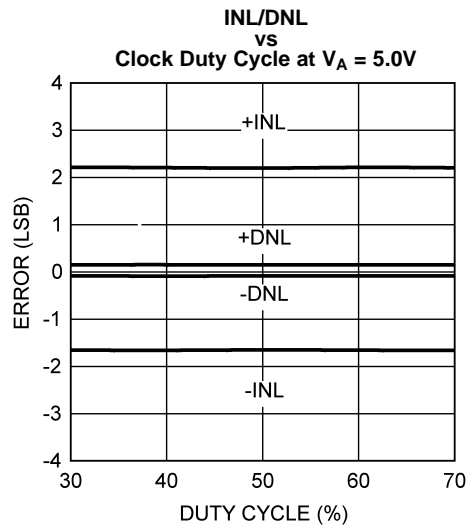

Figure 12.

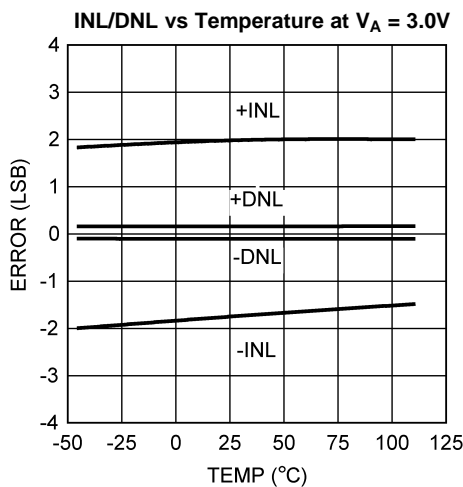

Figure 13.

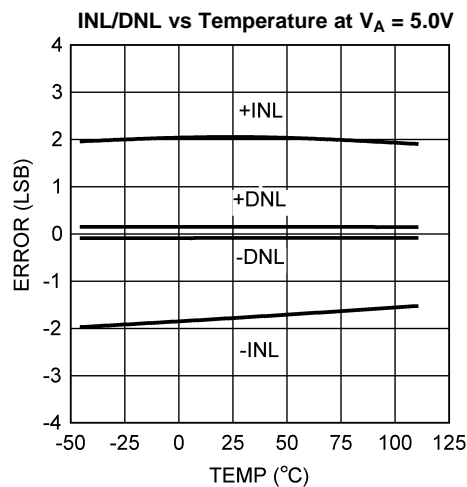

Figure 14.

Typical Performance Characteristics (continued)

$V_{REF} = V_A$, $f_{SCLK} = 30$ MHz, $T_A = 25^\circ\text{C}$, Input Code Range 48 to 4047, unless otherwise stated

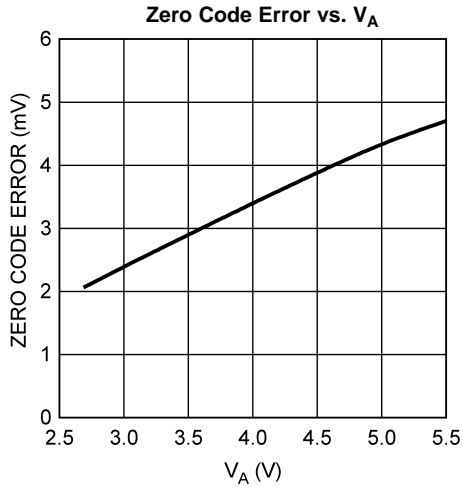

Figure 15.

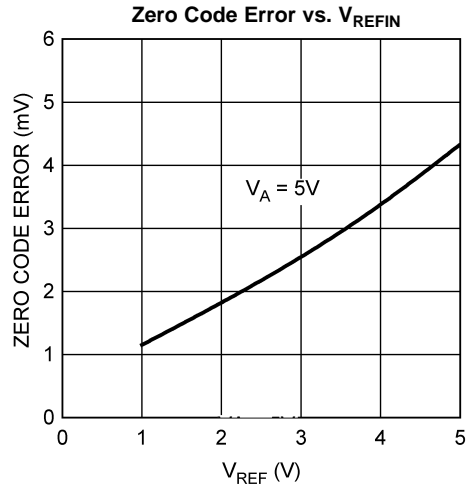

Figure 16.

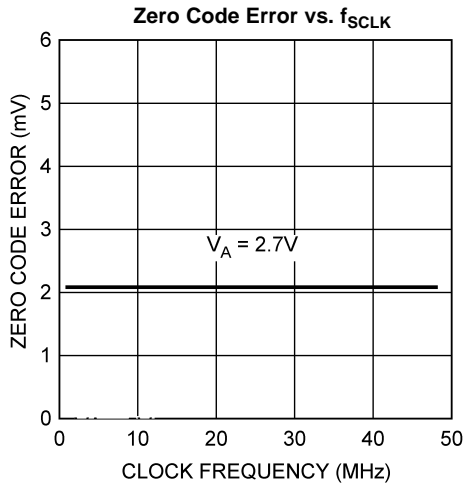

Figure 17.

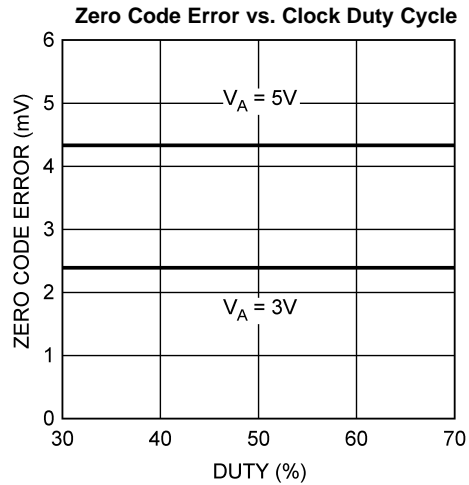

Figure 18.

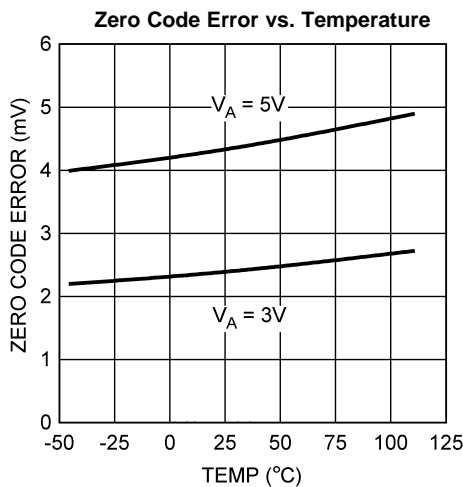

Figure 19.

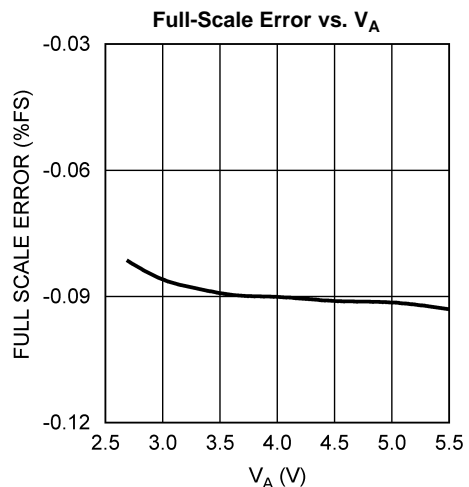

Figure 20.

Typical Performance Characteristics (continued)

$V_{REF} = V_A$, $f_{SCLK} = 30$ MHz, $T_A = 25^\circ\text{C}$, Input Code Range 48 to 4047, unless otherwise stated

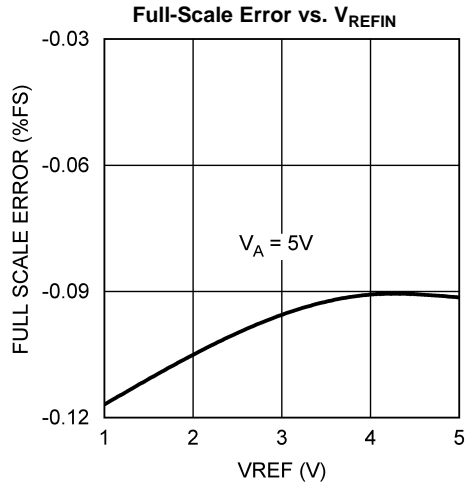

Figure 21.

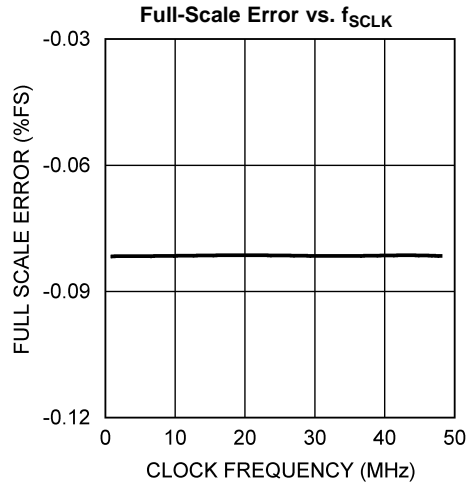

Figure 22.

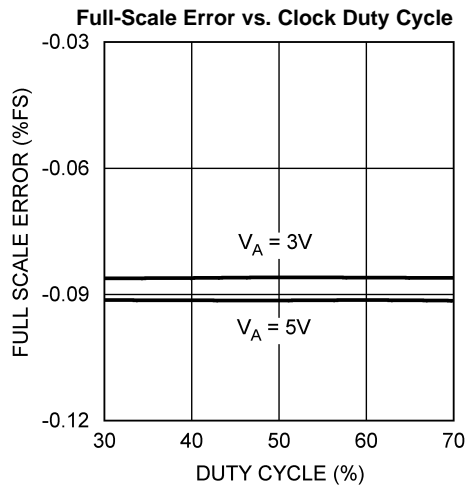

Figure 23.

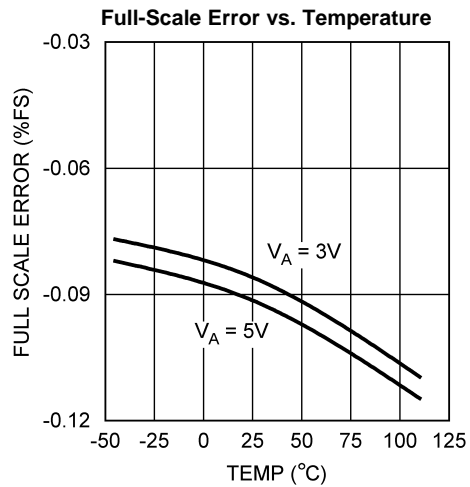

Figure 24.

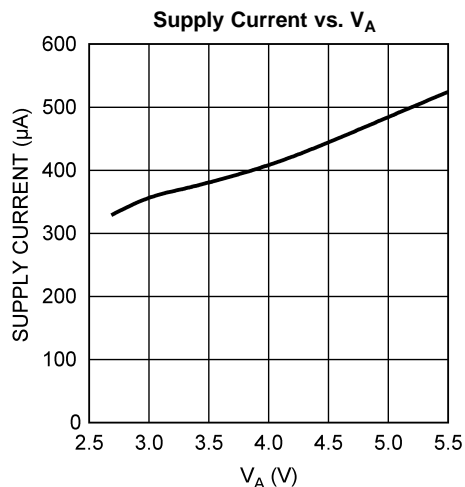

Figure 25.

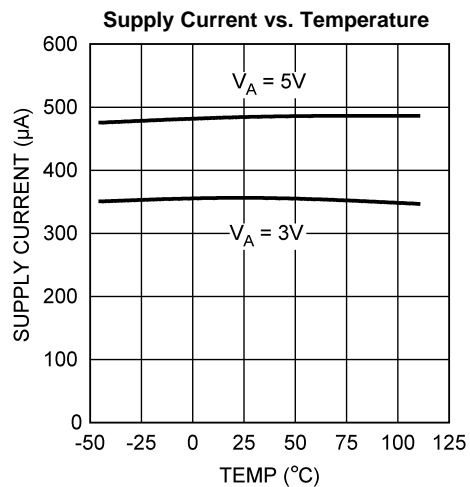

Figure 26.

Typical Performance Characteristics (continued)

$V_{REF} = V_A$, $f_{SCLK} = 30$ MHz, $T_A = 25$ °C, Input Code Range 48 to 4047, unless otherwise stated

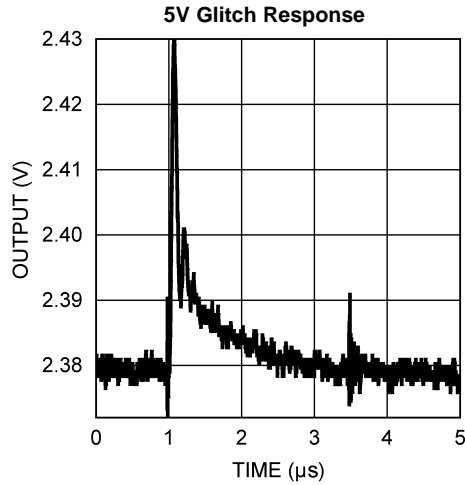

Figure 27.

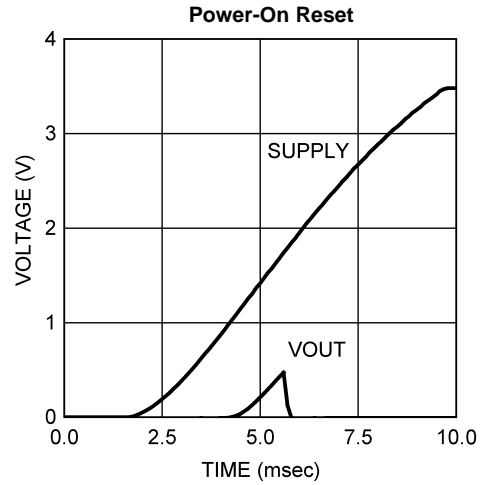

Figure 28.

Functional Description

DAC SECTION

The DAC124S085 is fabricated on a CMOS process with an architecture that consists of switches and resistor strings that are followed by an output buffer. The reference voltage is externally applied at V_{REFIN} and is shared by all four DACs.

For simplicity, a single resistor string is shown in Figure 29. This string consists of 4096 equal valued resistors with a switch at each junction of two resistors, plus a switch to ground. The code loaded into the DAC register determines which switch is closed, connecting the proper node to the amplifier. The input coding is straight binary with an ideal output voltage of:

$$V_{OUTA,B,C,D} = V_{REFIN} \times (D / 4096)$$

where

- D is the decimal equivalent of the binary code that is loaded into the DAC register) (2)

D can take on any value between 0 and 4095. This configuration ensures that the DAC is monotonic.

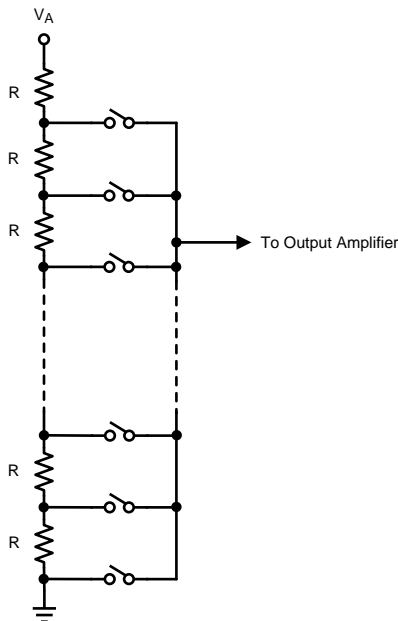

Figure 29. DAC Resistor String

OUTPUT AMPLIFIERS

The output amplifiers are rail-to-rail, providing an output voltage range of 0V to V_A when the reference is V_A . All amplifiers, even rail-to-rail types, exhibit a loss of linearity as the output approaches the supply rails (0V and V_A , in this case). For this reason, linearity is specified over less than the full output range of the DAC. However, if the reference is less than V_A , there is only a loss in linearity in the lowest codes. The output capabilities of the amplifier are described in the Electrical Tables.

The output amplifiers are capable of driving a load of 2 k Ω in parallel with 1500 pF to ground or to V_A . The zero-code and full-scale outputs for given load currents are available in the Electrical Characteristics Table.

REFERENCE VOLTAGE

The DAC124S085 uses a single external reference that is shared by all four channels. The reference pin, V_{REFIN} , is not buffered and has an input impedance of 30 k Ω . It is recommended that V_{REFIN} be driven by a voltage source with low output impedance. The reference voltage range is 1.0V to V_A , providing the widest possible output dynamic range.

SERIAL INTERFACE

The three-wire interface is compatible with SPI, QSPI and MICROWIRE, as well as most DSPs and operates at clock rates up to 40 MHz. See the Timing Diagram for information on a write sequence.

A write sequence begins by bringing the \overline{SYNC} line low. Once \overline{SYNC} is low, the data on the D_{IN} line is clocked into the 16-bit serial input register on the falling edges of SCLK. To avoid misclocking data into the shift register, it is critical that \overline{SYNC} not be brought low simultaneously with a falling edge of SCLK (see Serial Timing Diagram, Figure 2). On the 16th falling clock edge, the last data bit is clocked in and the programmed function (a change in the DAC channel address, mode of operation and/or register contents) is executed. At this point the SYNC line may be kept low or brought high. Any data and clock pulses after the 16th falling clock edge will be ignored. In either case, \overline{SYNC} must be brought high for the minimum specified time before the next write sequence is initiated with a falling edge of \overline{SYNC} .

Since the \overline{SYNC} and D_{IN} buffers draw more current when they are high, they should be idled low between write sequences to minimize power consumption.

INPUT SHIFT REGISTER

The input shift register, [Figure 30](#), has sixteen bits. The first two bits are address bits. They determine whether the register data is for DAC A, DAC B, DAC C, or DAC D. The address bits are followed by two bits that determine the mode of operation (writing to a DAC register without updating the outputs of all four DACs, writing to a DAC register and updating the outputs of all four DACs, writing to the register of all four DACs and updating their outputs, or powering down all four outputs). The final twelve bits of the shift register are the data bits. The data format is straight binary (MSB first, LSB last), with all 0's corresponding to an output of 0V and all 1's corresponding to a full-scale output of $V_{REFIN} - 1$ LSB. The contents of the serial input register are transferred to the DAC register on the sixteenth falling edge of SCLK. See Timing Diagram, [Figure 2](#).

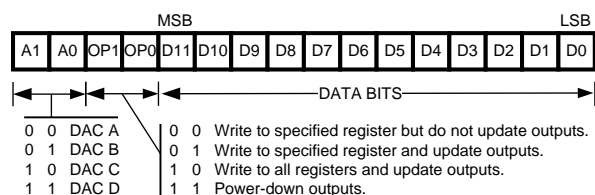

Figure 30. Input Register Contents

Normally, the $\overline{\text{SYNC}}$ line is kept low for at least 16 falling edges of SCLK and the DAC is updated on the 16th SCLK falling edge. However, if $\overline{\text{SYNC}}$ is brought high before the 16th falling edge, the data transfer to the shift register is aborted and the write sequence is invalid. Under this condition, the DAC register is not updated and there is no change in the mode of operation or in the DAC output voltages.

POWER-ON RESET

The power-on reset circuit controls the output voltages of the four DACs during power-up. Upon application of power, the DAC registers are filled with zeros and the output voltages are 0V. The outputs remain at 0V until a valid write sequence is made to the DAC.

POWER-DOWN MODES

The DAC124S085 has four power-down modes, two of which are identical. In power-down mode, the supply current drops to 20 μA at 3V and 30 μA at 5V. The DAC124S085 is set in power-down mode by setting OP1 and OP0 to 11. Since this mode powers down all four DACs, the address bits, A1 and A0, are used to select different output terminations for the DAC outputs. Setting A1 and A0 to 00 or 11 causes the outputs to be tri-stated (a high impedance state). While setting A1 and A0 to 01 or 10 causes the outputs to be terminated by 2.5 k Ω or 100 k Ω to ground respectively (see [Table 1](#)).

Table 1. Power-Down Modes

A1	A0	OP1	OP0	Operating Mode
0	0	1	1	High-Z outputs
0	1	1	1	2.5 kΩ to GND
1	0	1	1	100 kΩ to GND
1	1	1	1	High-Z outputs

The bias generator, output amplifiers, resistor strings, and other linear circuitry are all shut down in any of the power-down modes. However, the contents of the DAC registers are unaffected when in power-down. Each DAC register maintains its value prior to the DAC124S085 being powered down unless it is changed during the write sequence which instructed it to recover from power down. Minimum power consumption is achieved in the power-down mode with $\overline{\text{SYNC}}$ and D_{IN} idled low and SCLK disabled. The time to exit power-down (Wake-Up Time) is typically t_{WU} , which is stated in the A.C. and Timing Characteristics table.

APPLICATIONS INFORMATION

USING REFERENCES AS POWER SUPPLIES

While the simplicity of the DAC124S085 implies ease of use, it is important to recognize that the path from the reference input (V_{REFIN}) to the VOUTs will have essentially zero Power Supply Rejection Ratio (PSRR). Therefore, it is necessary to provide a noise-free supply voltage to V_{REFIN} . In order to utilize the full dynamic range of the DAC124S085, the supply pin (V_{A}) and V_{REFIN} can be connected together and share the same supply voltage. Since the DAC124S085 consumes very little power, a reference source may be used as the reference input and/or the supply voltage. The advantages of using a reference source over a voltage regulator are accuracy and stability. Some low noise regulators can also be used. Listed below are a few reference and power supply options for the DAC124S085.

LM4130

The LM4130, with its 0.05% accuracy over temperature, is a good choice as a reference source for the DAC124S085. The 4.096V version is useful if a 0 to 4.095V output range is desirable or acceptable. Bypassing the LM4130 VIN pin with a 0.1μF capacitor and the VOUT pin with a 2.2μF capacitor will improve stability and reduce output noise. The LM4130 comes in a space-saving 5-pin SOT23.

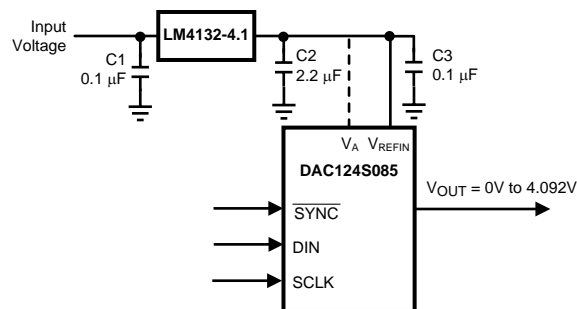
**Figure 31. The LM4130 as a power supply**

LM4050

Available with accuracy of 0.44%, the LM4050 shunt reference is also a good choice as a reference for the DAC124S085. It is available in 4.096V and 5V versions and comes in a space-saving 3-pin SOT23.

LP2980

The LP2980 is an ultra low dropout regulator with a 0.5% or 1.0% accuracy over temperature, depending upon grade. It is available in 3.0V, 3.3V and 5V versions, among others.

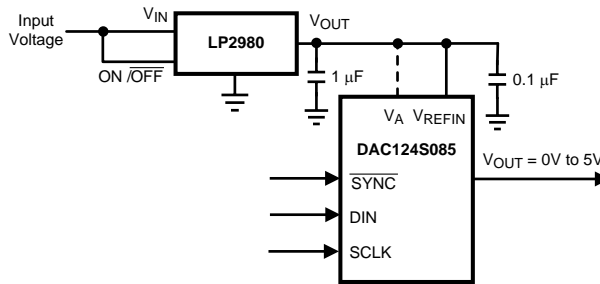

Figure 34. Using the LP2980 regulator

Like any low dropout regulator, the LP2980 requires an output capacitor for loop stability. This output capacitor must be at least 1.0µF over temperature, but values of 2.2µF or more will provide even better performance. The ESR of this capacitor should be within the range specified in the LP2980 data sheet. Surface-mount solid tantalum capacitors offer a good combination of small size and ESR. Ceramic capacitors are attractive due to their small size but generally have ESR values that are too low for use with the LP2980. Aluminum electrolytic capacitors are typically not a good choice due to their large size and have ESR values that may be too high at low temperatures.

BIPOLAR OPERATION

The DAC124S085 is designed for single supply operation and thus has a unipolar output. However, a bipolar output may be obtained with the circuit in [Figure 35](#). This circuit will provide an output voltage range of ±5 Volts. A rail-to-rail amplifier should be used if the amplifier supplies are limited to ±5V.

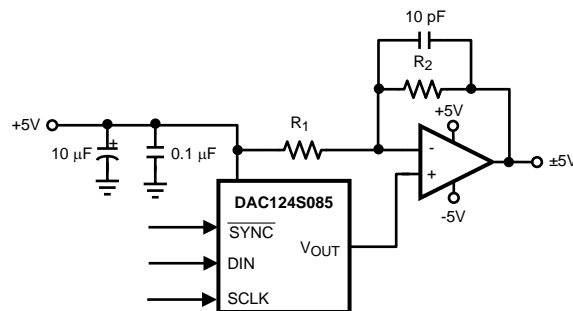

Figure 35. Bipolar Operation

The output voltage of this circuit for any code is found to be

$$V_O = (V_A \times (D / 4096) \times ((R1 + R2) / R1) - V_A \times R2 / R1)$$

where

- D is the input code in decimal form (5)

With $V_A = 5V$ and $R1 = R2$,

$$V_O = (10 \times D / 4096) - 5V$$
 (6)

A list of rail-to-rail amplifiers suitable for this application are indicated in [Table 2](#).

Table 2. Some Rail-to-Rail Amplifiers

AMP	PKGS	Typ V_{OS}	Typ I_{SUPPLY}
LMC7111	DIP-8 SOT23-5	0.9 mV	25 μ A
LM7301	SO-8 SOT23-5	0.03 mV	620 μ A
LM8261	SOT23-5	0.7 mV	1 mA

DSP/MICROPROCESSOR INTERFACING

Interfacing the DAC124S085 to microprocessors and DSPs is quite simple. The following guidelines are offered to hasten the design process.

ADSP-2101/ADSP2103 Interfacing

Figure 36 shows a serial interface between the DAC124S085 and the ADSP-2101/ADSP2103. The DSP should be set to operate in the SPORT Transmit Alternate Framing Mode. It is programmed through the SPORT control register and should be configured for Internal Clock Operation, Active Low Framing and 16-bit Word Length. Transmission is started by writing a word to the Tx register after the SPORT mode has been enabled.

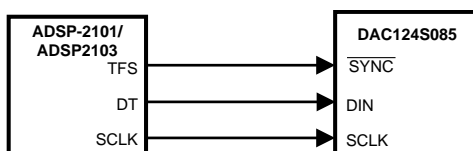

Figure 36. ADSP-2101/2103 Interface

80C51/80L51 Interface

A serial interface between the DAC124S085 and the 80C51/80L51 microcontroller is shown in Figure 37. The SYNC signal comes from a bit-programmable pin on the microcontroller. The example shown here uses port line P3.3. This line is taken low when data is transmitted to the DAC124S085. Since the 80C51/80L51 transmits 8-bit bytes, only eight falling clock edges occur in the transmit cycle. To load data into the DAC, the P3.3 line must be left low after the first eight bits are transmitted. A second write cycle is initiated to transmit the second byte of data, after which port line P3.3 is brought high. The 80C51/80L51 transmit routine must recognize that the 80C51/80L51 transmits data with the LSB first while the DAC124S085 requires data with the MSB first.

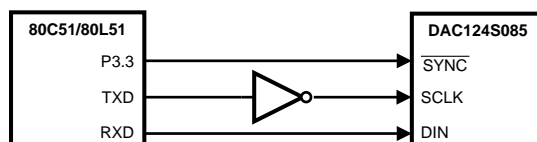

Figure 37. 80C51/80L51 Interface

68HC11 Interface

A serial interface between the DAC124S085 and the 68HC11 microcontroller is shown in Figure 38. The \overline{SYNC} line of the DAC124S085 is driven from a port line (PC7 in the figure), similar to the 80C51/80L51.

The 68HC11 should be configured with its CPOL bit as a zero and its CPHA bit as a one. This configuration causes data on the MOSI output to be valid on the falling edge of SCLK. PC7 is taken low to transmit data to the DAC. The 68HC11 transmits data in 8-bit bytes with eight falling clock edges. Data is transmitted with the MSB first. PC7 must remain low after the first eight bits are transferred. A second write cycle is initiated to transmit the second byte of data to the DAC, after which PC7 should be raised to end the write sequence.

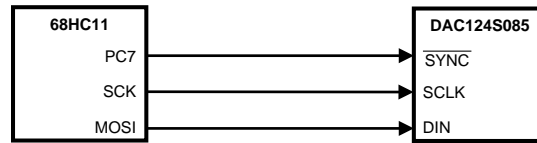

Figure 38. 68HC11 Interface

Microwire Interface

Figure 39 shows an interface between a Microwire compatible device and the DAC124S085. Data is clocked out on the rising edges of the SK signal. As a result, the SK of the Microwire device needs to be inverted before driving the SCLK of the DAC124S085.

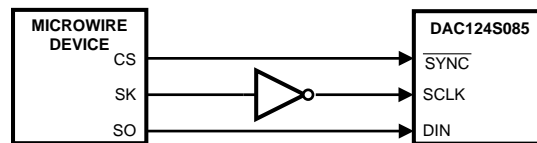

Figure 39. Microwire Interface

LAYOUT, GROUNDING, AND BYPASSING

For best accuracy and minimum noise, the printed circuit board containing the DAC124S085 should have separate analog and digital areas. The areas are defined by the locations of the analog and digital power planes. Both of these planes should be located in the same board layer. There should be a single ground plane. A single ground plane is preferred if digital return current does not flow through the analog ground area. Frequently a single ground plane design will utilize a "fencing" technique to prevent the mixing of analog and digital ground current. Separate ground planes should only be utilized when the fencing technique is inadequate. The separate ground planes must be connected in one place, preferably near the DAC124S085. Special care is required to ensure that digital signals with fast edge rates do not pass over split ground planes. They must always have a continuous return path below their traces.

The DAC124S085 power supply should be bypassed with a 10 μ F and a 0.1 μ F capacitor as close as possible to the device with the 0.1 μ F right at the device supply pin. The 10 μ F capacitor should be a tantalum type and the 0.1 μ F capacitor should be a low ESL, low ESR type. The power supply for the DAC124S085 should only be used for analog circuits.

Avoid crossover of analog and digital signals and keep the clock and data lines on the component side of the board. The clock and data lines should have controlled impedances.

REVISION HISTORY

Changes from Revision E (March 2013) to Revision F	Page
<hr/> <ul style="list-style-type: none">• Changed layout of National Data Sheet to TI format	<hr/> 20

PACKAGING INFORMATION

Orderable Device	Status (1)	Package Type	Package Drawing	Pins	Package Qty	Eco Plan (2)	Lead/Ball Finish (6)	MSL Peak Temp (3)	Op Temp (°C)	Device Marking (4/5)	Samples
DAC124S085C1MM	NRND	VSSOP	DGS	10	1000	TBD	Call TI	Call TI	-40 to 105	X66C	
DAC124S085C1MM/NOPB	ACTIVE	VSSOP	DGS	10	1000	Green (RoHS & no Sb/Br)	CU SN	Level-1-260C-UNLIM	-40 to 105	X66C	Samples
DAC124S085C1MMX/NOPB	ACTIVE	VSSOP	DGS	10	3500	Green (RoHS & no Sb/Br)	CU SN	Level-1-260C-UNLIM	-40 to 105	X66C	Samples
DAC124S085C1SD/NOPB	ACTIVE	WSON	DSC	10	1000	Green (RoHS & no Sb/Br)	CU SN	Level-1-260C-UNLIM	-40 to 105	X67C	Samples
DAC124S085C1SDX/NOPB	ACTIVE	WSON	DSC	10	4500	Green (RoHS & no Sb/Br)	CU SN	Level-1-260C-UNLIM	-40 to 105	X67C	Samples

(1) The marketing status values are defined as follows:

ACTIVE: Product device recommended for new designs.

LIFEBUY: TI has announced that the device will be discontinued, and a lifetime-buy period is in effect.

NRND: Not recommended for new designs. Device is in production to support existing customers, but TI does not recommend using this part in a new design.

PREVIEW: Device has been announced but is not in production. Samples may or may not be available.

OBSELETE: TI has discontinued the production of the device.

(2) Eco Plan - The planned eco-friendly classification: Pb-Free (RoHS), Pb-Free (RoHS Exempt), or Green (RoHS & no Sb/Br) - please check <http://www.ti.com/productcontent> for the latest availability information and additional product content details.

TBD: The Pb-Free/Green conversion plan has not been defined.

Pb-Free (RoHS): TI's terms "Lead-Free" or "Pb-Free" mean semiconductor products that are compatible with the current RoHS requirements for all 6 substances, including the requirement that lead not exceed 0.1% by weight in homogeneous materials. Where designed to be soldered at high temperatures, TI Pb-Free products are suitable for use in specified lead-free processes.

Pb-Free (RoHS Exempt): This component has a RoHS exemption for either 1) lead-based flip-chip solder bumps used between the die and package, or 2) lead-based die adhesive used between the die and leadframe. The component is otherwise considered Pb-Free (RoHS compatible) as defined above.

Green (RoHS & no Sb/Br): TI defines "Green" to mean Pb-Free (RoHS compatible), and free of Bromine (Br) and Antimony (Sb) based flame retardants (Br or Sb do not exceed 0.1% by weight in homogeneous material)

(3) MSL, Peak Temp. - The Moisture Sensitivity Level rating according to the JEDEC industry standard classifications, and peak solder temperature.

(4) There may be additional marking, which relates to the logo, the lot trace code information, or the environmental category on the device.

(5) Multiple Device Markings will be inside parentheses. Only one Device Marking contained in parentheses and separated by a "~" will appear on a device. If a line is indented then it is a continuation of the previous line and the two combined represent the entire Device Marking for that device.

(6) Lead/Ball Finish - Orderable Devices may have multiple material finish options. Finish options are separated by a vertical ruled line. Lead/Ball Finish values may wrap to two lines if the finish value exceeds the maximum column width.

Important Information and Disclaimer: The information provided on this page represents TI's knowledge and belief as of the date that it is provided. TI bases its knowledge and belief on information provided by third parties, and makes no representation or warranty as to the accuracy of such information. Efforts are underway to better integrate information from third parties. TI has taken and continues to take reasonable steps to provide representative and accurate information but may not have conducted destructive testing or chemical analysis on incoming materials and chemicals. TI and TI suppliers consider certain information to be proprietary, and thus CAS numbers and other limited information may not be available for release.

In no event shall TI's liability arising out of such information exceed the total purchase price of the TI part(s) at issue in this document sold by TI to Customer on an annual basis.

TAPE AND REEL INFORMATION

QUADRANT ASSIGNMENTS FOR PIN 1 ORIENTATION IN TAPE

*All dimensions are nominal

Device	Package Type	Package Drawing	Pins	SPQ	Reel Diameter (mm)	Reel Width W1 (mm)	A0 (mm)	B0 (mm)	K0 (mm)	P1 (mm)	W (mm)	Pin1 Quadrant
DAC124S085C1MM	VSSOP	DGS	10	1000	178.0	12.4	5.3	3.4	1.4	8.0	12.0	Q1
DAC124S085C1MM/NOPB	VSSOP	DGS	10	1000	178.0	12.4	5.3	3.4	1.4	8.0	12.0	Q1
DAC124S085C1MMX/NOPB	VSSOP	DGS	10	3500	330.0	12.4	5.3	3.4	1.4	8.0	12.0	Q1
DAC124S085C1SD/NOPB	WSON	DSC	10	1000	178.0	12.4	3.3	3.3	1.0	8.0	12.0	Q1
DAC124S085C1SDX/NOPB	WSON	DSC	10	4500	330.0	12.4	3.3	3.3	1.0	8.0	12.0	Q1

TAPE AND REEL BOX DIMENSIONS

*All dimensions are nominal

Device	Package Type	Package Drawing	Pins	SPQ	Length (mm)	Width (mm)	Height (mm)
DAC124S085C1MM	VSSOP	DGS	10	1000	210.0	185.0	35.0
DAC124S085C1MM/NOPB	VSSOP	DGS	10	1000	210.0	185.0	35.0
DAC124S085C1MMX/NOPB	VSSOP	DGS	10	3500	367.0	367.0	35.0
DAC124S085C1SD/NOPB	WSON	DSC	10	1000	210.0	185.0	35.0
DAC124S085C1SDX/NOPB	WSON	DSC	10	4500	367.0	367.0	35.0

DGS (S-PDSO-G10)

PLASTIC SMALL-OUTLINE PACKAGE

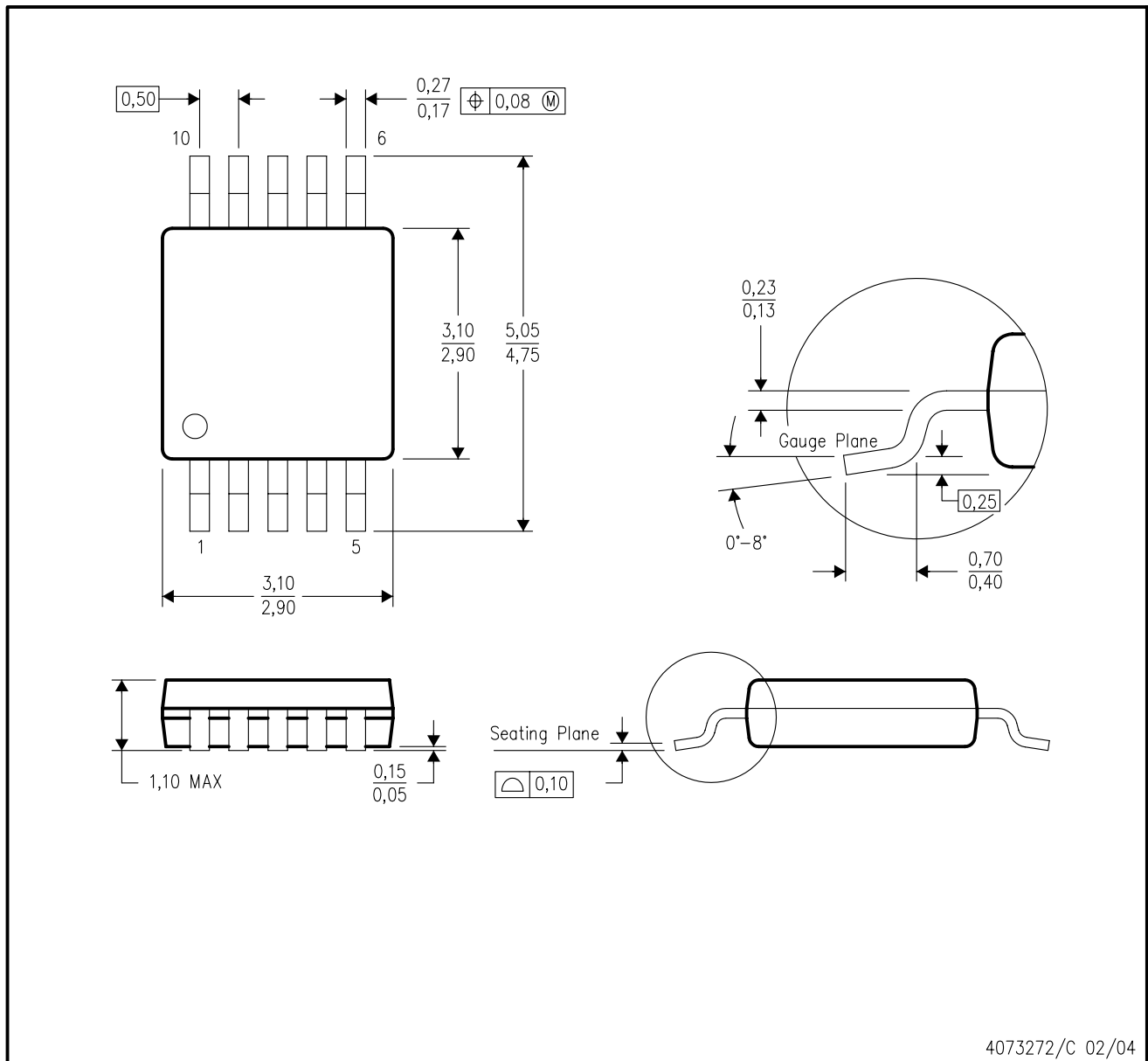

- NOTES:
- A. All linear dimensions are in millimeters.
 - B. This drawing is subject to change without notice.
 - C. Body dimensions do not include mold flash or protrusion.
 - D. Falls within JEDEC MO-187 variation BA.

DSC0010A

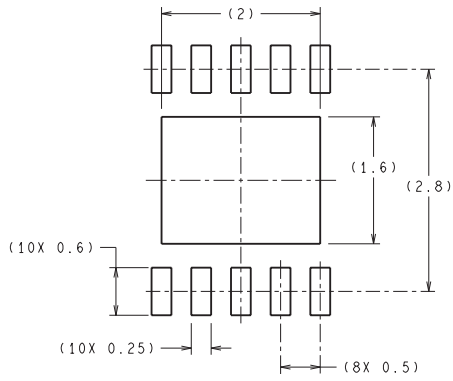

RECOMMENDED LAND PATTERN

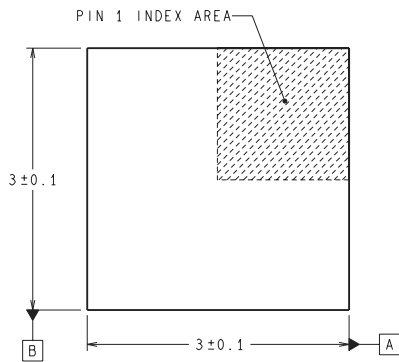

DIMENSIONS ARE IN MILLIMETERS
DIMENSIONS IN () FOR REFERENCE ONLY

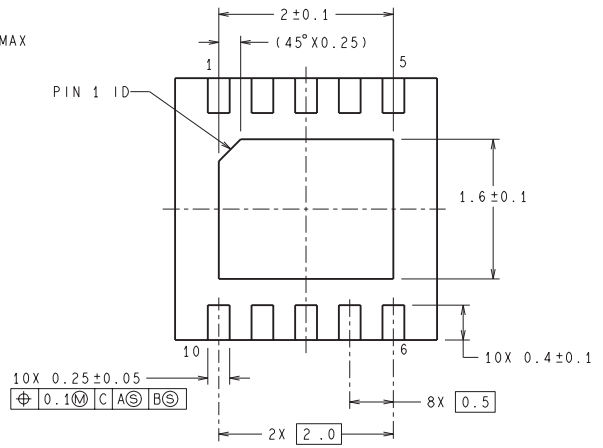
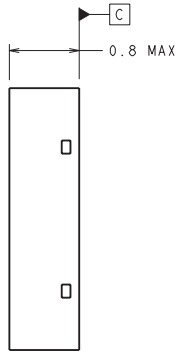
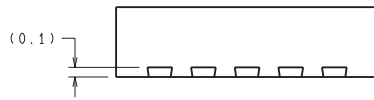

SDA10A (Rev A)

IMPORTANT NOTICE

Texas Instruments Incorporated and its subsidiaries (TI) reserve the right to make corrections, enhancements, improvements and other changes to its semiconductor products and services per JESD46, latest issue, and to discontinue any product or service per JESD48, latest issue. Buyers should obtain the latest relevant information before placing orders and should verify that such information is current and complete. All semiconductor products (also referred to herein as "components") are sold subject to TI's terms and conditions of sale supplied at the time of order acknowledgment.

TI warrants performance of its components to the specifications applicable at the time of sale, in accordance with the warranty in TI's terms and conditions of sale of semiconductor products. Testing and other quality control techniques are used to the extent TI deems necessary to support this warranty. Except where mandated by applicable law, testing of all parameters of each component is not necessarily performed.

TI assumes no liability for applications assistance or the design of Buyers' products. Buyers are responsible for their products and applications using TI components. To minimize the risks associated with Buyers' products and applications, Buyers should provide adequate design and operating safeguards.

TI does not warrant or represent that any license, either express or implied, is granted under any patent right, copyright, mask work right, or other intellectual property right relating to any combination, machine, or process in which TI components or services are used. Information published by TI regarding third-party products or services does not constitute a license to use such products or services or a warranty or endorsement thereof. Use of such information may require a license from a third party under the patents or other intellectual property of the third party, or a license from TI under the patents or other intellectual property of TI.

Reproduction of significant portions of TI information in TI data books or data sheets is permissible only if reproduction is without alteration and is accompanied by all associated warranties, conditions, limitations, and notices. TI is not responsible or liable for such altered documentation. Information of third parties may be subject to additional restrictions.

Resale of TI components or services with statements different from or beyond the parameters stated by TI for that component or service voids all express and any implied warranties for the associated TI component or service and is an unfair and deceptive business practice. TI is not responsible or liable for any such statements.

Buyer acknowledges and agrees that it is solely responsible for compliance with all legal, regulatory and safety-related requirements concerning its products, and any use of TI components in its applications, notwithstanding any applications-related information or support that may be provided by TI. Buyer represents and agrees that it has all the necessary expertise to create and implement safeguards which anticipate dangerous consequences of failures, monitor failures and their consequences, lessen the likelihood of failures that might cause harm and take appropriate remedial actions. Buyer will fully indemnify TI and its representatives against any damages arising out of the use of any TI components in safety-critical applications.

In some cases, TI components may be promoted specifically to facilitate safety-related applications. With such components, TI's goal is to help enable customers to design and create their own end-product solutions that meet applicable functional safety standards and requirements. Nonetheless, such components are subject to these terms.

No TI components are authorized for use in FDA Class III (or similar life-critical medical equipment) unless authorized officers of the parties have executed a special agreement specifically governing such use.

Only those TI components which TI has specifically designated as military grade or "enhanced plastic" are designed and intended for use in military/aerospace applications or environments. Buyer acknowledges and agrees that any military or aerospace use of TI components which have **not** been so designated is solely at the Buyer's risk, and that Buyer is solely responsible for compliance with all legal and regulatory requirements in connection with such use.

TI has specifically designated certain components as meeting ISO/TS16949 requirements, mainly for automotive use. In any case of use of non-designated products, TI will not be responsible for any failure to meet ISO/TS16949.

Products

Audio	www.ti.com/audio
Amplifiers	amplifier.ti.com
Data Converters	dataconverter.ti.com
DLP® Products	www.dlp.com
DSP	dsp.ti.com
Clocks and Timers	www.ti.com/clocks
Interface	interface.ti.com
Logic	logic.ti.com
Power Mgmt	power.ti.com
Microcontrollers	microcontroller.ti.com
RFID	www.ti-rfid.com
OMAP Applications Processors	www.ti.com/omap
Wireless Connectivity	www.ti.com/wirelessconnectivity

Applications

Automotive and Transportation	www.ti.com/automotive
Communications and Telecom	www.ti.com/communications
Computers and Peripherals	www.ti.com/computers
Consumer Electronics	www.ti.com/consumer-apps
Energy and Lighting	www.ti.com/energy
Industrial	www.ti.com/industrial
Medical	www.ti.com/medical
Security	www.ti.com/security
Space, Avionics and Defense	www.ti.com/space-avionics-defense
Video and Imaging	www.ti.com/video

TI E2E Community

e2e.ti.com