

ISO VIEW OF AX SERIES XLR CABLE CONNECTOR

One piece ground / latch spring design incorporating twin wipe contacts for a direct connection path from mating shell to ground providing enhanced connection and EMI performance

Precision socket contacts with compact solder buckets reduce termination time and material wastage during soldering.

Leading first mate last break socket contact (Pin 1)

Concentric socket contact design provides optimal contact resistance

Oversized ergonomic latch for quick and easy mating

Chuck style cable clamp c/w split opening for the widest cable acceptance range

O-ring provides vibration resistance and sealing.

Overmolded boot with flex bend relief for improved aesthetics, cable protection and boot retention.

Ergonomic sleeve with integrated expansion ring. Channel I.D capability.

Zinc Diecast Shell for robustness and wear resistance.

Concealed latching point for improved aesthetics, sealing and strength.

Ground solder tag.

Precision Machined Pin contacts with compact solder buckets reduce termination time and material wastage during soldering.

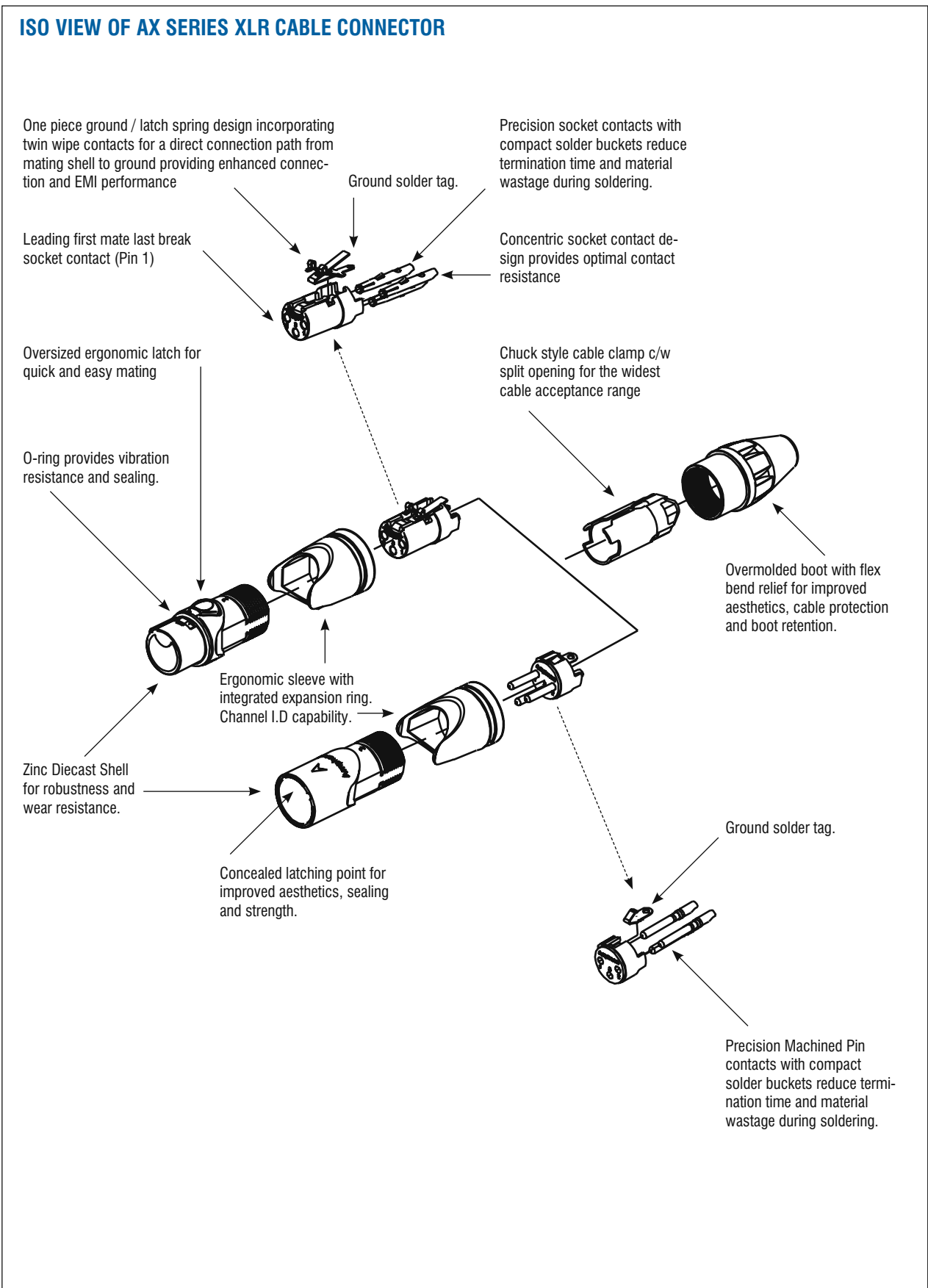



AX SERIES XLR CABLE CONNECTORS

The revolutionary AX series of XLR connectors introduce an exciting contemporary look and feel to the professional audio interconnect market. They are designed to complement modern audio architecture and truly "fit" within their environment. An impressive list of features guarantees pure sound performance in the most demanding applications providing unrivalled value.

Features

- Unique Australian designed shell and housing.
- One piece ground / latch spring design incorporating twin wipe contacts for a direct connection path from mating shell to ground providing enhanced connection and EMI performance.
- Ergonomic sleeve design for improved grip.
- Channel I.D capability with coloured sleeves.
- Oversized ergonomic latch for quick and easy mating.
- Leading first mate last break pin 1 on socket connectors.
- Chuck style cable clamp to suit 3mm - 8mm (0.118" - 0.314") cable O.D. with integrated split to allow inclusion after soldering.
- Concealed latching point for improved aesthetics, sealing and strength.
- Overmolded boot with flex bend relief for improved aesthetics, cable protection and boot retention.
- Concentric socket contact design provides optimal contact resistance
- Precision machined pin contacts as standard.
- Compact solder buckets to reduce termination time and material wastage during the soldering process.
- Zinc diecast shell housing for robustness and wear with Satin nickel or Black finish.
- Available in 3,4 and 5 contact arrangements.

Options

- Coloured I.D sleeves.
- Satin nickel or Black shell finish.
- Single or Bulk packaging.
- Gold plated contacts.

Ordering Codes

We have listed the more common ordering codes in each section. For further options please refer to the part number breakdown charts. Please contact us if you need any further assistance.

Simple steps to guide you in using this catalogue

- 1) Identify the product group listed in Contents on page 1 and go directly to that page number.
- 2) Each product group cover page then details information and options available.
- 3) Refer to the product detail pages and identify the product you require pictorially.
- 4) Read the product description column for the products standard features.
- 5) Use variations column to determine your choice.
- 6) Identify part number.
- 7) In the event the particular option you require is not listed please refer to the part number breakdown page at the end of each section.
- 8) Please contact us directly if you have any further problems.



Features:

- Unique Australian designed shell and housing.
- Ergonomic stylish sleeve design for improved grip.
- Oversized latch lever preserves your thumb.
- Leading first mate last break pin 1 on socket connectors.
- Chuck style cable clamp to suit 3mm - 8mm (0.118" - 0.314") cable O.D. with integrated split to allow inclusion after soldering.
- Overmolded cable support boot.
- New socket contact design for improved contact resistance.
- Precision machined pin contacts as standard.
- Compact solder buckets to reduce soldering time and wastage.
- Zinc diecast shell housing with Satin nickel or Matt black finish.
- Available in 3,4 and 5 contact arrangements.

Options:

- Coloured I.D sleeves.
- Clear I.D Sleeve for connector marking.
- Satin nickel or Matt black shell finish.
- Single or Bulk packaging.

Part Number Breakdown: page 6

Specifications: page 7

Assembly Instructions: PI538*

PRODUCT - FIGURE	DRAWING Dimensions in mm (inches)	DESCRIPTION	VARIATIONS	PART NUMBER
		XLR 3 pole male Machined contacts Nickel Finish	Standard Gold Plated Contacts Bulk Pack	AX3M AX3M-AU AX3M BULK
		XLR 3 pole male Machined contacts Black Finish	Standard Gold Plated Contacts Bulk Pack	AX3MB AX3MB-AU AX3MB BULK
		XLR 3 pole female Stamped contacts Nickel Finish	Standard Gold Plated Contacts Bulk Pack	AX3F AX3F-AU AX3F BULK
		XLR 3 pole female Stamped contacts Black Finish	Standard Gold Plated Contacts Bulk Pack	AX3FB AX3FB-AU AX3FB BULK
		XLR 4 pole male Machined contacts Nickel Finish	Standard Gold Plated Contacts Bulk Pack	AX4M AX4M-AU AX4M BULK

*PI538 is available for download at www.amphenolaudio.com



PRODUCT - FIGURE	DRAWING Dimensions in mm (inches)	DESCRIPTION	VARIATIONS	PART NUMBER
		XLR 4 pole male Machined contacts Black Finish	Standard	AX4MB
			Gold Plated Contacts	AX4MB-AU
			Bulk Pack	AX4MB BULK
		XLR 4 pole female Machined contacts Nickel Finish	Standard	AX4F
			Gold Plated Contacts	AX4F-AU
			Bulk Pack	AX4F BULK
		XLR 4 pole female Machined contacts Black Finish	Standard	AX4FB
			Gold Plated Contacts	AX4FB-AU
			Bulk Pack	AX4FB BULK
		XLR 5 pole male Machined contacts Nickel Finish	Standard	AX5M
			Gold Plated Contacts	AX5M-AU
			Bulk Pack	AX5M BULK
		XLR 5 pole male Machined contacts Black Finish	Standard	AX5MB
			Gold Plated Contacts	AX5MB-AU
			Bulk Pack	AX5MB BULK
		XLR 5 pole female Machined contacts Nickel Finish	Standard	AX5F
			Gold Plated Contacts	AX5F-AU
			Bulk Pack	AX5F BULK
		XLR 5 pole female Machined contacts Black Finish	Standard	AX5FB
			Gold Plated Contacts	AX5FB-AU
			Bulk Pack	AX5FB BULK



PART NUMBER BREAKDOWN

METAL SHELL TYPE - SOLDER

E. G. **AX3MB2-AU BULK**
AX (Series Prefix), **3** contacts, **M**ale, **B**lack Finish,
2 (Red Sleeve)- **AU** (Gold Plated Contacts), **BULK** Packaged.

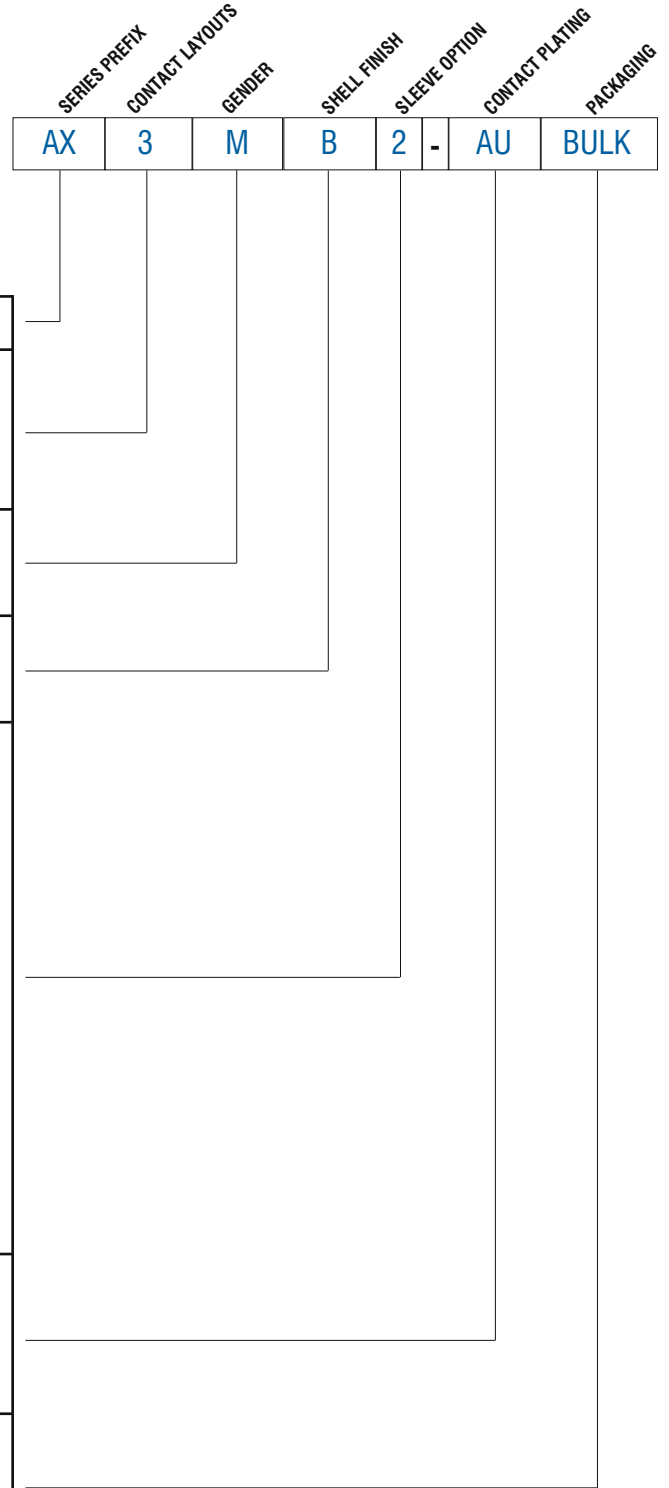

SERIES PREFIX	AX	=	Series Prefix
CONTACT LAYOUTS	3	=	3 Contacts
	4	=	4 Contacts
	5	=	5 Contacts
GENDER	F	=	Female Socket Contacts
	M	=	Male Pin Contacts
SHELL FINISH	Blank	=	Nickel Plated Finish
	B	=	Black Finish
SLEEVE OPTION	1	=	Brown
	2	=	Red
	3	=	Orange
	4	=	Yellow
	5	=	Green
	6	=	Blue
	7	=	Violet
	8	=	Grey
	9	=	White
	C	=	Clear
CONTACT PLATING	Blank	=	Standard Plating (Silver or Tin - Refer to Standard Data.)
	AU	=	Gold Plated
PACKAGING	Blank	=	Individual Bags
	BULK	=	Bulk Packed

STANDARD DATA AX SERIES CABLE CONNECTORS

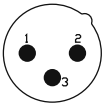
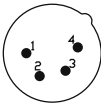
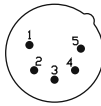

		VALUE		
GENERAL CHARACTERISTICS	Number of contacts	3	4	5
	AX Series Contact Arrangements (Front view of pin inserts)			
	Termination	SOLDER		
	Max. Wire Gauge - Stranded wire: Solder	14AWG	16AWG	18AWG
	Flammability rating of insulator plastics and housings	UL94V-0		
Environmental	Complies with EU RoHS 2 Directive 2011/65/EU			
ELECTRICAL CHARACTERISTICS	Service Voltage RMS	133V ¹⁾		
	Test Voltage AC RMS	1400V		
	Current carrying capacity: Solder	15A	10A	7.5A
	Typical Contact Resistance	≤3m Ω		
	Insulation Resistance	≥1G Ω		
CLIMATIC CHARACTERISTICS	Protection Class	IP40		
	Operating Temperature	-25 °C to +75 °C (-13°F to +167°F)		
MECHANICAL CHARACTERISTICS	Insertion and Withdrawal force	≥10N - ≤30N		
	Weight ²⁾	31g (0.068lb)	33g (0.073lb)	33g (0.073lb)
	Typical Cable retention force	22Kg to 44Kg (50lb to 100lb) - Dependent on cable material and diameter.		
	Cable O.D. range	3mm to 8mm (0.118" to 0.314")		
	Mechanical Operations	1000 mating cycles		
MATERIALS	Connector shell - Metal Shell finish	Diecast Zinc Alloy Satin nickel or Black		
	Insulators	UL94V-0 PA66, 30% Glass Filled		
	Boot / Backshell Finish	UL94V-0 Noryl N190 / Santoprene Black, other colours available - see page 80		
	Cable clamp	Noryl N190		
	Sleeve	Noryl N190		
	Male Contact Machined - Solder / Plating	Brass / Silver or Gold (Optional)		
	Female Contact Stamped - Solder / Plating	Phosphor Bronze / Tin or Gold (Optional)		

Rev 3 - 03/2013

¹⁾ Not suitable for domestic applications above 50V

²⁾ Approximate weight only, does not include packaging. Please contact us for exact weight for shipping purposes.

Amphenol

ISO VIEW OF AC3MM

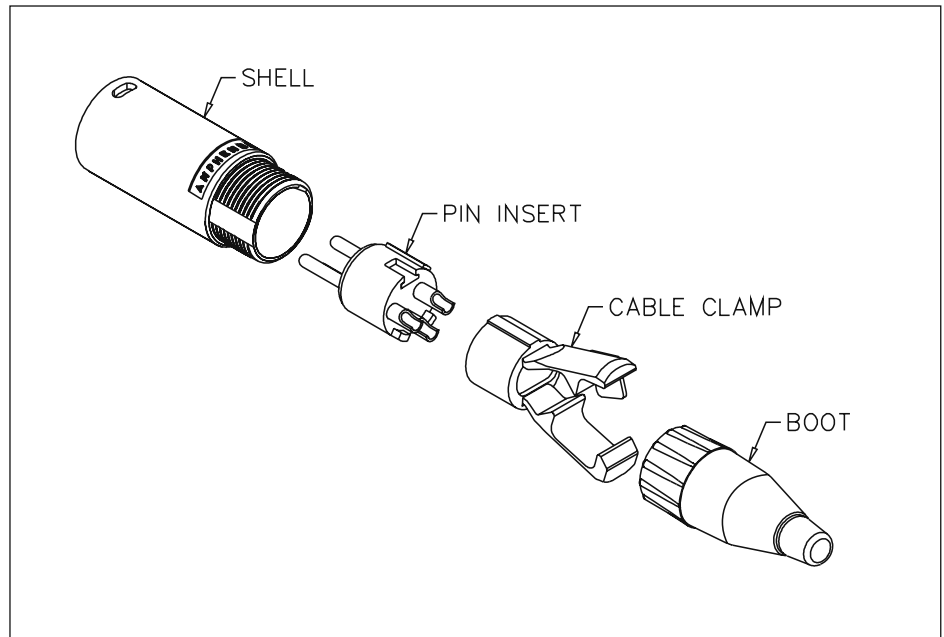

ISO VIEW OF AC3FI

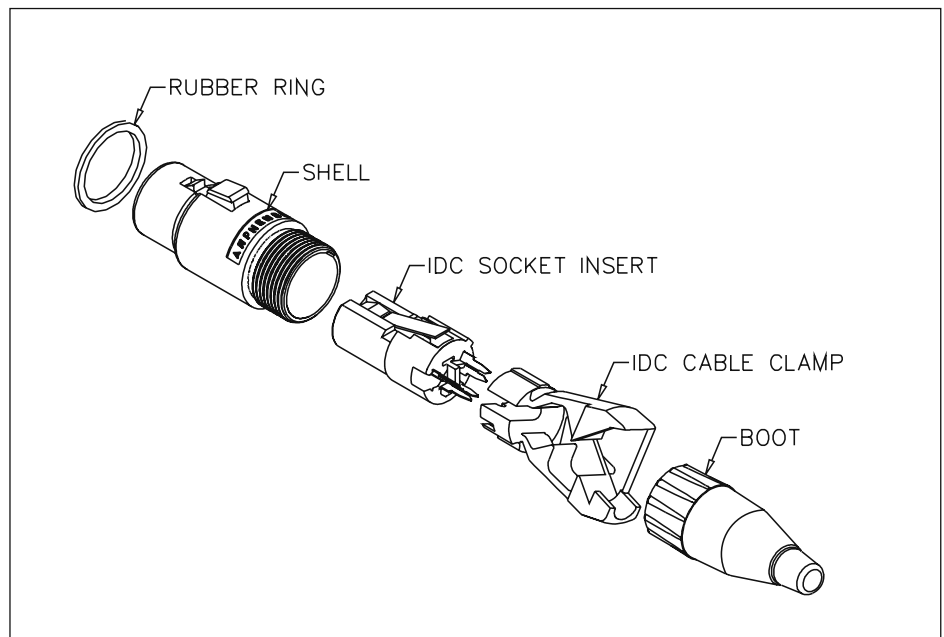

AMPHENOL AUSTRALIA WEBSITE

www.amphenolaudio.com

AMPHENOL WORLD HEADQUARTERS WEBSITE

www.amphenol.com

Amphenol



AC SERIES XLR CABLE CONNECTORS



Amphenol Australia have been manufacturing and designing innovative XLR connectors since 1955 and were the first to offer the cost saving Insulation Displacement Contact (IDC) in an XLR connector. The IDC connector is ideal for Original Equipment Manufacturers and end users alike and offers an alternative to our standard solder connector. The AC series cable connector range complies with IEC268-12 and AES 14-1992 standards. CSA File Number 68598.

Features

- AC series XLR connectors feature the unique Australian design and patented "Jaws" cable retention system for both standard Solder connectors and the Insulation Displacement Contact (IDC) connectors.
- A leading first mate last break socket contact is standard on all female connectors (Pin 1).
- The "Jaws" cable retention system provides up to 44kg (100lb) of strain.
- Solderless IDC technology offers savings of up to 60% in termination time.
- The AC series connector can be quickly and easily assembled without screws – by hand or portable termination tool. (Part number T2860)
- Available in 3, 4, 5, 6A and 7 contact arrangements.
- Compatible with all other XLR brands.

Options

- Solder Bucket termination
- Insulation Displacement Contact (IDC)
- Thermoplastic shell
- Zinc Diecast shell - Satin Nickel Finish
- Zinc Diecast shell - Black Polyester Finish
- Gold, Silver or Tin Plated contacts
- Bulk Style Packaging
- Single Bag packs
- Precision machined contacts
- Cost effective stamped contacts on 3 pole

Options (Cont'd)

- Standard Jaws cable clamp, Cable O.D 3mm to 6.5mm (0.118" to 0.255")
- Large Jaws cable clamp, Cable O.D 6.5mm to 8mm (0.255" to 0.314")
- IDC Jaws cable clamp, Max. Cable O.D 5.85mm (0.23")
- Metal Boots / Backshells
- Coloured Boots / Backshells
- Coloured Identification rings
- Termination / Assembly tooling

Jaws Cable Clamp Options



Standard Jaws cable clamp (Black), Cable O.D 3mm to 6.5mm (0.118" to 0.255")



Large Jaws cable clamp (Purple), Cable O.D 6.5mm to 8mm (0.255" to 0.314")

Ordering Codes

We have listed the more common ordering codes in each section. For further options please refer to the part number breakdown charts. Please contact us if you need any further assistance.

Simple steps to guide you in using this catalogue

- 1) Identify the product group listed in Contents on page 1 and go directly to that page number.
- 2) Each product group cover page then details information and options available.
- 3) Refer to the product detail pages and identify the product you require pictorially.
- 4) Read the product description column for the products standard features.
- 5) Use variations column to determine your choice.
- 6) Identify part number.
- 7) In the event the particular option you require is not listed please refer to the part number breakdown page at the end of each section.
- 8) Please contact us directly if you have any further problems.

Amphenol











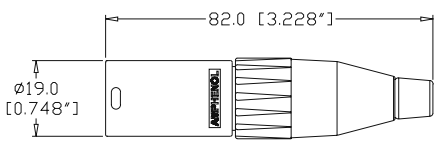

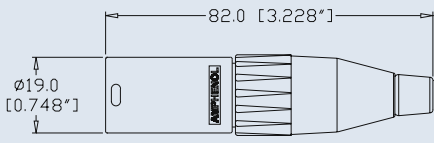
Features:

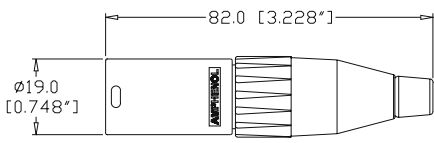
- Zinc Diecast Shell.
- Solder Bucket connections.
- "Jaws" Cable Retention System.
- Contact layouts in 3, 4, 5, 6A and 7.
- Precision machined or Stamped contacts.
- Leading first mate last break socket contact.
- Quick and easy assembly without screws – by hand or portable termination tool. (Part number T2860.)

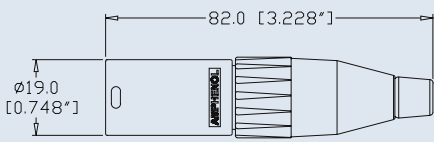

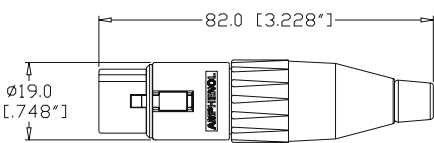

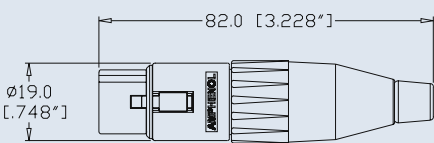





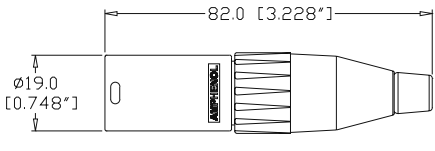

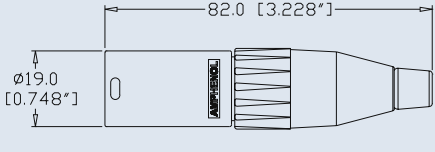

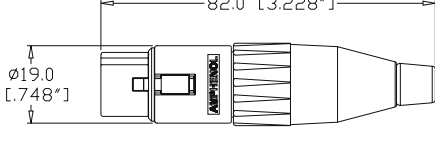
Options: Stamped Contacts (3 contact only), Gold plated contacts, Large or Small Jaws Cable Clamp, Black Finish Shell, Bulk Pack, Coloured Boots / Backshells

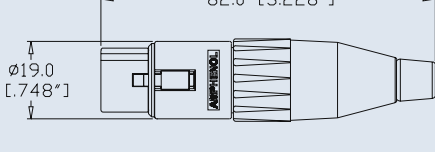
Part Number Breakdown: [page 13](#)

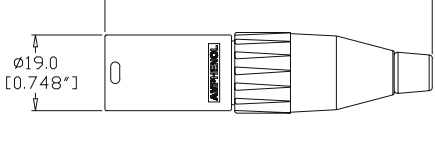
Specifications: [page 20](#)

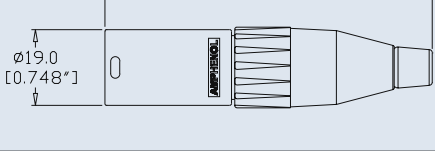

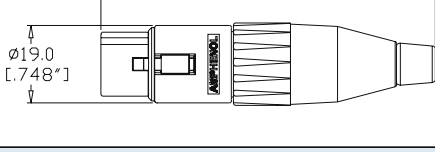

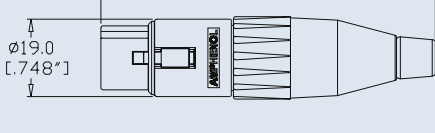



PRODUCT - FIGURE	DRAWING	DESCRIPTION	VARIATIONS	PART NUMBER
		XLR 3 pole male, Machined contacts, Nickel Finish, Jaws cable clamp	Standard Gold Plated Contacts Large Cable Clamp Bulk Pack	AC3MM AC3MM-AU AC3MMJ AC3MM BULK
		XLR 3 pole male, Machined contacts, Black Finish, Jaws cable clamp	Standard Gold Plated Contacts Large Cable Clamp Bulk Pack	AC3MMB AC3MMB-AU AC3MMBJ AC3MMB BULK
		XLR 3 pole male, Stamped contacts, Nickel Finish, Jaws cable clamp	Standard Gold Plated Contacts Large Cable Clamp Bulk Pack	AC3M AC3M-AU AC3MJ AC3M BULK
		XLR 3 pole male, Stamped contacts, Black Finish, Jaws cable clamp	Standard Gold Plated Contacts Large Cable Clamp Bulk Pack	AC3MB AC3MB-AU AC3MBJ AC3MB BULK
		XLR 3 pole female, Stamped contacts, Nickel Finish, Jaws cable clamp	Standard Gold Plated Contacts Large Cable Clamp Bulk Pack	AC3F AC3F-AU AC3FJ AC3F BULK
		XLR 3 pole female, Stamped contacts, Black Finish, Jaws cable clamp	Standard Gold Plated Contacts Large Cable Clamp Bulk Pack	AC3FB AC3FB-AU AC3FBJ AC3FB BULK

Amphenol

PRODUCT - FIGURE	DRAWING Dimensions in mm (inches)	DESCRIPTION	VARIATIONS	PART NUMBER
		XLR 4 pole male, Machined contacts, Nickel Finish, Jaws cable clamp	Standard	AC4M
			Gold Plated Contacts	AC4M-AU
			Large Cable Clamp	AC4MJ
			Bulk Pack	AC4M BULK
		XLR 4 pole male, Machined contacts, Black Finish, Jaws cable clamp	Standard	AC4MB
			Gold Plated Contacts	AC4MB-AU
			Large Cable Clamp	AC4MBJ
			Bulk Pack	AC4MB BULK
		XLR 4 pole female, Machined contacts, Nickel Finish, Jaws cable clamp	Standard	AC4F
			Gold Plated Contacts	AC4F-AU
			Large Cable Clamp	AC4FJ
			Bulk Pack	AC4F BULK
		XLR 4 pole female, Machined contacts, Black Finish, Jaws cable clamp	Standard	AC4FB
			Gold Plated Contacts	AC4FB-AU
			Large Cable Clamp	AC4FBJ
			Bulk Pack	AC4FB BULK
		XLR 5 pole male, Machined contacts, Nickel Finish, Jaws cable clamp	Standard	AC5M
			Gold Plated Contacts	AC5M-AU
			Large Cable Clamp	AC5MJ
			Bulk Pack	AC5M BULK
		XLR 5 pole male, Machined contacts, Black Finish, Jaws cable clamp	Standard	AC5MB
			Gold Plated Contacts	AC5MB-AU
			Large Cable Clamp	AC5MBJ
			Bulk Pack	AC5MB BULK
		XLR 5 pole female, Machined contacts, Nickel Finish, Jaws cable clamp	Standard	AC5F
			Gold Plated Contacts	AC5F-AU
			Large Cable Clamp	AC5FJ
			Bulk Pack	AC5F BULK
		XLR 5 pole female, Machined contacts, Black Finish, Jaws cable clamp	Standard	AC5FB
			Gold Plated Contacts	AC5FB-AU
			Large Cable Clamp	AC5FBJ
			Bulk Pack	AC5FB BULK



Amphenol

PRODUCT - FIGURE	DRAWING Dimensions in mm (inches)	DESCRIPTION	VARIATIONS	PART NUMBER
		XLR 6A pole male, Machined contacts, Nickel Finish, Jaws cable clamp	Standard	AC6AM
			Gold Plated Contacts	AC6AM-AU
			Large Cable Clamp	AC6AMJ
			Bulk Pack	AC6AM BULK
		XLR 6A pole male, Machined contacts, Black Finish, Jaws cable clamp	Standard	AC6AMB
			Gold Plated Contacts	AC6AMB-AU
			Large Cable Clamp	AC6AMBJ
			Bulk Pack	AC6AMB BULK
		XLR 6A pole female, Machined contacts, Nickel Finish, Jaws cable clamp	Standard	AC6AF
			Gold Plated Contacts	AC6AF-AU
			Large Cable Clamp	AC6AFJ
			Bulk Pack	AC6AF BULK
		XLR 6A pole female, Machined contacts, Black Finish, Jaws cable clamp	Standard	AC6AFB
			Gold Plated Contacts	AC6AFB-AU
			Large Cable Clamp	AC6AFBJ
			Bulk Pack	AC6AFB BULK
		XLR 7 pole male, Gold plated Machined contacts, Nickel Finish, Jaws cable clamp	Standard	AC7M
			Large Cable Clamp	AC7MJ
			Bulk Pack	AC7M BULK
		XLR 7 pole male, Gold plated Machined contacts, Black Finish, Jaws cable clamp	Standard	AC7MB
			Large Cable Clamp	AC7MBJ
			Bulk Pack	AC7MB BULK
		XLR 7 pole female, Gold plated Machined contacts, Nickel Finish, Jaws cable clamp	Standard	AC7F
			Large Cable Clamp	AC7FJ
			Bulk Pack	AC7F BULK
		XLR 7 pole female, Gold plated Machined contacts, Black Finish, Jaws cable clamp	Standard	AC7FB
			Large Cable Clamp	AC7FBJ
			Bulk Pack	AC7FB BULK

Amphenol

PART NUMBER BREAKDOWN

METAL SHELL TYPE - SOLDER



E. G. **AC3MMBJ-AU BULK**
AC (Series Prefix), **3** contacts, **Male**, **M** Machined Contacts, **Black** Polyester Finish,
J (Large Jaws), - **AU** (Gold Plated Contacts), **Bulk** Packaged.

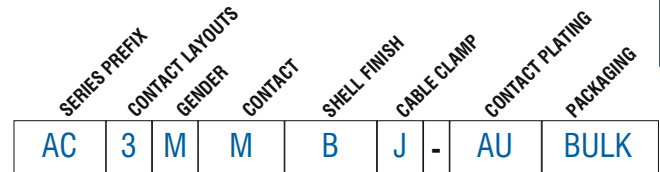

SERIES PREFIX	AC	=	Series Prefix
CONTACT LAYOUTS	3	=	3 Contacts
	4	=	4 Contacts
	5	=	5 Contacts
	6A	=	6 Contacts
	7	=	7 Contacts
GENDER	F	=	Female Socket Contacts
	M	=	Male Pin Contacts
CONTACT ¹	Blank	=	Stamped Contacts
	M	=	Machined Contacts
	G	=	Stamped Contacts, Ground Tag
	MG	=	Machined Contacts, Ground Tag (Applicable 3 male pin contacts, option M and MG only)
SHELL FINISH ²	Blank	=	Nickel Plated Finish
	B	=	Black Polyester Finish
CABLE CLAMP	Blank	=	Standard Jaws 3 mm - 6.5 mm cable O.D. (0.118" to 0.255")
	J	=	Large Jaws 6.5mm - 8mm cable O.D. (0.255" to 0.314")
CONTACT PLATING ³	Blank	=	Standard Plating (Silver or Tin - Refer to Standard Data.)
	AU	=	Gold Plated
PACKAGING	Blank	=	Individual Bags
	BULK	=	Bulk Packed

Note:

¹ 4 - 7 contact connectors have machined contacts and grounding as standard.

² Ground contacts are not supplied with the black polyester finish shell option.

³ 7 Contact is gold plated as standard.

⁴ All AC Series Connectors are available with optional colour coded boot / backshell.
 Refer to page 137 and simply add colour to end of part number. Example: AC3MM - RED





Features:

- Thermoplastic Shell.
- Solder Bucket Connections.
- “Jaws” Cable Retention System.
- Stamped or Machined Contacts.
- Leading first mate last break socket contact.
- Quick and easy assembly without screws – by hand or portable termination tool. (Part number T2860.)

Options: Gold Plated Contacts, Stamped Contacts (3 Contact only), Bulk Pack, Coloured Boots / Backshells
3, 4, 5, 6A and 7 Contacts.

Specifications: page 20

PRODUCT - FIGURE	DRAWING	DESCRIPTION	VARIATIONS	PART NUMBER
		XLR 3 pole male, Machined contacts, Thermoplastic shell, Jaws cable clamp	Standard	AC3MMCP
			Gold Plated Contacts	AC3MMCP-AU
			Large Cable Clamp	AC3MMCPJ
			Bulk Pack	AC3MMCP BULK
		XLR 3 pole male, Stamped contacts, Thermoplastic shell, Jaws cable clamp	Standard	AC3MCP
			Gold Plated Contacts	AC3MCP-AU
			Large Cable Clamp	AC3MCPJ
			Bulk Pack	AC3MCP BULK
		XLR 3 pole female, Stamped contacts, Thermoplastic shell, Jaws cable clamp	Standard	AC3FCP
			Gold Plated Contacts	AC3FCP-AU
			Large Cable Clamp	AC3FCPJ
			Bulk Pack	AC3FCP BULK

Note: Thermoplastic shell connectors are also available in 4 - 7 contact arrangements, please contact us for ordering code.

ISO VIEW OF AC3MM

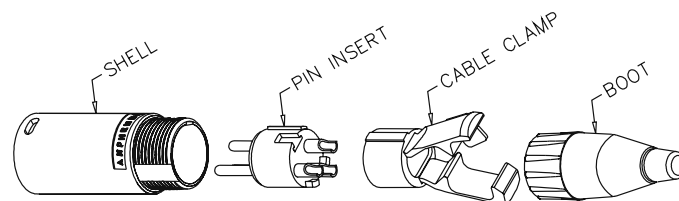

METAL SHELL TYPE RIGHT ANGLE - SOLDER



Features:

- XLR 90° right angle
- Metal or Thermoplastic connector shell
- Thermoplastic 90° right angle backshell
- Solder bucket connections
- "Jaws"™ Cable Retention System
- Contact Layouts in 3, 4, 5, 6A and 7
- Precision machined pin contacts
- Leading first mate last break socket contact

Specifications: [page 20](#)

Assembly Tooling: [page 137](#)

NOTE* Connector assembly requires the use of assembly tool T2880. Please refer to assembly instruction PI540* for details. The connector is non-servicable once assembled.



PRODUCT - FIGURE	DRAWING	DESCRIPTION	VARIATIONS	PART NUMBER
		XLR 90° right angle female, Metal shell, Nickel Finish, Jaws cable clamp	3 pole	AC3FR
			4 pole	AC4FR
			5 pole	AC5FR
			6A pole	AC6AFR
			7 pole	AC7FR
		XLR 90° right angle male, Metal shell, Nickel Finish, Jaws cable clamp	3 pole	AC3MMR
			4 pole	AC4MR
			5 pole	AC5MR
			6A pole	AC6AMR
			7 pole	AC7MR

*PI540 is available for download at www.amphenolaudio.com

Amphenol

METAL SHELL TYPE - IDC (SOLDERLESS)



The Insulation Displacement Contact (IDC) connector is ideal for Original Equipment Manufacturers and end users alike and offers an alternative to our standard solder connector. Connectors can be quickly and easily assembled without screws or a soldering iron – by hand or portable termination tool. (Part number T2860.)

Labour savings of up to 60% in termination time can be achieved.

Recommended Cable Dimensions: page 21

Features:

- Zinc Diecast Shell
- Available in 3 Contact only.
- Insulation Displacement Contacts (IDC - Solderless).
- “Jaws” Cable Retention System.
- Leading first mate last break socket contact.

Options: Gold plated contacts, Black Finish Shell, Bulk Pack, Coloured Boots / Backshells.

Specifications: page 20

Assembly Instructions: page 19

PRODUCT - FIGURE	DRAWING	DESCRIPTION	VARIATIONS	PART NUMBER
		XLR 3 pole male, IDC contacts, Nickel Finish, IDC Jaws cable clamp	Standard	AC3MI
			Gold Plated Contacts	AC3MI-AU
			Bulk Pack	AC3MI BULK
		XLR 3 pole male, IDC contacts, Black Finish, IDC Jaws cable clamp	Standard	AC3MIB
			Gold Plated Contacts	AC3MIB-AU
			Bulk Pack	AC3MIB BULK
		XLR 3 pole female, IDC contacts, Nickel Finish, IDC Jaws cable clamp	Standard	AC3FI
			Gold Plated Contacts	AC3FI-AU
			Bulk Pack	AC3FI BULK
		XLR 3 pole female, IDC contacts, Black Finish, IDC Jaws cable clamp	Standard	AC3FIB
			Gold Plated Contacts	AC3FIB-AU
			Bulk Pack	AC3FIB BULK

Note: Amphenol can not guarantee the termination performance unless the recommended cable dimensions listed on page 21 are followed.

ISO VIEW OF AC3FI

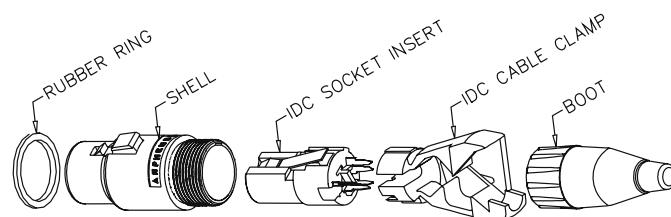

Amphenol

PART NUMBER BREAKDOWN

METAL SHELL TYPE - IDC



E. G . **AC3MIB-AU BULK**
AC (Series Prefix), **3** contacts, **M**ale, IDC Contacts, **B**lack Polyester Finish,
 - **AU** (Gold Plated Contacts), **BULK** Packaged.

SERIES PREFIX	AC	=	Series Prefix
CONTACT LAYOUT	3	=	3 Contact only
GENDER	F	=	Female Socket Contacts
	M	=	Male Pin Contacts
TERMINATION METHOD	I	=	IDC Contacts
SHELL FINISH	Blank	=	Nickel Plated Finish
	B	=	Black Polyester Finish
CONTACT PLATING	Blank	=	Standard Plating (Silver or Tin - Refer to Standard Data.)
	AU	=	Gold Plated
PACKAGING	Blank	=	Individual Bags
	BULK	=	Bulk Packed

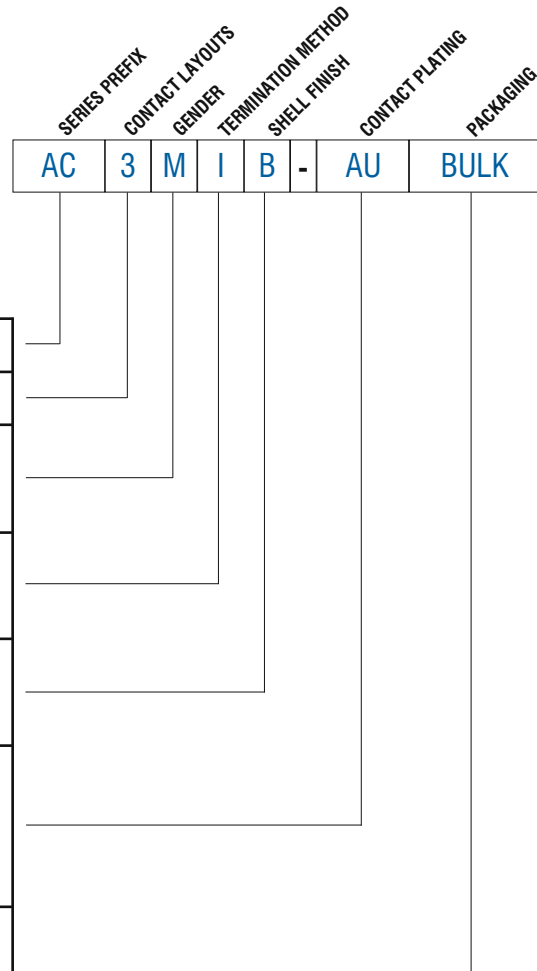

Note: All AC Series Connectors are available with optional colour coded boot / backshell. Refer to page 80 and simply add colour to end of part number. Example: AC3MI - RED

THERMOPLASTIC SHELL TYPE - IDC (SOLDERLESS)





The Insulation Displacement Contact (IDC) connector is ideal for Original Equipment Manufacturers and end users alike and offers an alternative to our standard solder connector. Connectors can be quickly and easily assembled without screws or a soldering iron – by hand or portable termination tool. Labour savings of up to 60% in termination time can be achieved.

Recommended Cable Dimensions: page 21

Features:

- Thermoplastic Shell
- Insulation Displacement Contacts (IDC - Solderless).
- “Jaws” Cable Retention System.
- Leading first mate last break socket contact.
- Quick and easy assembly without screws – by hand or portable termination tool. (Part number T2860.)

Options: Gold plated contacts, Bulk Pack, Coloured Boots / Backshells
Specifications: page 20

PRODUCT - FIGURE	DRAWING	DESCRIPTION	VARIATIONS	PART NUMBER
		XLR 3 pole male, IDC contacts, Thermoplastic shell, IDC Jaws cable clamp	Standard	AC3MCPI
			Gold Plated Contacts	AC3MCPI-AU
			Bulk Pack	AC3MCPI BULK
		XLR 3 pole female, IDC contacts, Thermoplastic shell, IDC Jaws cable clamp	Standard	AC3FCPI
			Gold Plated Contacts	AC3FCPI-AU
			Bulk Pack	AC3FCPI BULK

Note: Amphenol can not guarantee the termination performance unless the recommended cable dimensions listed on page 21 are followed.

PART NUMBER BREAKDOWN

IDC THERMOPLASTIC SHELL TYPE

E. G. **AC3MCPI-AU BULK**
 AC (Series Prefix), 3 contacts, Male, CP (Thermoplastic Shell), IDC Contacts, - AU (Gold Plated Contacts), Bulk Packaged.

SERIES PREFIX	AC	=	Series Prefix
CONTACT LAYOUT	3	=	3 Contacts only
GENDER	F	=	Female Socket Contacts
	M	=	Male Pin Contacts
SHELL MATERIAL	CP	=	Thermoplastic Shell
TERMINATION METHOD	I	=	IDC Contacts
CONTACT PLATING	Blank	=	Standard Plating (Silver or Tin - Refer to Standard Data.)
	AU	=	Gold Plated
PACKAGING	Blank	=	Individual Bags
	BULK	=	Bulk Packed

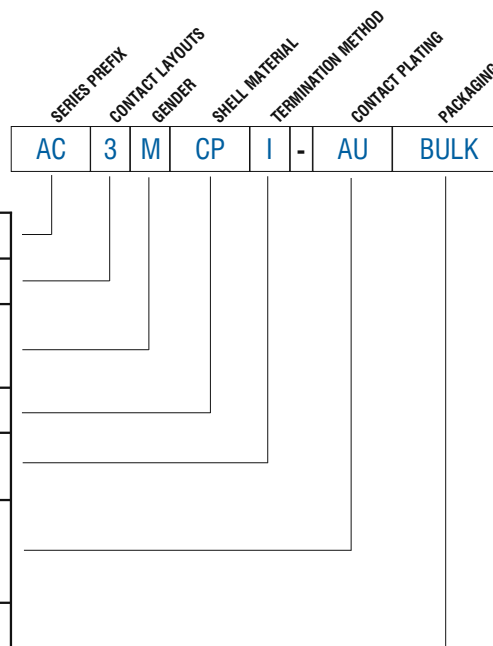

Note: All AC Series Connectors are available with optional colour coded boot / backshell. Refer to page 80 and simply add colour to end of part number. Example: AC3MCPI - RED

AC IDC SERIES CABLE ASSEMBLY INSTRUCTIONS

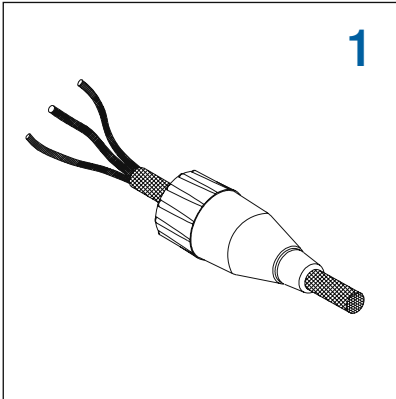

1

Push the cable through the boot assembly and strip the cable back 35 to 40 mm. Twist the shield wire.

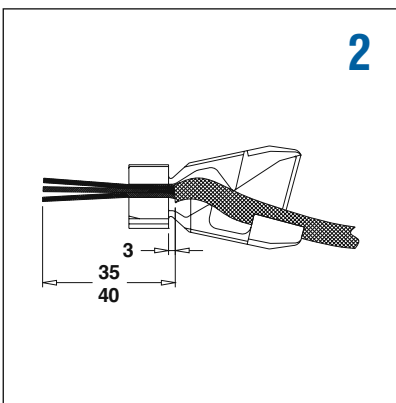

2

Fit the cable into the 'Jaws' cable clamp ensuring that the cable is pushed up to the neck of the clamp within 3mm.

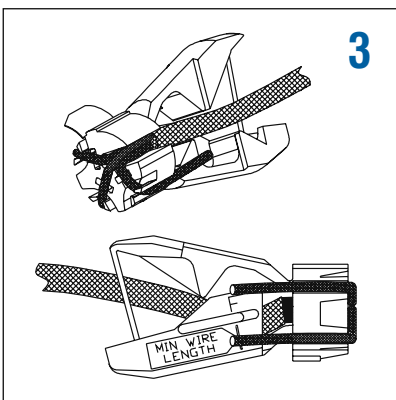

3

Pull back the conductors into their individual wire guidetracks. Note: Two spring fingers in the clamp will hold the conductors in position during subsequent operations. The ends of the two insulated wires must be on or past the minimum wire length mark.

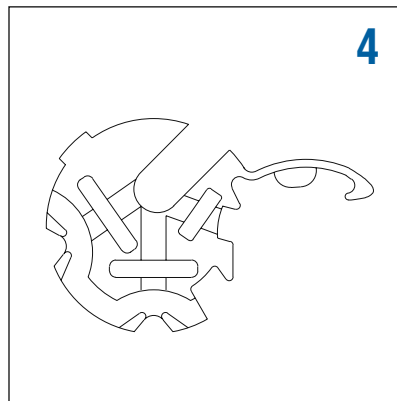

4

For ground protection the twisted shield wire is clipped in place with the ground protect flap.

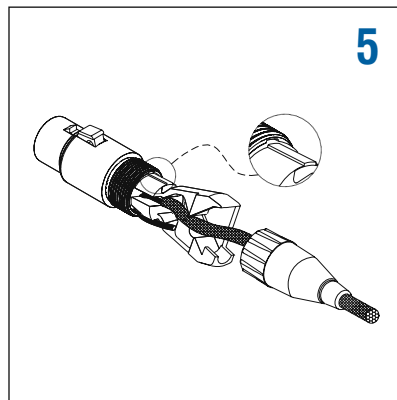

5

Trim back the shield wire, so there are no wires coming out of the flap and fit the 'Jaws' cable clamp into the shell assembly, ensuring the keyways are aligned.

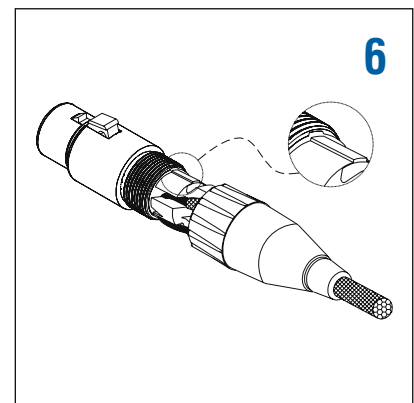

6

Close the cable clamp slightly and push the boot over the clamp ensuring the wires fit inside the boot.

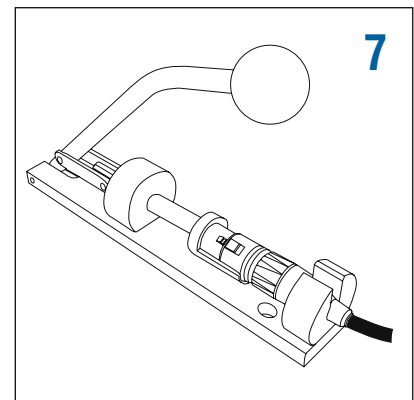

7

Final assembly can be achieved either by manually screwing the boot on, or by using an Amphenol Australia T2860 termination tool.

Amphenol

STANDARD DATA AC CABLE CONNECTORS

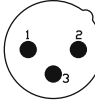
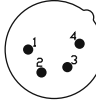
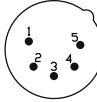
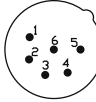
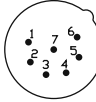
		VALUE				
GENERAL CHARACTERISTICS	Number of contacts	3	4	5	6A	7
	AC Series Contact Arrangements (Front view of pin inserts)					
	Termination	IDC / SOLDER	SOLDER	SOLDER	SOLDER	SOLDER
	Max. Wire Gauge - Stranded wire:					
	IDC	24AWG	N/A	N/A	N/A	N/A
	Solder	14AWG	16AWG	18AWG	18AWG	20AWG
	Flammability rating of insulator plastics and housings	UL94V-0				
Environmental	Complies with EU RoHS 2 Directive 2011/65/EU					
ELECTRICAL CHARACTERISTICS	Service Voltage RMS	133V ¹⁾				
	Test Voltage AC RMS	1400V				
	Current carrying capacity:					
	IDC	1A	N/A	N/A	N/A	N/A
	Solder	15A	10A	7.5A	7.5A	5A
	Typical Contact Resistance	≤3mΩ				
Insulation Resistance	≥1GΩ					
CLIMATIC CHARACTERISTICS	Protection Class	IP40				
	Operating Temperature	-25°C to +75°C (-13°F to +167°F)				
MECHANICAL CHARACTERISTICS	Insertion and Withdrawal force	≥10N - ≤30N				
	Weight - Metal ²⁾	36g (0.080lb)	37g (0.081lb)	38g (0.083lb)	38g (0.083lb)	38g (0.083lb)
	Weight - Thermoplastic ²⁾	18g (0.039lb)	19g (0.041lb)	20g (0.044lb)	20g (0.044lb)	20g (0.044lb)
	Typical Cable retention force	22Kg to 44Kg (50lb to 100lb) - Dependent on cable material and diameter.				
	Cable O.D. range - JAWS clamp					
	IDC	Max. Cable O.D. 5.85mm (0.23")				
	Standard solder	3mm to 6.5mm (0.118" to 0.255")				
	Large Solder	6.5mm to 8mm (0.255" to 0.314")				
Mechanical Operations	1000 mating cycles					

Rev 5 - 03/2013

¹⁾ Not suitable for domestic applications above 50V

²⁾ Approximate weight only, does not include packaging. Please contact us for exact weight for shipping purposes.

Amphenol

STANDARD DATA AC CABLE CONNECTORS

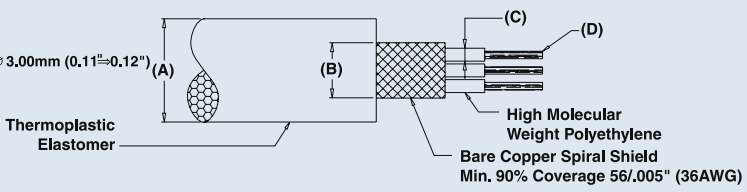
		DETAILS
MATERIALS	Connector shell - Metal	Diecast Zinc Alloy
	Shell finish	Satin nickel or Black polyester
	Connector shell - Thermoplastic	Thermoplastic, UL94V-0 Modified PPE Resin
	Shell finish	Black
	Insulators	UL94V-0 PBT Resin or Modified PPE Resin
	Boot / Backshell	UL94V-0 Modified PPE Resin or Machined Brass
	Finish	Black, other colours available - see page 80
	Cable clamp	
	IDC Socket JAWS	UL94V-0 Modified PPO Resin (Pink)
	IDC Pin JAWS	UL94V-0 Modified PPO Resin (Blue)
	Standard Solder JAWS	UL94V-0 Modified PPO Resin (Black)
	Large Solder JAWS	UL94V-0 Modified PPO Resin (Purple)
	Cable Bushing	Santoprene
	Male Contact	Thermoplastic Polyurethane
	Stamped - IDC / Plating	Phosphor Bronze / Silver or Gold (Optional)
	Stamped - Solder / Plating	Phosphor Bronze / Silver or Gold (Optional)
Machined - Solder / Plating	Brass / Silver or Gold (Optional)	
Female Contact		
Stamped - IDC / Plating	Phosphor Bronze / Tin or Gold (Optional)	
Stamped - Solder / Plating	Phosphor Bronze / Tin or Gold (Optional)	
Machined - Solder / Plating	Brass / Silver or Gold (Optional)	
IDC RECOMMENDED CABLE DIMENSIONS	 <p> A - Cable O.D.: Max. \varnothing 5.85mm (0.23"). B - Bare Copper Spiral Shield OD \varnothing 2.75 \Rightarrow \varnothing 3.00mm (0.11" \Rightarrow 0.12") C - OD \varnothing 1.30 \Rightarrow \varnothing 1.50mm (0.05" \Rightarrow 0.06") D - 16/.005" (24 AWG stranded wire) </p>	



Rev 4 - 03/2013