

A16□-P

Pushbutton Switch (Detachable) (Lighted/Non-Lighted) (Cylindrical 16-dia.)

CSM_A16_-P_DS_J_1_3

PCB Terminal Models

- Lever made of high heat resistant resin allowing automatic soldering.
- Easy Panel and PCB mounting.
- Lever for easily mounting and removing the Socket Unit.
- The hold status can easily be checked from the rear of the PCB.
- Short profile width of the separable type reduced to 28.3 mm.
Panel width can also be reduced.

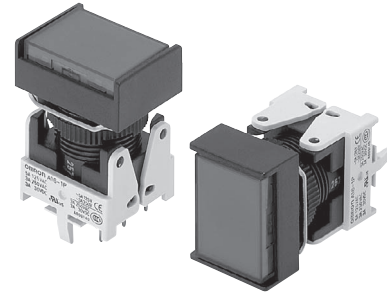

A
1
6
□
P

RoHS Compliant

Refer to Safety Precautions for All Pushbutton Switches and Safety Precautions on page 24.

List of Models

■ **Ordering as a Set**..... The model numbers used to order sets of Units are given in the following tables. One set comprises the Pushbutton, Lamp (lighted models only), Case, and Switch.

Models with PCB Terminals IP40

Output	Lighting	Operating voltage	Item	Momentary operation (Self-resetting) *1	Pushbutton color symbol	Minimum packing unit
SPDT	LED	5 VDC		A16L-Δ□M-5D-1P	R: red Y: yellow PY: pure yellow G: green A: blue W: white B: black *2	5 pcs
		12 VAC/VDC		A16L-Δ□M-12D-1P		
		24 VAC/VDC		A16L-Δ□M-24D-1P		
	Non-lighted			A16-Δ□M-1P		
DPDT	LED	5 VDC		A16L-Δ□M-5D-2P		
		12 VAC/VDC		A16L-Δ□M-12D-2P		
		24 VAC/VDC		A16L-Δ□M-24D-2P		
	Non-lighted			A16-Δ□M-2P		

Note: Contact your OMRON representative about Selector Switches and Key Selector Switches.

*1. Enter the desired shape for the Pushbutton in Δ: J (rectangular), A (square), or T (round). Enter the desired color symbol for the Pushbutton in the □.

*2. Black ("B") Pushbuttons are only available for non-lighted models.

Models with PCB Terminals IP65

Output	Lighting	Operating voltage	Item	Momentary operation (Self-resetting) *1	Pushbutton color symbol	Minimum packing unit
SPDT	LED	5 VDC		A165L-Δ□M-5D-1P	R: red Y: yellow PY: pure yellow G: green A: blue W: white B: black *2	5 pcs
		12 VAC/VDC		A165L-Δ□M-12D-1P		
		24 VAC/VDC		A165L-Δ□M-24D-1P		
	Non-lighted			A165-Δ□M-1P		
DPDT	LED	5 VDC		A165L-Δ□M-5D-2P		
		12 VAC/VDC		A165L-Δ□M-12D-2P		
		24 VAC/VDC		A165L-Δ□M-24D-2P		
	Non-lighted			A165-Δ□M-2P		

Note: Contact your OMRON representative about Selector Switches and Key Selector Switches.

*1. Enter the desired shape for the Pushbutton in Δ: J (rectangular), A (square), or T (round). Enter the desired color symbol for the Pushbutton in the □.

*2. Black ("B") Pushbuttons are only available for non-lighted models.

A16 -P

Pushbutton Switch (Detachable) (Lighted/Non-Lighted) (Cylindrical 16-dia.)

Specifications

Approved Standard Ratings

- UL, cUL (File No. E41515)

5 A at 125 VAC, 3 A at 250 VAC (general use)
3 A at 30 VDC (resistive)

Note: Certification has been obtained for the Socket Unit.

- TÜV (EN60947-5-1)
(Low Voltage Directive)

3 A at 250 VAC
3 A at 30 VDC

- CCC (GB14048.5)

5 A at 125 VAC
3 A at 250 VAC
3 A at 30 VDC

Ratings

Contacts

Rated voltage	Resistive load
125 VAC	5
250 VAC	3
30 VDC	3

Minimum applicable load: 1 mA at 5 VDC

Rated values are obtained from tests conducted under the following conditions.

- Load: Resistive load
- Mounting conditions: No vibration and no shock
- Temperature: 20 ±2°C
- Operating frequency: 20 operations/min

Contact Form

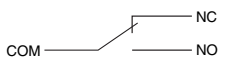
Name	Contact
Double-throw	

Characteristics

Item	Type	Pushbutton Switch
Allowable operating frequency	Mechanical	Momentary operation: 120 operations/minute max. Alternate operation: 60 operations/minute max. *1
	Electrical	20 operations/minute max. *1
Insulation resistance		100 MΩ min. (at 500 VDC)
Dielectric strength	Between terminals of same polarity	1,000 VAC, 50/60 Hz for 1 minute
	Between terminals of different polarity	2,000 VAC, 50/60 Hz for 1 minute
	Between each terminal and ground	2,000 VAC, 50/60 Hz for 1 minute
	Between lamp terminals	1,000 VAC, 50/60 Hz for 1 minute *2
Vibration resistance	Malfunction	10 to 55 Hz, 1.5-mm double amplitude (malfunction within 1 ms)
Shock resistance	Destruction	500 m/s ²
	Malfunction	150 m/s ² max. (malfunction within 1 ms)
Durability	Mechanical	Momentary operation: 2,000,000 operations min. Alternate operation: 200,000 operations min. *1
	Electrical	100,000 operations min. *1
Electric shock protection class		Class II
PTI (tracking characteristic)		175
Degree of contamination		3 (IEC947-5-1)
Weight		Approx. 12 g (in the case of a lighted DPDT switch with solder terminals)
Ambient operating temperature		-10°C to +55°C (with no icing or condensation)
Ambient operating humidity		35% to 85%RH
Ambient storage temperature		-25°C to +65°C (with no icing or condensation)

*1. Set and reset constitute one operation.

*2. With LED and incandescent lamp not mounted.

Dimensions

(Unit: mm)

Rectangular A16 -J - - P

PCB terminals

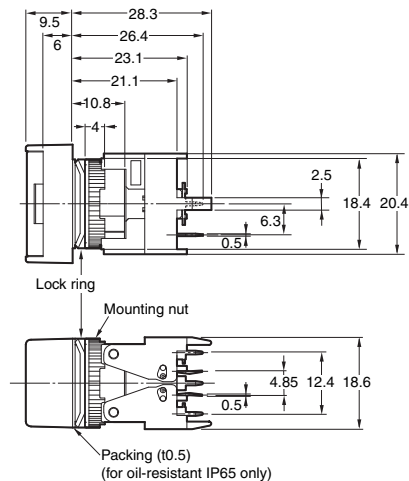
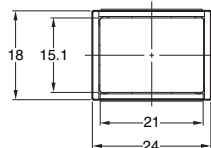
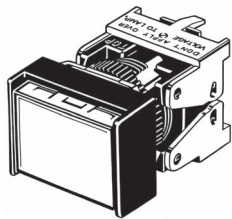

- The Dimension shows 1-switch output.
- The lamp terminal is also provided with non-lighted models.
- A rectangular model is listed as an example.
- Unless specified, there is a tolerance of ±0.4mm for dimensions.

Terminal Arrangement

● **PCB Terminals** (Lamp terminals are also present on non-lighted models.)

Lighted SPDT Switches	Lighted DPDT Switches
<p style="text-align: center;">Terminal Arrangement (Bottom View) Side with TOP indicated</p> <p style="text-align: center;">Dimensions of PCB Terminals</p> <p style="text-align: center;">PCB Cutouts (Bottom View)</p> <p>A = 24 min.: Rectangular A = 21 min.: Square or round L = 24 min. Dimensions of A and L shall match the Panel cutouts. Use t = 1.6 for the PCB.</p> <p>Note: Secure the panel to the board using stud bolts if force will be applied to the board after wiring.</p>	<p style="text-align: center;">Terminal Arrangement (Bottom View) Side with TOP indicated</p> <p style="text-align: center;">Dimensions of PCB Terminals</p> <p style="text-align: center;">PCB Cutouts (Bottom View)</p> <p>A = 24 min.: Rectangular A = 21 min.: Square or round L = 24 min. Use a PCB with a thickness of 1.6 mm.</p> <p>Note: Secure the panel to the board using stud bolts if force will be applied to the board after wiring.</p>

Panel Cutouts

● **PCB Terminals**

Rectangular A16□-J/M16□-J	Square A16□-A/M16□-A Round A16□-T/M16□-T
<p>(Top View)</p>	<p>(Top View)</p>
<p>Note: · Make sure the thickness of the mounting panel is between 0.5 and 3.2 mm. If, however, a Switch Guard or Dust Cover is used, the thickness of the mounting panel must be between 0.5 and 2 mm. · If the panel is to be finished with coating, etc., make sure that the panel meets the specified dimensions after coating.</p>	

Precautions

● Refer to the **Common Precautions for Pushbutton Switches** for common precautions.

● **Mounting multiple PCB Terminal Pushbutton Switches**
Be careful with the pitch between the centers of mounting holes when mounting multiple PCB Terminal Pushbutton Switches, otherwise the Switches may be , resulting in malfunction.

Mounting Hole Dimensions of PCB Cutouts (Bottom View)

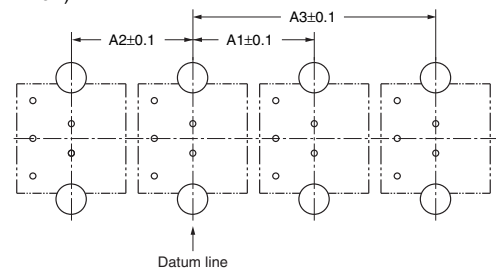

Mounting Hole Dimensions of the Panel Cutouts (Top View)

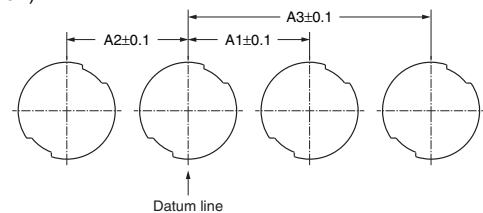

• Application examples provided in this document are for reference only. In actual applications, confirm equipment functions and safety before using the product.
• Consult your OMRON representative before using the product under conditions which are not described in the manual or applying the product to nuclear control systems, railroad systems, aviation systems, vehicles, combustion systems, medical equipment, amusement machines, safety equipment, and other systems or equipment that may have a serious influence on lives and property if used improperly. Make sure that the ratings and performance characteristics of the product provide a margin of safety for the system or equipment, and be sure to provide the system or equipment with double safety mechanisms.

Note: Do not use this document to operate the Unit.

OMRON Corporation

ELECTRONIC AND MECHANICAL COMPONENTS COMPANY

Contact: www.omron.com/ecb

**Cat. No. A116-E1-04
0812(0207)(O)**