

HD-22 Front Metal-Shell Right-Angle Posted Connectors 350 Mount

Receptacle

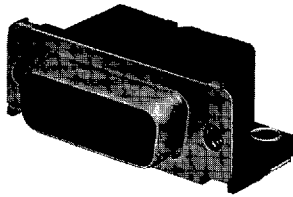

With Boardlock and Threaded Insert



With Female Screwlock

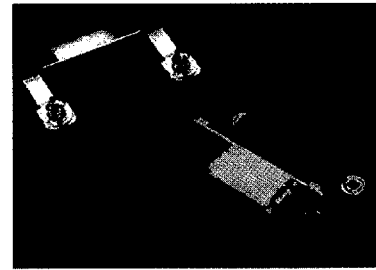
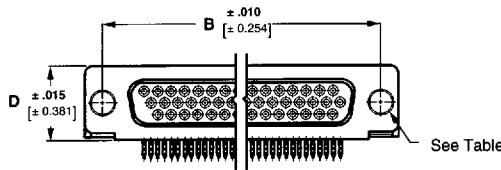
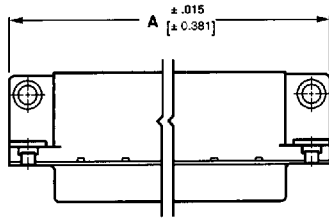

15-Position Receptacle, per VESA/VGA Standard with 4-40 Threaded Inserts or Female Screwlocks and Boardlocks, Blue Thermoplastic Housing

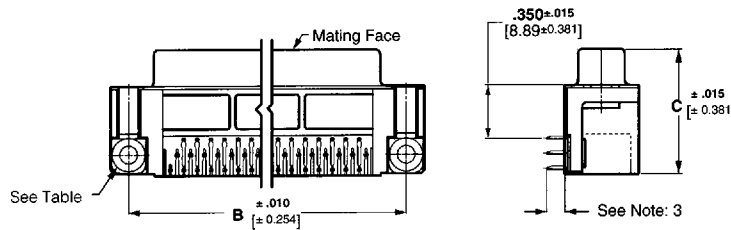

Material and Finish:

Front Shell—Steel, tin plated

Housing—94V-0 rated thermoplastic, black

▲ VESA Std. 15-position Receptacle Housing Material—Thermoplastic 94V-0 blue per VESA Std.

Eyelets—Brass, tin or tin-lead plated

Threaded Inserts—Zinc

Female Screwlocks—Zinc

Socket Contacts (Posted)—Phosphor bronze

Contact Finish—Duplex plated:

A—.000030 [0.00076] gold on mating end, tin-lead on termination end, with entire contact nickel underplated

B—Gold flash on mating end, tin-lead on termination end, with the entire contact nickel underplated

Related Product Data:

Contact Arrangements—page 4

Performance Characteristics—page 5

Mateable Connectors:

HDP-22—pages 8-14

Mating/Panel Mounting—page 6

Pc Board Mounting Specifications—page 170

Technical Documents:

Product Specification—108-1092

Application Specification—114-10021

Shell Size	No. of Contact Positions	Dimensions				Contacts Finish (Plating Code)	Receptacle Part Numbers		
		A	B	C	D		Boardlocks		.125 [3.18] Dia. Holes
							Threaded Inserts	Female Screwlocks	Threaded Inserts
▲1	15 VESA/VGA	1.222	.984	.836	.494	A	787066-1	787506-1	—
		31.04	24.99	21.23	12.55	B	787066-2	—	—
1	15	1.222	.984	.836	.494	A	748390-5	748390-6	—
		31.04	24.99	21.23	12.55	B	1-748390-1	1-748390-2	—
						A	3-748390-8	4-748390-2	—
						B	4-748390-1	—	—
2	26	1.550	1.312	.836	.494	A	748481-5	748481-6	1-748481-9
		39.37	33.33	21.23	12.55				
3	44	2.090	1.852	.836	.494	A	748482-5	—	—
		53.09	47.04	21.23	12.55				
4	62	2.738	2.500	.836	.494	A	748394-5	748394-6	—
		69.55	63.50	21.23	12.55				
5	78	2.644	2.406	.936	.605	A	748483-5	748483-6	—
		67.16	61.11	23.77	15.37				

- Notes:**
- All receptacle connectors are preloaded with size 22 DF posted socket contacts
 - Recommended pc board thickness is .062 [1.58] for connectors with boardlocks and .093 [2.36] max. for all others.
 - Tail Length .125±.020 [3.18±0.51] except Part Nos. 3-748390-8, 4-748390-1 and 4-748390-2 tail length .085±.010 [2.16±2.54]

For drawings, technical data or samples, contact your AMP sales engineer or call the AMP Product Information Center: 1-800-522-6752. Dimensions are in inches and millimeters unless specified otherwise. Values in brackets are metric equivalents. Specifications subject to change. Consult AMP Incorporated for latest specifications.

HD-22 and HD-20 Commercial Connectors (AMPLIMITE)

Contact Arrangements

HD-22 Inserts

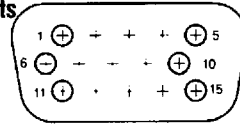

Shell Size 1
(15 Position)

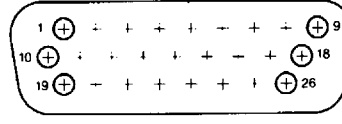

Shell Size 2
(26 Position)

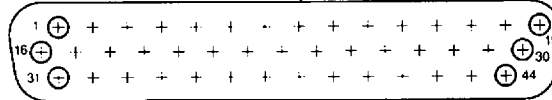

Shell Size 3
(44 Position)

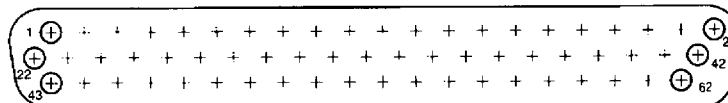

Shell Size 4
(62 Position)

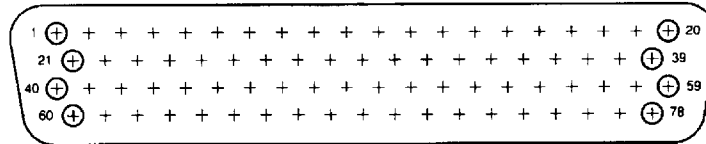

Shell Size 5
(78 Position)

HD-20 Inserts

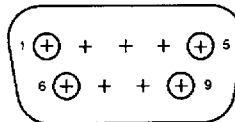

Shell Size 1
(9 Position)

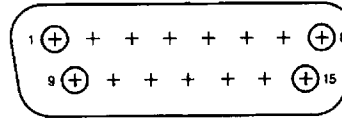

Shell Size 2
(15 Position)

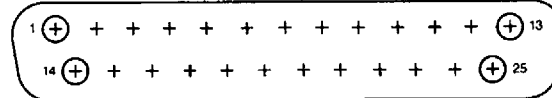

Shell Size 3
(25 Position)

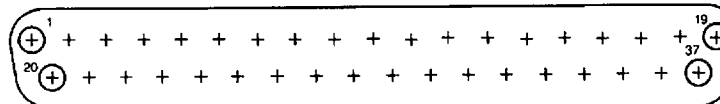

Shell Size 4
(37 Position)

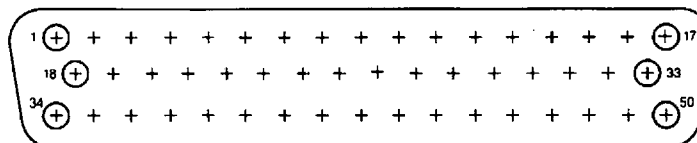

Shell Size 5

(50 Position—This cavity identification numbering does not apply to the 50 position HDF-20 connector, see next illustration.)

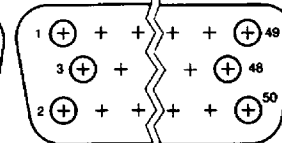

Shell Size 5

(50 Position—HDF-20 connector)

Note: Mating face of plug is shown, receptacle is mirror-image.

HD-22 and HD-20 Connectors Performance Characteristics

Cable Connectors

	Connector Type			
	HDP-22	HDE-20	HDF-20	HDP-20
Electrical Characteristics				
Contact Current Rating (One pair of contacts)	22 AWG [0.4mm ²] Wire 5.0 amperes	20 AWG [0.6mm ²] 3 amperes	26 & 28 AWG [0.15 & 0.08mm ²] Stranded and Solid Wire 1.25 amperes	20 AWG [0.6mm ²] 7.5 amperes
Termination Resistance	15 milliohms (max.)	30 milliohms (max.)	25 milliohms (max.)	15 milliohms (max.)
Dielectric Withstanding Voltage	1000 VAC min.	1000 VAC min.	500 VAC min.	1000 VAC min.
Insulation Resistance	5000 megohms min.	5000 megohms min.	5000 megohms min.	5000 megohms min.
Mechanical Characteristics				
Contact Insertion Force	3 lb. max. [13.34 N max.]	N/A	N/A	3 lb. max. [13.34 N max.]
Contact Retention	5 lb. min. [22.24 N min.]	7 lb. min. [31.14 N min.]	N/A	10 lb. min. [44.48 N min.]
Contact Mating Force (Per contact circuit pair)	8 oz. max. [2.22 N max.]	8 oz. max. [2.22 N max.]	12 oz. max. [3.34 N max.]	8 oz. max. [2.22 N max.]
Contact Unmating Force (Per contact circuit pair)	.75 oz. min. [0.209 N min.]	.75 oz. min. [0.209 N min.]	9-37 Position .75 oz. min. [0.209 N min.] 50 Position .40 oz. min. [0.111 N min.]	.75 oz. min. [0.209 N min.]
Tensile Strength	22 AWG—12 lb. [0.4mm ² —53.4 N] 24 AWG—8 lb. [0.2mm ² —35.6 N] 26 AWG—4.5 lb. [0.15mm ² —20.02 N] 28 AWG—2.7 lb. [0.08mm ² —12.01 N]	20 AWG—9.5 lb. [0.6mm ² —42.3 N] 22 AWG—6 lb. [0.4mm ² —26.7 N] 24 AWG—4 lb. [0.2mm ² —17.79 N] 26 AWG—2.5 lb. [0.15mm ² —11.12 N] 28 AWG—2.5 lb. [0.08mm ² —11.12 N] 30 AWG—1 lb. [0.05mm ² —4.45 N]	N/A	20 AWG—20 lb. [0.6mm ² —89 N] 22 AWG—12 lb. [0.4mm ² —53.4 N] 24 AWG—8 lb. [0.2mm ² —35.6 N] 26 AWG—4.5 lb. [0.15mm ² —20.02 N] 28 AWG—2.7 lb. [0.08mm ² —12.01 N]
Durability	.000030 [0.00076] gold—500 cycles Gold Flash— 100 cycles	.000030 [0.00076] gold—500 cycles Gold Flash— 100 cycles	.000030 [0.00076] gold—500 cycles	.000030 [0.00076] gold—500 cycles Gold Flash— 100 cycles
Environmental Characteristics				
Vibration	Random 20 G's rms max.	Random 20 G's rms max.	Random 16.4 G's rms max.	Random 20 G's rms max.
Physical Shock	50 G's Duration 11 ms	50 G's Duration 11 ms	50 G's Duration 11 ms	50 G's Duration 11 ms

Board Mount Connectors

	Connector Type	
	HD-22	HD-20
Electrical Characteristics		
Single Contact Current Rating (30°C Rise) Duration 11 ms	2.0 amperes	18 AWG 6.0 amperes 24 AWG 4.3 amperes 28 AWG 2.9 amperes
Termination Resistance	20 milliohms (max.)	15 milliohms* (max.)
Dielectric Withstanding Voltage	1000 VAC min.	1000 VAC min.**
Insulation Resistance	5000 megohms min.	5000 megohms min.

*Stacked Connectors—30 milliohms (max.)

**Stacked Connectors—500 VAC min.

	Connector Type		
	HD-22	HD-20	HD-20
Mechanical Characteristics			
Durability	.000030 [0.00076] gold—500 cycles Gold flash— 100 cycles	.000030 [0.00076] gold—500 cycles Gold flash— 100 cycles	.000030 [0.00076] gold—500 cycles Gold flash— 100 cycles
Connector Mating and Unmating Force (lbs. max. over [N max.])	Size	HD-22 Without Grounding Indents	HD-20 Without Grounding Indents
	1	7.5 [33.4]	4.5 [20.02]
	2	13.0 [57.8]	7.5 [33.4]
	3	22.0 [97.9]	12.5 [55.6]
	4	31.0 [137.9]	18.5 [82.3]
	5	39.0 [173.5]	25.0 [111.2]
			HD-20 With Grounding Indents
			30.0 [133.5]
			33.0 [146.8]
			37.0 [164.6]
			40.0 [177.9]
			44.0 [195.7]

Plug/Receptacle Mating and Panel Mounting Specifications

Plug/Receptacle Mating

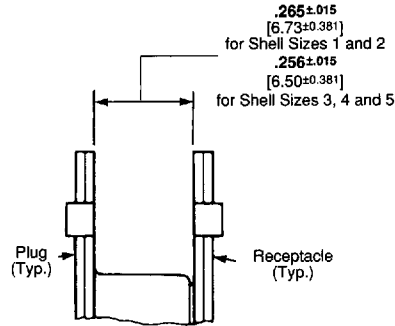

The .265 [6.73] dimension is required to assure full mating of connector halves. This dimension must be taken into consideration when determining the method of mounting, panel thickness, etc.

Panel Mounting

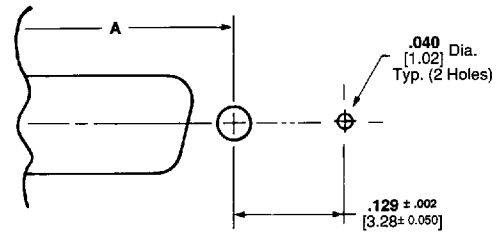
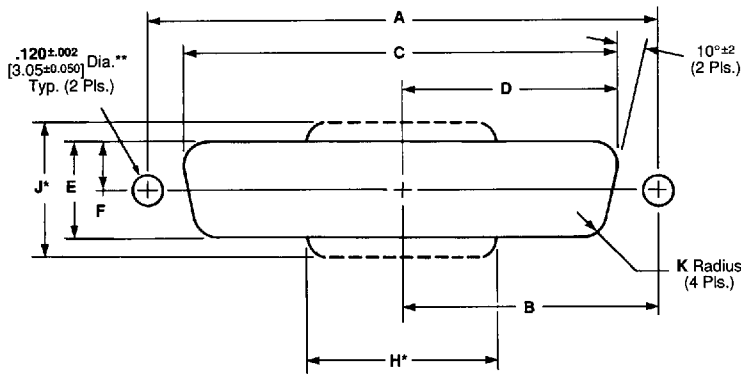

Cutout for Rear Mount and Short Latching Block

Note: Cutouts are for either plug or receptacle, front or rear panel mount.

Most plugs and receptacles can be mounted to a panel from either the front or rear, using a variety of accessory hardware. Posted receptacles are rear panel mounted only. Typical examples are shown below.

Shell Size (Pos.)	Mounting Method Front/Rear Panel	Dimensions								
		A	B	C	D	E	F	H*	J*	K
1 (9)	Front	.984 24.99	.492 12.50	.874 22.20	.437 11.10	.513 13.03	.257 6.53	—	—	.083 2.11
	Rear	.984 24.99	.492 12.50	.806 20.47	.403 10.24	.449 11.41	.225 5.72	.550 13.97	.750 19.05	.132 3.35
2 (15)	Front	1.312 33.33	.656 16.66	1.202 30.53	.601 15.27	.513 13.03	.257 6.53	—	—	.083 2.11
	Rear	1.312 33.33	.656 16.66	1.134 28.80	.567 14.40	.449 11.41	.225 5.72	.730 18.54	.750 19.05	.132 3.35
3 (25)	Front	1.852 47.04	.926 23.52	1.743 44.27	.872 22.15	.513 13.03	.257 6.53	—	—	.083 2.11
	Rear	1.852 47.04	.926 23.52	1.674 42.52	.842 21.39	.449 11.41	.225 5.72	1.275 32.39	.750 19.05	.132 3.35
4 (37)	Front	2.500 63.50	1.250 31.75	2.391 60.73	1.196 30.38	.513 13.03	.257 6.53	—	—	.083 2.11
	Rear	2.500 63.50	1.250 31.75	2.326 59.08	1.163 29.54	.449 11.41	.225 5.72	1.920 46.05	.750 16.13	.132 3.35
5 (50)	Front	2.406 61.11	1.203 30.56	2.297 58.34	1.149 29.19	.623 15.82	.312 7.93	—	—	.083 2.11
	Rear	2.406 61.11	1.203 30.56	2.218 56.34	1.109 28.17	.555 14.10	.278 7.06	1.753 44.52	.750 19.05	.132 3.35

*Panel cutout configuration with H and J dimensions provides clearance for mounting connectors with cable clamps.
**This dimension is .190 ± .002 [4.83 ± 0.05] when posted connectors with fixed female screwlocks are rear-panel mounted.

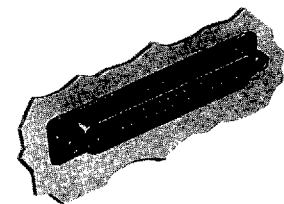

Typical Front-Panel Mounted Subminiature D Plug

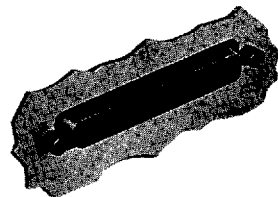

Typical Rear-Panel Mounted Subminiature D Receptacle