

SERIES 50 SERIES 51

0.5" Diameter, 200mA,
.698" Behind Panel

FEATURES

- Optional Complete Seal for PC Board Assembly and Cleaning
- Small 1/2" Diameter
- Choice of 22.5°, 30°, 36°, 45°, 60° and 90° Angles of Throw
- Up to 4 Poles on 1 Deck
- Up to 16 Positions Per Switch
- PC or Solder Lug Termination
- Positive Shaft Grounding for EMI/RFI Shielding



DIMENSIONS In inches (and millimeters)

PC Mount Style

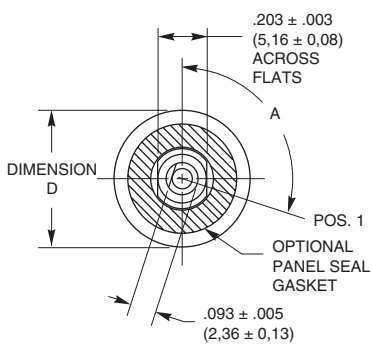

Grayhill part number and date code marked on label. Customer part number marked on request. Military part number marked when required.

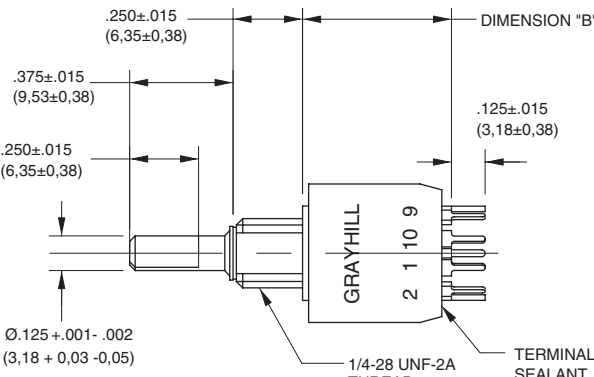

PC TERMINAL DETAIL
All angles of throw, except 22.5°

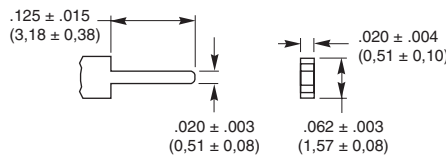

Side View
All others as shown at left

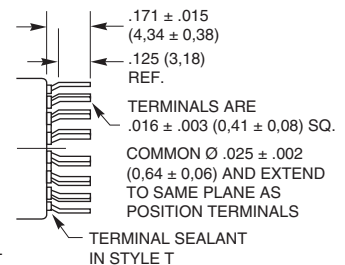

PC COMMON DETAIL
All angles of throw, except 22.5°

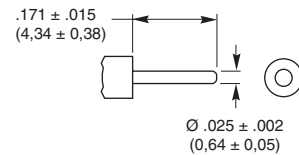

Angle of Throw	Angle A	Angle of Throw	Angle A
22.5°	101.25°	45°	112.5°
30°	105°	60°	120°
36°	108°	90°	135°

Dimension	Series 50	Series 51
D	.500 ± .015 (12,70 ± 0,38)	.562 ± .015 (14,27 ± 0,38)

Dimension	Style T	All Others	All 22.5°
B	.576 ± .015 (14,63 ± 0,38)	.537 ± .015 (13,64 ± 0,38)	.537 ± .015 (13,64 ± 0,38)

Solder Lug Style

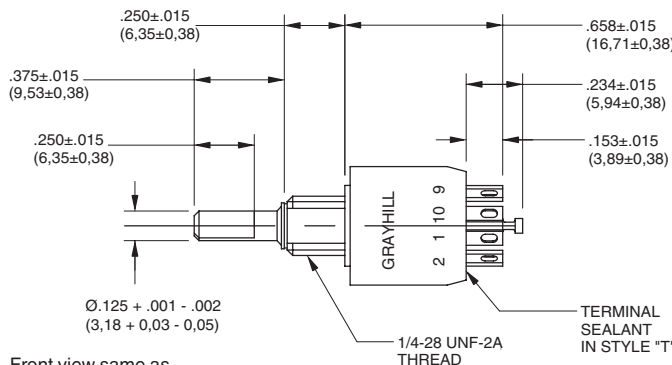

Front view same as PC Mount style.

SOLDER LUG TERMINAL DETAIL
All angles of throw, except 22.5°

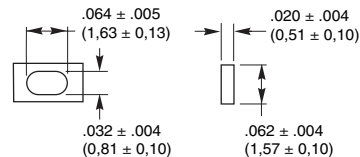

SOLDER LUG TERMINAL DETAIL 22.5°

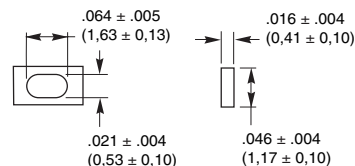

CIRCUIT DIAGRAMS AND REAR VIEWS: Solder Lug and PC Mount

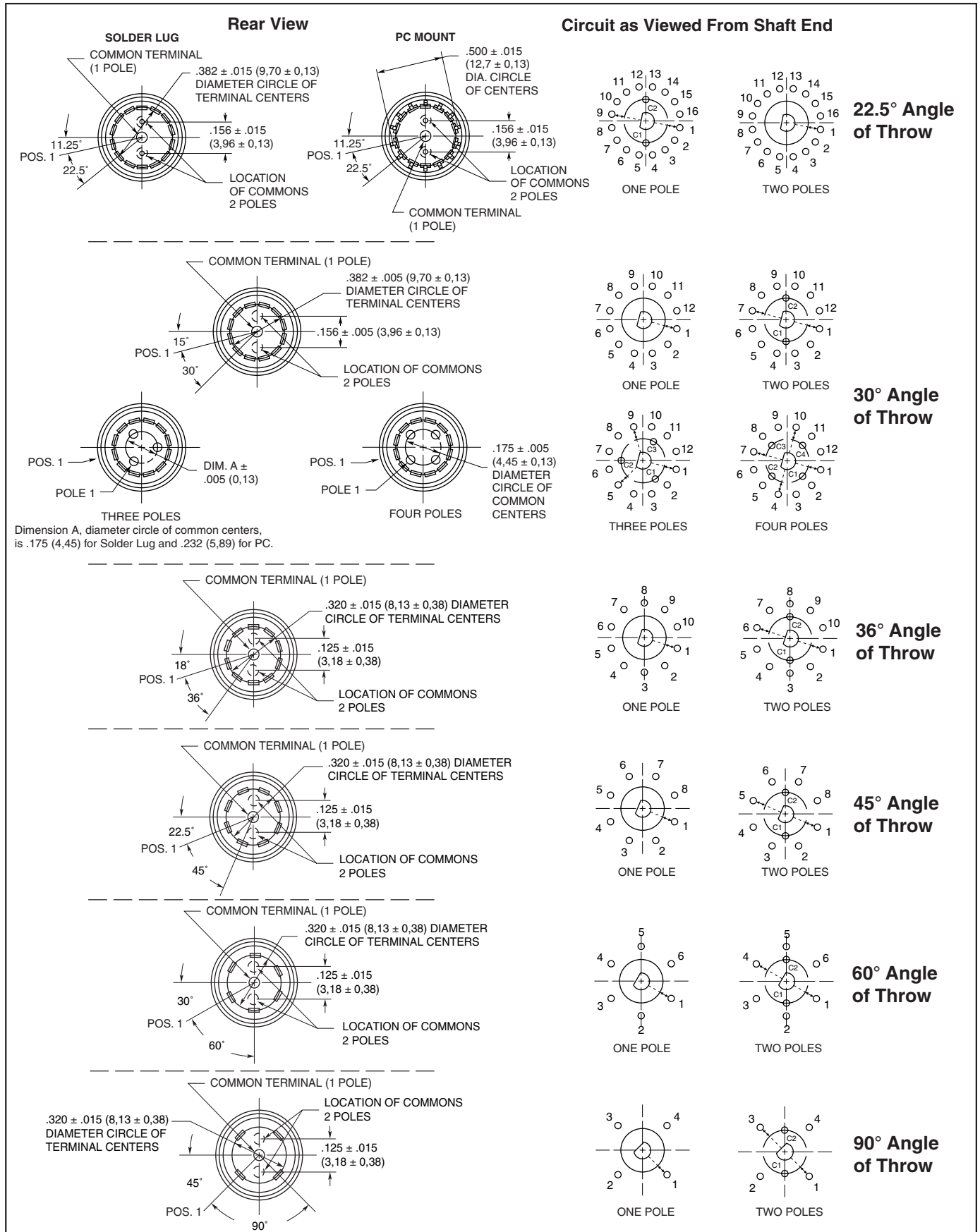

Rotary Switches

SPECIFICATIONS

Military Qualification

The dimensions for qualified switches are the same as those indicated in the drawings of standard switches. Switches with standard variations, such as shaft and bushing length, which do not affect switch performance, can be marked as qualified product. Contact Grayhill for complete information on variations.

36°, 45°, 60°, 90° (Series 50): The C and M style switches are qualified to MIL-S-3786/20. They include the following:
Solder lug or PC terminals
With or without panel seal

Series 50 qualified switches may be ordered by the 'M' number or by the Grayhill part number.

30° (Series 51): The C and M style switches are qualified to MIL-S-3786/35. They include the following:
Solder lug or PC terminals
With or without panel seal

Series 51 qualified switches may be ordered by the 'M' number or by the Grayhill part number.

Electrical Ratings

Life Expectancy: With the limiting criteria stated here, the Series 50 and 51 with non-shorting contacts will switch the following loads at atmospheric and reduced pressures for 25,000 cycles of operations. One cycle is 360° rotation clockwise and 360° return.

At 85°C, atmospheric pressure	
200 mA,	28 Vdc resistive
150 mA,	115 Vac resistive
30 mA,	28 Vdc inductive
100 mA,	28 Vdc lamp load
75 mA,	220 Vac lamp load

At 25°C, reduced pressure (70,000 feet)	
200 mA,	28 Vdc resistive
150 mA,	115 Vac resistive
75 mA,	220 Vac resistive

Contact Resistance: 20 milliohms maximum, (10 milliohms initially).

Insulation Resistance: 1,000 Mohms minimum between mutually insulated parts.

Voltage Breakdown: 600 Vac minimum between mutually insulated parts at standard atmospheric pressure.

Life Expectancy: Listed for the voltage source and make and break current levels. Contact Grayhill for more information if any of the following is true: the life limiting criteria are more critical than those listed; longer operation is required; a larger make and break current is required; the operating environment includes elevated temperatures or reduced pressures.

Contact Carry Rating: Switch will carry 6 amperes continuously with a maximum contact temperature rise of 20°C.

SPECIFICATIONS: Other

Additional Characteristics

Contact Type and Forces: Shorting or non-shorting wiping contacts with over 80 grams of contact force.

Shaft Flat Orientation: Flat opposite contacting position of pole number one (see circuit diagrams).

Terminals: Switches have the full circle of terminals, regardless of number of active position.

Stop Strength: 7.5 pound-inches minimum

Rotational Torque: 8–24 ounce-inches, depending on the number of poles.

Materials and Finishes

Switch Base: Thermoset

Detent Rotor: Nylon

Shaft, Stop Blades, Stop Arm, Thrust washer, and Retaining Ring: Stainless steel

Detent Balls: Steel, nickel-plated

Bushing: Zinc, tin-zinc plated

Detent and Contact Springs: Stainless steel

Common Ring: Brass, gold-plated over silver plate.

Terminals: Brass, gold-plated over silver plate and nickel plate

Rotor Contact: Precious metal alloy, gold-plated

Panel Seal: Silicone rubber

Shaft Seal: Fluorosilicone

Mounting Nuts: Brass, tin-zinc plated

Mounting Hardware: One mounting nut .089" thick by .375" across flats and one internal tooth lockwasher are supplied with the switch.

Maximum Mounting Torque: 15in-lbs

PROCESS SEALED–Style T

Switch can be mounted on PC board with other components and subjected to wave soldering and conventional board cleaning techniques. No secondary wiring or soldering is necessary.

Bushing is o-ring sealed; epoxy potting seals the terminals and the rear of the switch. Designed for PC assembly, this sealing technique can also be applied to solder lug terminal switches. A bushing to panel seal can also be added to the process sealed versions. Military qualified versions are available, see ordering information.

1/4" SHAFT: Style K

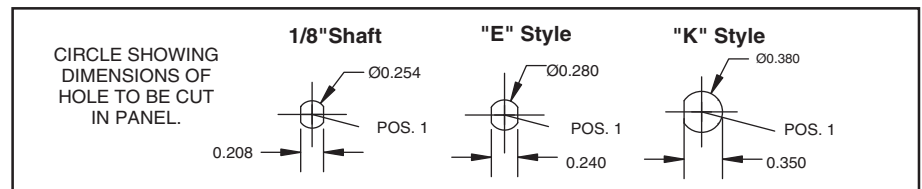
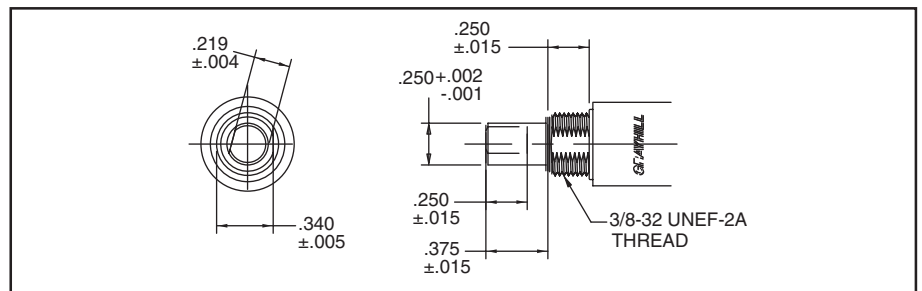

SUGGESTED ADJUSTABLE STOP SUBSTITUTION GUIDE

Fixed Stop Style	Adj. Stop Style Equivalent	Fixed Stop Style	Adj. Stop Style Equivalent
50A	50D	51A	51D
50C	50CD	51C	51CD
50CP	50CDP	51CP	51CDP
50M	50CD*	51M	51CD*
50MP	50CDP*	51MP	51CDP*
50P	50DP	51P	51DP
50S	50D*	51S	51D*
50SP	50DP*	51SP	51DP*

*Form fit and function equivalents, but not watertight sealed to the panel.

ADJUSTABLE STOPS: Style D

Adjustable stops permit the user to set and reset the number of positions per poles. Shown in the diagram, a plastic washer can be removed to reveal slots at the base of the bushing. Stop blades can be inserted into the appropriate slots to limit switch rotation. Positions per pole configuration can thus be changed to meet the needs of the application. Dimensions are the same as the fixed stop version, when plastic washer is in place. Most desirable for prototype work. Readily available from local distributor.

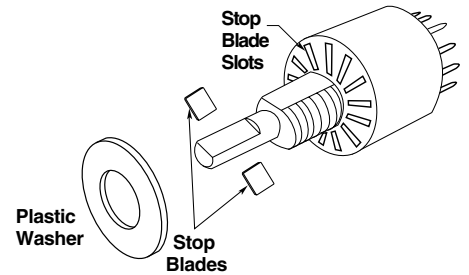

SHAFT AND PANEL SEAL: Styles S and M

Shaft and panel seal switches are watertight to the panel. They are not totally process sealed like the Style "T". Panel is sealed by a gasket at the base of the bushing. Shaft is sealed by an O-ring inside the bushing. After mounting, seals do not alter switch dimensions. See Style "S" (standard switches) and Style "M" (military switches) in the Choices and Limitations chart.

SCREWDRIVER SLOTTED SHAFT: Style B

Form, fit and function equivalent to standard shaft switches. The dimensions shown have evolved as the most popular for this type of switch. See Style "B" in the Choices and Limitations chart. Previous users may have ordered these switches by a non-descriptive part number containing a "Y". Contact Grayhill, if in doubt about a cross-reference.

METRIC SHAFT AND BUSHING: Style E

Metric standard dimensions for the shaft and bushing are shown in the drawing. Other dimensions approximately the same as shown in dimensional drawing. Contact Grayhill for exact dimensions. See Style "E" in the Choices and Limitations chart.

ACCESSORY: Non-Turn Washers

In Inches (and millimeters)

Part No. 50J1066

Cut round hole for the bushing and for the non-turn tab. Washer fits the double D bushing flats. Washer is sold only when accompanied by an order for a like number of switches. Washer is 302 stainless steel.

Dimensions are in millimeters

Part No. 71J1103

Designed to fit the double flatted bushing of the metric dimensioned bushing, this non-turn washer permits a round hole for the bushing and the tab while still preventing switch rotation. Washer is only sold when accompanied by a like number of switches. Washer is 302 stainless steel.

Part No. 50J5140-4

Designed to fit the single flatted bushing of the "K" style switches, this non-turn washer prevents switch rotation when using a full round hole in the panel. Washer is only sold when accompanied by a like number of switches. Washer is 302 stainless steel.

CHOICES AND LIMITATIONS: Series 50

A = Standard, 1/8" Shaft
 B = Screwdriver Slot Shaft
 C = Military, Without Panel Seal
 D = Adjustable Stop (Adj. Stop)

E = Metric, 4mm Shaft
 K = 1/4" Shaft
 M = Military

P = PC Mount Terminals
 S = Shaft/Panel Seal (S/P Seal)
 T = Process Sealed

Standard Style

Series	Style Choices ¹			Terminals	Angle of Throw	Number of Poles	Number of Positions Per Pole	Shorting or Non-Shorting Contacts
	Std., 1/8" Shaft	1/4" Shaft	Metric, 4mm Shaft					
50	A AT B BS BST BT D S ST	K KS KT KB KBS KBST KT	E ES EST ET EB EBS EBST EBT	Solder Lug	36°	1 2	02 thru 10 02 thru 05	N or S N or S
					45°	1 2	02 thru 08 02 thru 04	N N
					60°	1 2	02 thru 06 02 or 03	N N
					90°	1 2	02 thru 04 02	N N
	BP BPT BSP BSPT DP P PT SP SPT	KP KPT KSP KSPT KBP KBSP KBSPT KBT	EP EPT ESP ESPT EBP EBSP KBSPT EBT	PC Mount	36°	1 2	02 thru 10 02 thru 05	N or S N or S
					45°	1 2	02 thru 08 02 thru 04	N N
					60°	1 2	02 thru 06 02 or 03	N N
					90°	1 2	02 thru 04 02	N N

Military Style

Series	Style Choices			Terminals	Angle of Throw	Number of Poles	Number of Positions Per Pole	Shorting or Non-Shorting Contacts
	Std., 1/8" Shaft	1/4" Shaft	Metric, 4mm Shaft					
50	C CB CBT CD CT M MB MBT MT	KM KMB KMBT KMT	EM EMB EMBT EMT	Solder Lug	36°	1 2	02 thru 10 02 thru 05	N or S N or S
					45°	1 2	02 thru 08 02 thru 04	N N
					60°	1 2	02 thru 06 02 or 03	N N
					90°	1 2	02 thru 04 02	N N
	CBP CBPT CDP CP CPT MBP MBPT MP MPT	KMBP KMBPT KMP KMPT	EMBP EMBPT EMP EMPT	PC Mount	36°	1 2	02 thru 10 02 thru 05	N or S N or S
					45°	1 2	02 thru 08 02 thru 04	N N
					60°	1 2	02 thru 06 02 or 03	N N
					90°	1 2	02 thru 04 02	N N

CHOICES AND LIMITATIONS: Series 51

A = Standard, 1/8" Shaft
 B = Screwdriver Slot Shaft
 C = Military, Without Panel Seal
 D = Adjustable Stop (Adj. Stop)

E = Metric, 4mm Shaft
 K = 1/4" Shaft
 M = Military

P = PC Mount Terminals
 S = Shaft/Panel Seal (S/P Seal)
 T = Process Sealed

Standard Style

Series	Std., 1/8" Shaft	Style Choices ¹ 1/4" Shaft	Metric, 4mm Shaft ¹	Terminals	Angle of Throw	Number of Poles	Number of Positions Per Pole	Shorting or Non-Shorting Contacts
51	A AT B BT S ST BS BST	SEE BELOW	SEE BELOW	Solder Lug	22.5°	1 2	02 thru 16 02 thru 08	N or S N or S
	A AT B BT BS BST BT BT D D S ST ST ST	K KS KST KT	E ES EST ET	Solder Lug	30°	1 2 3 4	02 thru 12 02 thru 06 02 thru 04 02 or 03	N or S N or S N or S N or S
	P PT BP BPT SP SPT BSP BSPT	SEE BELOW	SEE BELOW	PC Mount	22.5°	1 2	02 thru 16 02 thru 08	N or S N or S
	BP BPT BSP BSPT DP DP P P PT PT SP SP SPT SPT	KP KPT KSP KSPT	EP EPT ESP ESPT	PC Mount	30°	1 2 3 4	02 thru 12 02 thru 06 02 thru 04 02 or 03	N or S N or S N or S N or S

Military Style

Series	Std., 1/8" Shaft	Style Choices 1/4" Shaft	Metric, 4mm Shaft	Terminals	Angle of Throw	Number of Poles	Number of Positions Per Pole	Shorting or Non-Shorting Contacts
51	C CB CBT CBT CD CD CT CT M M MB MB MBT MBT MT MT	KM KMB KMBT KMT	EM EMB EMBT EMT	Solder Lug	30°	1 2 3 4	02 thru 12 02 thru 06 02 thru 04 02 or 03	N or S N or S N or S N or S
	CBP CBP CBPT CBPT CDP CDP CP CP CPT CPT MBP MBP MBPT MBPT MP MP MPT MPT	KMBP KMBPT KMP KMPT	EMBP EMBPT EMP EMPT	PC Mount	30°	1 2 3 4	02 thru 12 02 thru 06 02 thru 04 02 or 03	N or S N or S N or S N or S

¹ Contact Grayhill if 1/4" or metric shaft required with a 22.5° angle of throw.

ADDITIONAL FEATURES

Economy keylock switch, isolated position, spring return, and coded switches are available in similar series. See Keylock and Special Function Rotary Switch sections.

Available from your local Grayhill Distributor.

For prices and discounts, contact a local Sales Office, an authorized local Distributor, or Grayhill.

ORDERING INFORMATION: Series 50

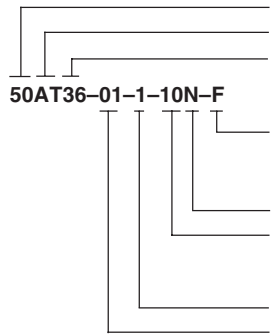

Series: Series 50 (36°, 45°, 60°, or 90°)
Style*: Letters from Choices Chart
Angle of Throw: 36, 45, 60, or 90

Stop Arrangement: *Needed only with 1 pole switches with maximum positions.* Leave blank for continuous rotation; add F for fixed stop.
Type of Contacts: N = Non-shorting, S = Shorting
Positions Per Pole: 02 as a minimum to the maximum allowable for the angle of throw and the number of poles per the Choices Chart. Use Letters AJ in this location if adjustable stop switch is ordered.
Poles per Deck: See chart
Number of Decks: 01 only

* All rotary switches that are required to have military designated markings and testing adhering to MIL-3786 are to be ordered by specifying the military part number identified on the appropriate slash sheet.

ORDERING INFORMATION: Series 51

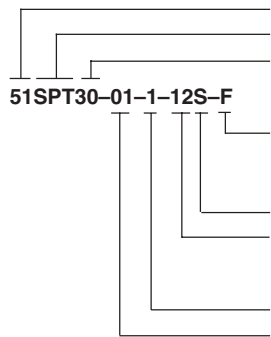

Series: Series 51 (30°; 22.5°)
Style*: Letters from Choices Chart
Angle of Throw: Use 22 (for 22.5°), 30

Stop Arrangement: *Needed only with 1 pole switches with maximum positions.* Leave blank for continuous rotation; add F for fixed stop.
Type of Contacts: N = Non-shorting, S = Shorting
Positions Per Pole: 02 as a minimum to the maximum allowable for the angle of throw and the number of poles per the Choices Chart. Use Letters AJ in this location if adjustable stop switch is ordered.
Poles per Deck: See chart
Number of Decks: 01 only

* All rotary switches that are required to have military designated markings and testing adhering to MIL-3786 are to be ordered by specifying the military part number identified on the appropriate slash sheet.