3SK298

Silicon N-Channel Dual Gate MOS FET

HITACHI

ADE-208-390
1st. Edition

Application

UHF / VHF RF amplifier

Features

- Low noise figure.
NF = 1.0 dB typ. at $f = 200$ MHz
- Capable of low voltage operation

Outline

CMPAK-4

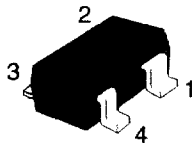

1. Source
2. Gate1
3. Gate2
4. Drain

Absolute Maximum Ratings (Ta = 25°C)

Item	Symbol	Ratings	Unit
Drain to source voltage	V_{DS}	12	V
Gate 1 to source voltage	V_{G1S}	± 8	V
Gate 2 to source voltage	V_{G2S}	± 8	V
Drain current	I_D	25	mA
Channel power dissipation	Pch	100	mW
Channel temperature	Tch	150	°C
Storage temperature	Tstg	-55 to +150	°C

Attention: This device is very sensitive to electro static discharge.

It is recommended to adopt appropriate cautions when handling this transistor.

Electrical Characteristics (Ta = 25°C)

Item	Symbol	Min	Typ	Max	Unit	Test conditions
Drain to source breakdown voltage	$V_{(BR)DSX}$	12	—	—	V	$I_D = 200 \mu A$, $V_{G1S} = -3 V$, $V_{G2S} = -3 V$
Gate 1 to source breakdown voltage	$V_{(BR)G1SS}$	± 8	—	—	V	$I_{G1} = \pm 10 \mu A$, $V_{G2S} = V_{DS} = 0$
Gate 2 to source breakdown voltage	$V_{(BR)G2SS}$	± 8	—	—	V	$I_{G2} = \pm 10 \mu A$, $V_{G1S} = V_{DS} = 0$
Gate 1 cutoff current	I_{G1SS}	—	—	± 100	nA	$V_{G1S} = \pm 6 V$, $V_{G2S} = V_{DS} = 0$
Gate 2 cutoff current	I_{G2SS}	—	—	± 100	nA	$V_{G2S} = \pm 6 V$, $V_{G1S} = V_{DS} = 0$
Drain current	$I_{DS(on)}$	0.5	—	10	mA	$V_{DS} = 6 V$, $V_{G1S} = 0.75 V$, $V_{G2S} = 3 V$
Gate 1 to source cutoff voltage	$V_{G1S(off)}$	0	—	+1.0	V	$V_{DS} = 10 V$, $V_{G2S} = 3 V$, $I_D = 100 \mu A$
Gate 2 to source cutoff voltage	$V_{G2S(off)}$	0	—	+1.0	V	$V_{DS} = 10 V$, $V_{G1S} = 3 V$, $I_D = 100 \mu A$
Forward transfer admittance	$ y_{fs} $	16	20	—	mS	$V_{DS} = 6 V$, $V_{G2S} = 3 V$, $I_D = 10 mA$, $f = 1 kHz$
Input capacitance	Ciss	2.4	2.9	3.4	pF	$V_{DS} = 6 V$, $V_{G2S} = 3 V$, $I_D = 10 mA$, $f = 1 MHz$
Output capacitance	Coss	0.8	1.0	1.4	pF	
Reverse transfer capacitance	Crss	—	0.023	0.04	pF	
Power gain	PG	22	25	—	dB	$V_{DS} = 6 V$, $V_{G2S} = 3 V$, $I_D = 10 mA$, $f = 200 MHz$
Noise figure	NF	—	1.0	1.8	dB	
Power gain	PG	12	15	—	dB	$V_{DS} = 6 V$, $V_{G2S} = 3 V$, $I_D = 10 mA$, $f = 900 MHz$
Noise figure	NF	—	3.2	4.5	dB	
Noise figure	NF	—	2.8	3.5	dB	$V_{DS} = 6 V$, $V_{G2S} = 3 V$, $I_D = 10 mA$, $f = 60 MHz$

Note: Marking is "ZP—"

Maximum Channel Power Dissipation Curve

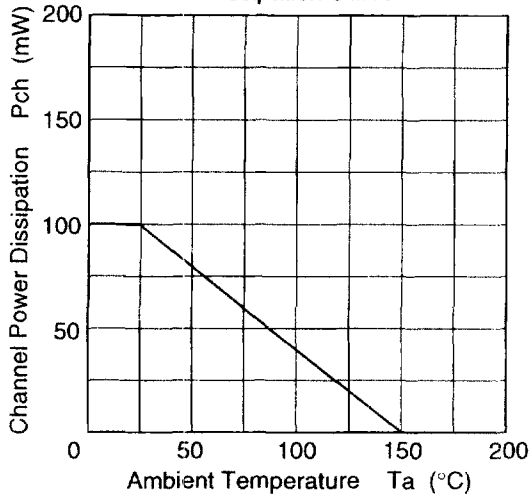

Typical Output Characteristics

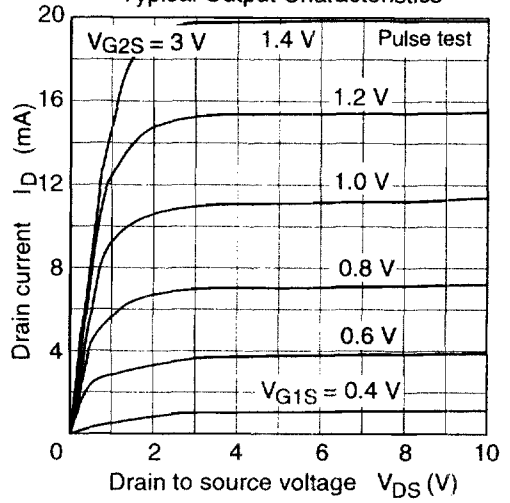

Drain Current vs. Gate1 to Source Voltage

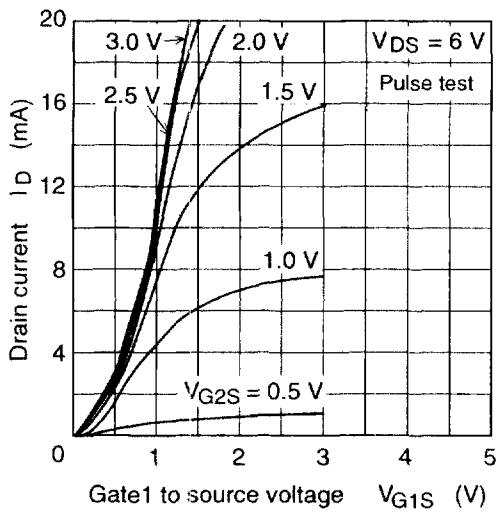

Drain Current vs. Gate2 to Source Voltage

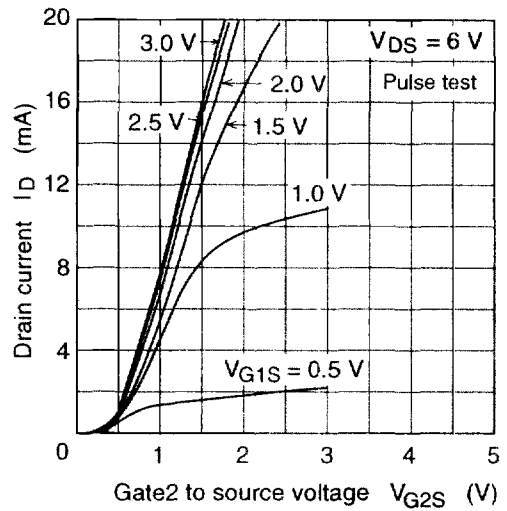

Forward Transfer Admittance vs. Gate1 to Source Voltage

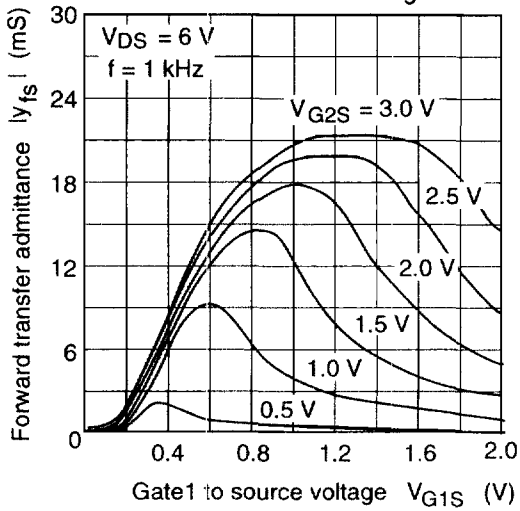

Power Gain vs. Drain Current

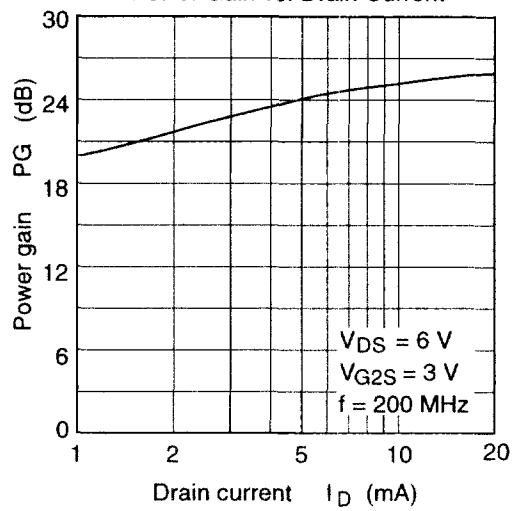

Noise Figure vs. Drain Current

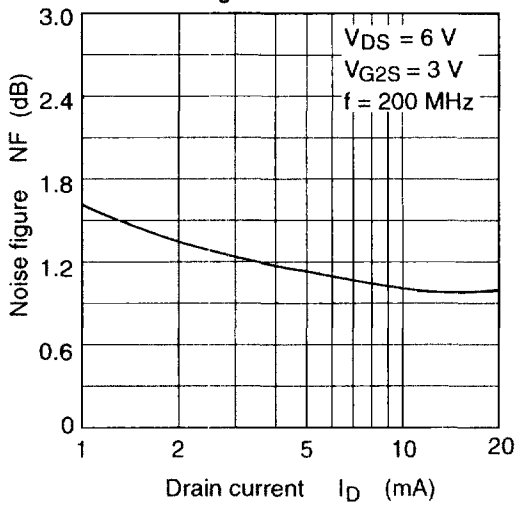

Power Gain vs. Drain to Source Voltage

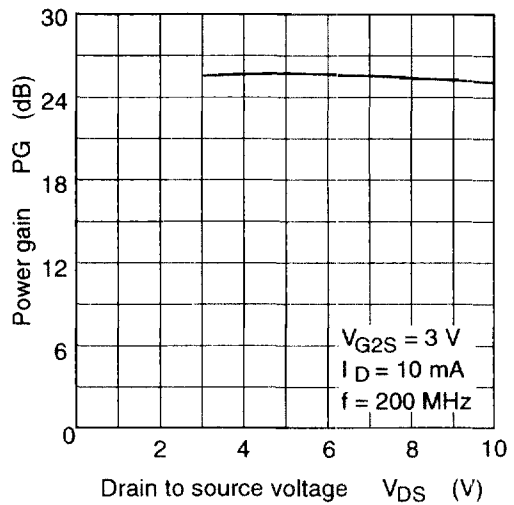

Noise Figure vs. Drain to Source Voltage

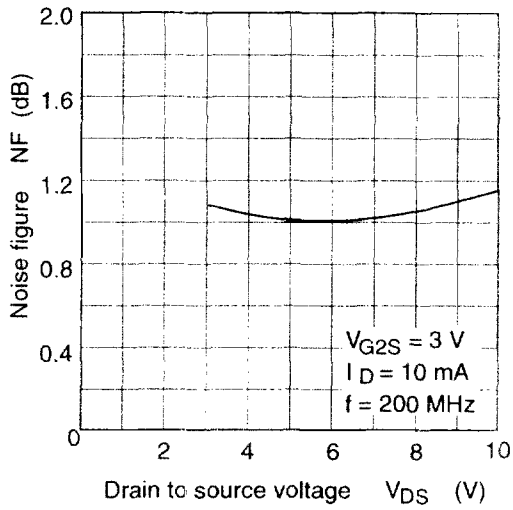

Power Gain vs. Drain Current

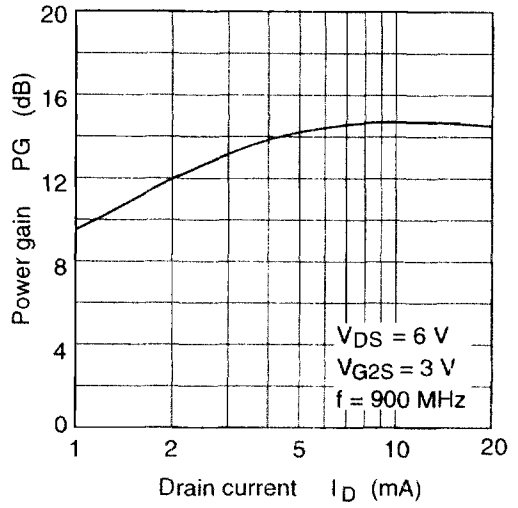

Noise Figure vs. Drain Current

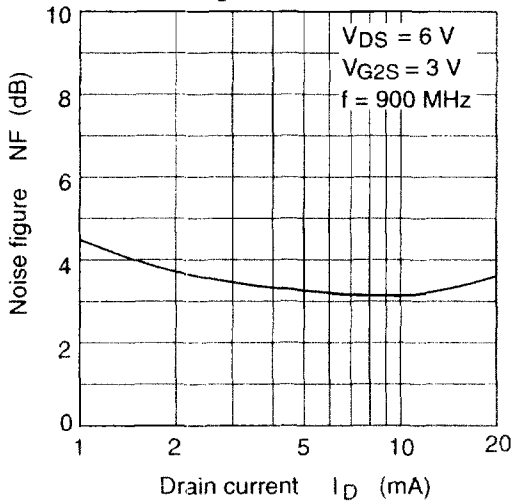

Power Gain vs. Drain to Source Voltage

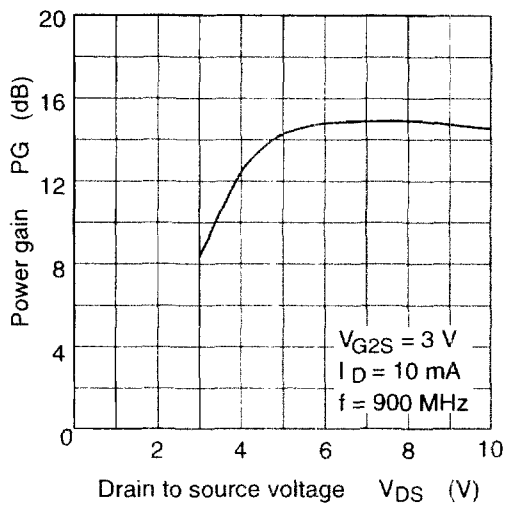

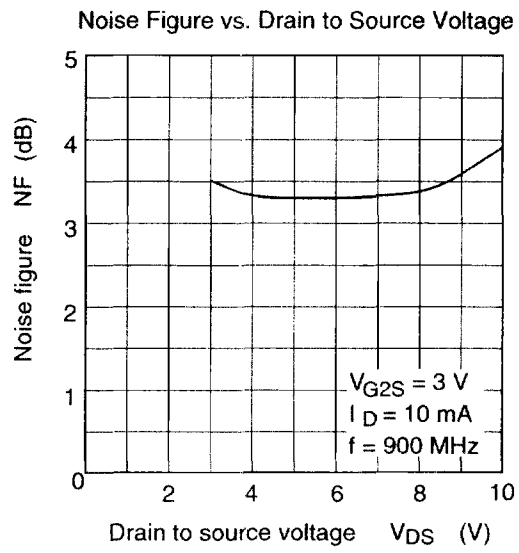

S11 Parameter vs. Frequency

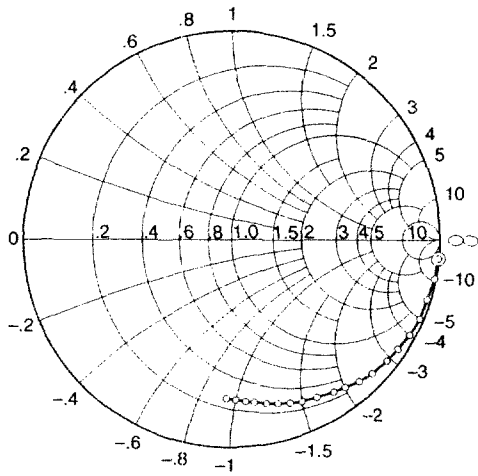

Condition: $V_{DS} = 6\text{ V}$, $V_{G2S} = 3\text{ V}$
 $I_D = 10\text{ mA}$, $Z_o = 50\ \Omega$
 50 to 1000 MHz (50 MHz step)



S21 Parameter vs. Frequency

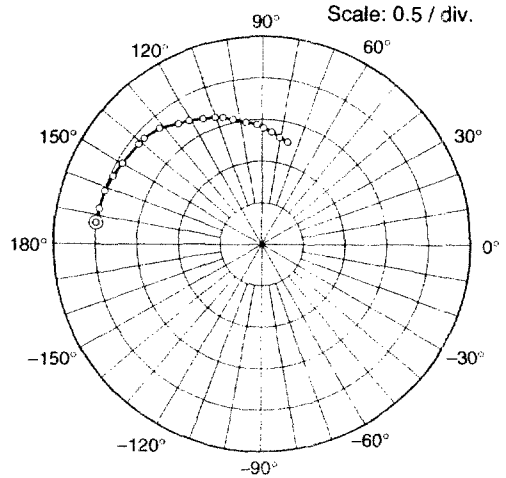

Condition: $V_{DS} = 6\text{ V}$, $V_{G2S} = 3\text{ V}$
 $I_D = 10\text{ mA}$, $Z_o = 50\ \Omega$
 50 to 1000 MHz (50 MHz step)



S12 Parameter vs. Frequency

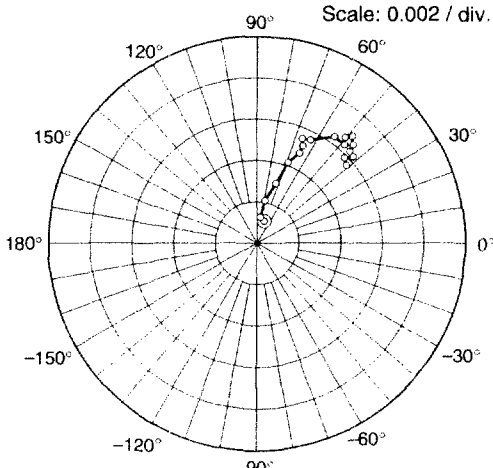

Condition: $V_{DS} = 6\text{ V}$, $V_{G2S} = 3\text{ V}$
 $I_D = 10\text{ mA}$, $Z_o = 50\ \Omega$
 50 to 1000 MHz (50 MHz step)



S22 Parameter vs. Frequency

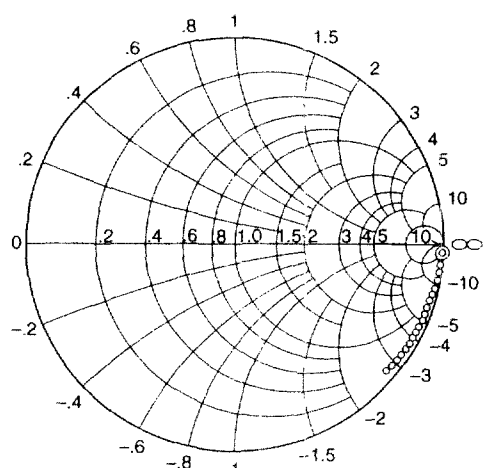

Condition: $V_{DS} = 6\text{ V}$, $V_{G2S} = 3\text{ V}$
 $I_D = 10\text{ mA}$, $Z_o = 50\ \Omega$
 50 to 1000 MHz (50 MHz step)



S Parameter ($V_{DS} = 6\text{ V}$, $V_{GS} = 3\text{ V}$, $I_D = 10\text{ mA}$, $Z_O = 50\ \Omega$)

Freq. (MHz)	S11		S21		S12		S22	
	MAG.	ANG.	MAG.	ANG.	MAG.	ANG.	MAG.	ANG.
50	0.994	-5.8	2.04	173.6	0.00116	76.9	0.993	-2.2
100	0.993	-11.0	2.02	167.4	0.00132	85.7	0.993	-4.5
150	0.986	-16.8	2.00	161.5	0.00229	78.2	0.991	-6.4
200	0.980	-22.5	1.98	155.5	0.00313	73.5	0.990	-8.5
250	0.973	-27.8	1.94	149.6	0.00427	68.7	0.987	-10.5
300	0.950	-33.0	1.90	142.6	0.00473	63.9	0.985	-12.5
350	0.936	-38.3	1.86	137.1	0.00536	64.3	0.982	-14.4
400	0.924	-43.4	1.83	131.6	0.00561	64.5	0.979	-16.2
450	0.912	-48.0	1.77	126.8	0.00562	60.9	0.975	-18.2
500	0.893	-52.5	1.71	121.0	0.00640	53.5	0.971	-20.2
550	0.874	-57.3	1.67	115.5	0.00638	49.3	0.967	-22.0
600	0.859	-62.0	1.64	111.1	0.00647	49.0	0.964	-23.9
650	0.846	-66.1	1.58	106.7	0.00667	50.2	0.960	-25.8
700	0.829	-69.8	1.50	102.1	0.00694	49.3	0.955	-27.6
750	0.810	-74.2	1.46	97.1	0.00661	46.6	0.952	-29.4
800	0.802	-78.0	1.44	92.7	0.00618	43.7	0.948	-31.2
850	0.791	-81.6	1.38	88.9	0.00622	44.7	0.944	-33.2
900	0.778	-84.6	1.34	84.2	0.00615	43.6	0.940	-35.1
950	0.756	-88.5	1.30	80.2	0.00576	45.1	0.935	-36.8
1000	0.751	-92.2	1.26	75.9	0.00562	40.7	0.932	-38.5