

DATA LDT, LDS SWITCHES – MOMENTARY (LDT) AND LATCHING (LDS) ACTION

BENEFITS

- Absolute reliability and simple assembly
- Compact design with very small mounting depth
- Excellent price/performance ratio
- Suitable for front and print-mounting
- Good illumination
- Many different application fields

		LDT	LDS
Electrical data			
Switching voltage	[mV] [V]	min. 100 AC / DC max. 60 AC / 50 DC	min. 100 AC / DC max. 60 AC / 50 DC
Switching current max.	[mA]	200	200
Lifetime (at rated breaking capacity 1.2W)		> 10 ⁵	> 10 ⁵
Initial contact resistance, new	[mΩ]	< 20	< 20
Initial contact resistance, after lifetime	[mΩ]	< 25	< 25
Insulation resistance	[Ω]	> 10 ¹⁰	> 10 ¹⁰
Contact bounce time	[ms]	typ. 0.5	typ. 0.5
Mechanical data			
Actuating force	[N]	1.2 ± 0.6	
Contact travel	[mm]	1.3 ± 0.5	
End contact travel	[mm]	2.9 ± 0.5	
End stop strength	[N]	> 50	> 50
Lifetime	[operations]	> 10 ⁵	> 10 ⁵
Other data			
Soldering method	Hand soldering(soldering terminal) or soldering bath(print terminals)		
Soldering heat resistance	[°C/s]	* 280/3(soldering) 270/5(print terminals)	* 280/3(soldering) 270/5(print terminals)
Ambient temperature	illuminated [°C/s]	-25 – + 60	-25 – + 60
	non-illuminated [°C/s]	-25 – + 85	-25 – + 85
Storage temperature	illuminated [°C/s]	-25 – + 60	-25 – + 60
	non-illuminated [°C/s]	-25 – + 85	-25 – + 85
Degree of protection		IP 40	IP 40
Materials			
Socket		Thermoplast PES	Thermoplast PES
Button		Thermoplast PC	Thermoplast PC
Contacts	gold on request	CuZn 28 with 5 μm Ag	CuZn 28 with 5 μm Ag
Contact spring		CuBe with 5 μm Ag	CuBe with 5 μm Ag
Terminals		CuZn 28 hot-dip tinned 13 ± 5 μm Sn	CuZn 28 hot-dip tinned 13 ± 5 μm Sn

LED see page 29

* Data refers to hand soldering only, not to be used for wave soldering

DIMENSIONS LDT, LDS SWITCHES – MOMENTARY AND LATCHING ACTION

CONSTRUCTION

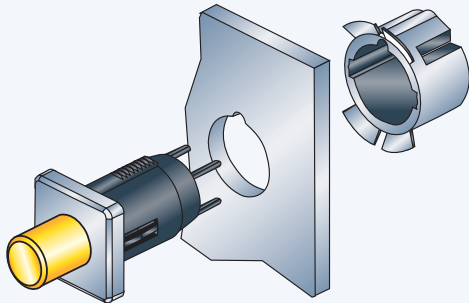

LDT / LDS, small button

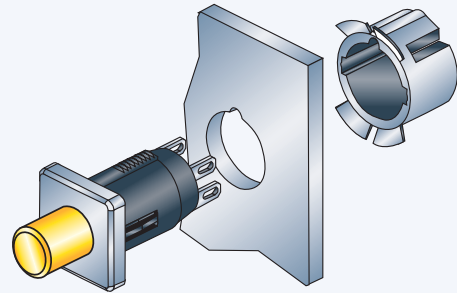

LDT / LDS, small button with solder terminal

DIMENSIONS

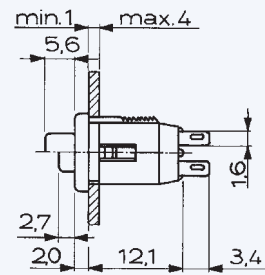
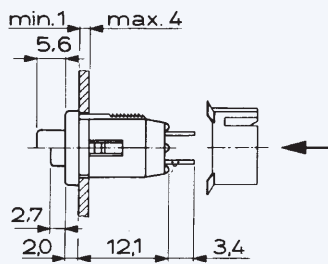

OTHER DATA

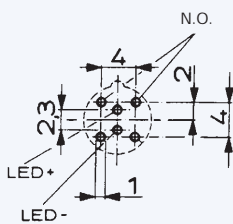

Wiring diagram

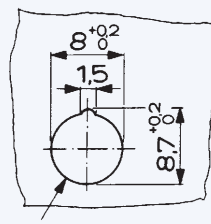

inside bevel
< 0.2 x 45°

Front panel drilling

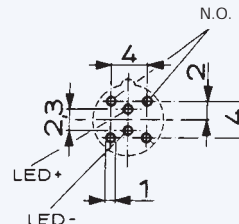

Drilling diagram

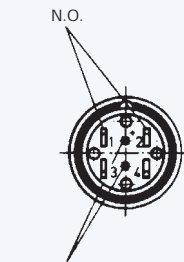

LED-terminals

Solder terminal version

CIRCUIT DIAGRAM



NO 1 pole

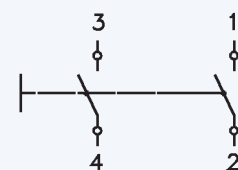

NO 2 pole

OVERVIEW LDT, LDS SWITCHES – MOMENTARY (LDT) AND LATCHING (LDS) ACTION



In addition to the versions with the small button, further versions with a large button and switching functions are available on request.

FEATURES

illumination	non-illuminated				illuminated					
Models	small button				small button					
PART NUMBER *										
LDT NO 1 pole	0041.9141.	x	x	0	x	0041.9146.	x	x	x	x
LDT NO 2 pole	0041.9142.	x	x	0	x	0041.9147.	x	x	x	x
LDS NO 1 pole	0041.9151.	x	x	0	x	0041.9156.	x	x	x	x
LDS NO 2 pole	0041.9152.	x	x	0	x	0041.9157.	x	x	x	x
Colour of small button **										
red		3				3				
green		5				5				
black		7								
Shape of bezel/button										
round			1				1			
square			3				3			
Colour of LED										
red									1	
green									2	
Colour of bezel										
black				7						7
Mounting accessories										

Securing clip*** (necessary for front panel mounting) **0850.9242**

Securing clip:



Round bezel/button :

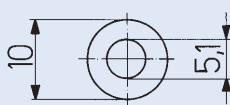

Square bezel/button :

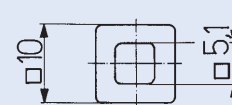

* X in the Part No. must be replaced by the desired version
 ** With the illuminated version, the small button is transparent
 ***Securing clip must be ordered separately

OVERVIEW LDT, LDS SWITCHES-MOMENTARY (LDT) AND LATCHING (LDS) ACTION



In addition to the versions with the small button, further versions with a large button and switching functions are available on request.

LDT/LDS

LDT/LDS

FEATURES

illumination	non-illuminated				illuminated					
Models	small button with solder terminal				small button with solder terminal					
PART NUMBER *										
LDT NO 1 pole	0041.8841.	x	x	0	x	0041.8846.	x	x	x	x
LDT NO 2 pole	0041.8842.	x	x	0	x	0041.8847.	x	x	x	x
LDS NO 1 pole	0041.8851.	x	x	0	x	0041.8856.	x	x	x	x
LDS NO 2 pole	0041.8852.	x	x	0	x	0041.8857.	x	x	x	x
Colour of small button **										
red		3					3			
green		5					5			
black		7								
Shape of bezel/button										
round			1					1		
square			3					3		
Colour of LED										
red									1	
green									2	
Colour of bezel										
black				7						7
Mounting accessories										
Securing clip***	0850.9242									

Securing clip:



Round bezel/ button:

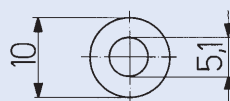

square bezel/ button:

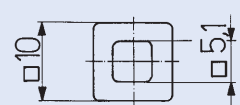

FRONTPANEL
MEDIUM STROKE

* X in the Part No. must be replaced by the desired version
 ** With the illuminated version, the small button is transparent
 ***Securing clip is included



LETTERING

Depending on the application and font, there are various lettering possibilities. The following standards can be used for key letterings:

ORDER INDEX LETTERING

A = 001	P = 016	4 = 031	↕ = 046	EIN = 061
B = 002	Q = 017	5 = 032	→ = 047	AUS = 062
C = 003	R = 018	6 = 033	← = 048	AUF = 063
D = 004	S = 019	7 = 034	↓ = 049	AB = 064
E = 005	T = 020	8 = 035	↑ = 050	ON = 065
F = 006	U = 021	9 = 036	% = 051	OFF = 066
G = 007	V = 022	+ = 037	√ = 052	UP = 067
H = 008	W = 023	- = 038	CTRL = 053	DOWN = 068
I = 009	X = 024	· = 039	RETURN = 054	HIGH = 069
J = 010	Y = 025	x = 040	SHIFT = 055	LOW = 070
K = 011	Z = 026	÷ = 041	LOCK = 056	ON/OFF = 071
L = 012	0 = 027	* = 042	STOP = 057	START = 072
M = 013	1 = 028	≡ = 043	ENTER = 058	
N = 014	2 = 029	# = 044	BACK = 059	
O = 015	3 = 030	↔ = 045	LINE = 060	

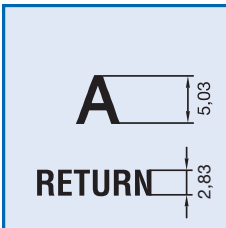

MCS 18, LETTER HEIGHTS AND FONTS

- Single characters, Univers 65
- Legends max. 6 characters in line, Univers 65
- Insert label and front foil anthracite, RAL 7016
- Characters and symbols light grey, RAL 7035

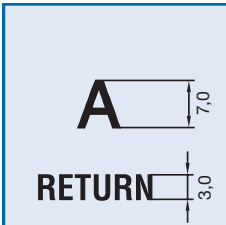

SSM 27, LETTER HEIGHTS AND FONTS

- Single characters, Univers 65
- Legends max. 6 characters in line, Akzident-Grotesk condensed bold type
- Front foil anthracite, RAL 7016
- Characters and symbols light grey, RAL 7035



LIGHTING TECHNOLOGY

TECHNICAL DATA LEDs

1. Maximum ratings				
Part number		0925.9730	0925.9731	0925.9732
Light colour		red	green	yellow
Forward current, DC	I_f max. [mA]	40	40	40
Power dissipation	P_{tot} max. [mW]	130	130	130
2. Characteristics (typ. at $T_U = 25\text{ °C}$)				
Forward voltage	at $I_f = 10\text{ mA}$, U_f typ. [mV]	2.0 (< 2.6)	2.0 (< 2.6)	2.0 (< 2.6)
Luminous intensity	at $I_f = 10\text{ mA}$, I_v typ. [mcd]	11.2 - 28	18 - 45	11.2 - 28
Viewing angle	θ typ. [Degree]	50	50	50
Peak wave length	λ_{peak} typ. [nm]	635	565	586
Reverse voltage	U_r typ. [V]	5	5	5