



# NEC's NPN SILICON RF TWIN TRANSISTOR

## UPA861TD

### FEATURES

- **LOW VOLTAGE, LOW CURRENT OPERATION**
- **LOW CAPACITANCE FOR WIDE TUNING RANGE**
- **SMALL PACKAGE OUTLINE:**  
1.2 mm x 0.8 mm
- **LOW HEIGHT PROFILE:**  
Just 0.50 mm high
- **TWO DIFFERENT DIE TYPES:**  
Q1 - Ideal buffer amplifier transistor  
Q2 - Ideal oscillator transistor
- **IDEAL FOR >3 GHz OSCILLATORS**

### DESCRIPTION

NEC's UPA861TD contains one NE894 and one NE687 NPN high frequency silicon bipolar chip. The NE894 is an excellent oscillator chip, featuring high  $f_T$  and low current, low voltage operation. The NE687 is an excellent buffer transistor, featuring low noise and high gain. NEC's new ultra small TD package is ideal for all portable wireless applications where reducing board space is a prime consideration. Each transistor chip is independently mounted and easily configured for oscillator/ buffer amplifier and other applications.

### OUTLINE DIMENSIONS (Units in mm)

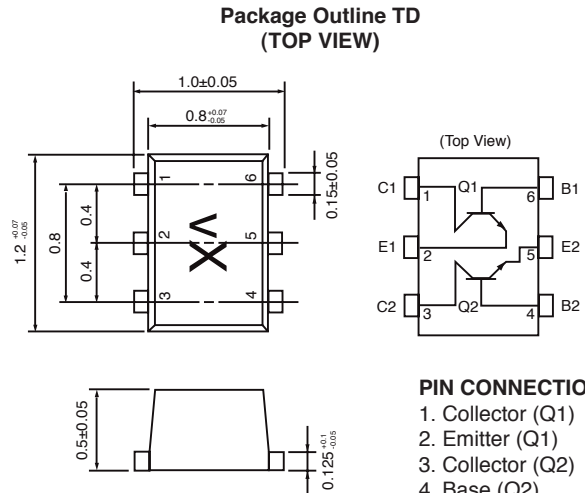

### ELECTRICAL CHARACTERISTICS (TA = 25°C)

PART NUMBER PACKAGE OUTLINE				UPA861TD TD		
	SYMBOLS	PARAMETERS AND CONDITIONS	UNITS	MIN	TYP	MAX
Q1	ICBO	Collector Cutoff Current at VCB = 5 V, IE = 0	nA			100
	IEBO	Emitter Cutoff Current at VEB = 1 V, IC = 0	nA			100
	hFE	DC Current Gain <sup>1</sup> at VCE = 1 V, IC = 10 mA		70	110	140
	fT	Gain Bandwidth at VCE = 1 V, IC = 10 mA, f = 2 GHz	GHz	10.0	12.0	
	Cre	Feedback Capacitance <sup>2</sup> at VCB = 0.5 V, IE = 0, f = 1 MHz	pF		0.4	0.8
	IS21EI <sup>2</sup>	Insertion Power Gain at VCE = 1 V, IC = 10 mA, f = 2 GHz	dB	7.0	9.0	
	NF	Noise Figure at VCE = 1 V, IC = 3 mA, f = 2 GHz	dB		1.5	2.0
Q2	ICBO	Collector Cutoff Current at VCB = 5 V, IE = 0	nA			100
	IEBO	Emitter Cutoff Current at VEB = 1 V, IC = 0	nA			100
	hFE	DC Current Gain <sup>1</sup> at VCE = 1 V, IC = 5 mA		50	75	100
	fT	Gain Bandwidth at VCE = 1 V, IC = 20 mA, f = 2 GHz	GHz	17.0	20.0	
	Cre	Feedback Capacitance <sup>2</sup> at VCB = 0.5 V, IE = 0, f = 1 MHz	pF		0.22	0.30
	IS21EI <sup>2</sup>	Insertion Power Gain at VCE = 1 V, IC = 20 mA, f = 2 GHz	dB	11.0	13.0	
	NF	Noise Figure at VCE = 1 V, IC = 5 mA, f = 2 GHz, Zs = Zopt	dB		1.4	2.5

Notes: 1. Pulsed measurement, pulse width  $\leq 350 \mu s$ , duty cycle  $\leq 2\%$ .  
2. Collector to base capacitance when measured with capacitance meter (automatic balanced bridge method), with emitter connected to guard pin of capacitances meter.

**ABSOLUTE MAXIMUM RATINGS<sup>1,2</sup>** ( $T_A = 25^\circ\text{C}$ )

SYMBOLS	PARAMETERS	UNITS	RATINGS	
			Q1	Q2
$V_{CB0}$	Collector to Base Voltage	V	5	9
$V_{CEO}$	Collector to Emitter Voltage	V	3	3
$V_{EBO}$	Emitter to Base Voltage	V	2	1.5
$I_C$	Collector Current	mA	30	35
$P_T$	Total Power Dissipation <sup>1</sup>	mW	90	105
			195 Total	
$T_J$	Junction Temperature	$^\circ\text{C}$	150	150
$T_{STG}$	Storage Temperature	$^\circ\text{C}$	-65 to +150	

Note: 1. Operation in excess of any one of these parameters may result in permanent damage.  
 2. Mounted on 1.08cm<sup>2</sup> x 1.0 mm(t) glass epoxy PCB

**ORDERING INFORMATION**

PART NUMBER	QUANTITY	PACKAGING
UPA861TD-T3-A	10K Pcs./Reel	Tape & Reel

**TYPICAL CHARACTERISTICS** ( $T_A = 25^\circ\text{C}$ , unless otherwise specified)

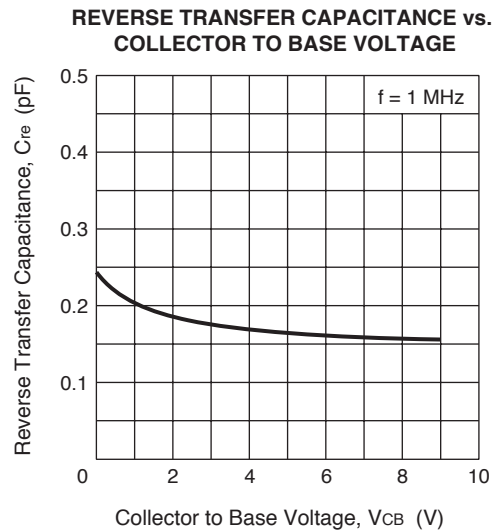
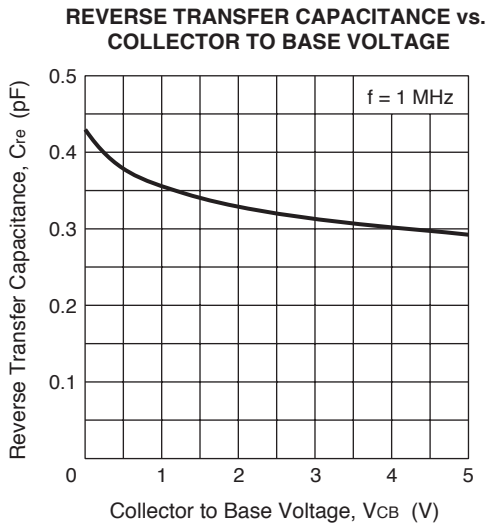
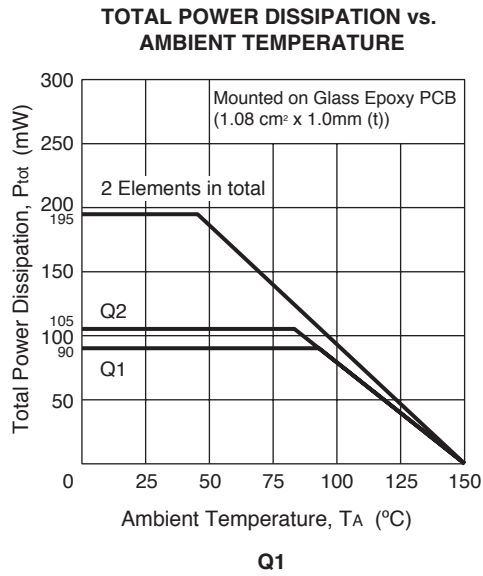

**TYPICAL CHARACTERISTICS, cont.** ( $T_A = 25^\circ\text{C}$ , unless otherwise specified)

Q1

**COLLECTOR CURRENT vs. BASE TO EMITTER VOLTAGE**

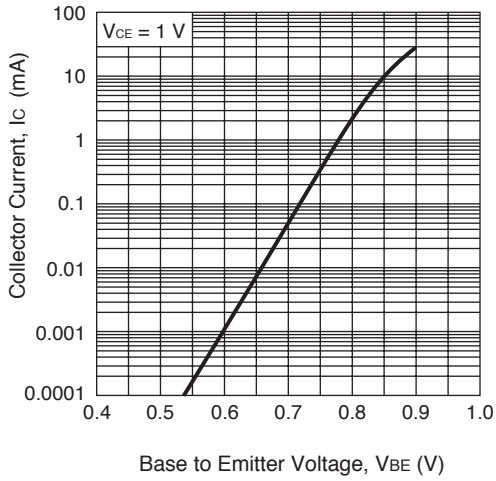

Q2

**COLLECTOR CURRENT vs. BASE TO EMITTER VOLTAGE**

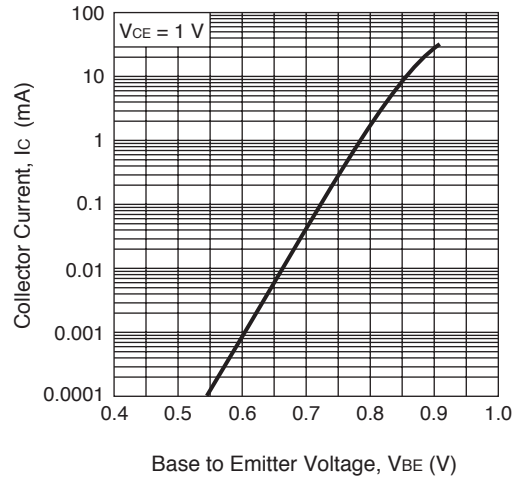

**COLLECTOR CURRENT vs. BASE TO EMITTER VOLTAGE**

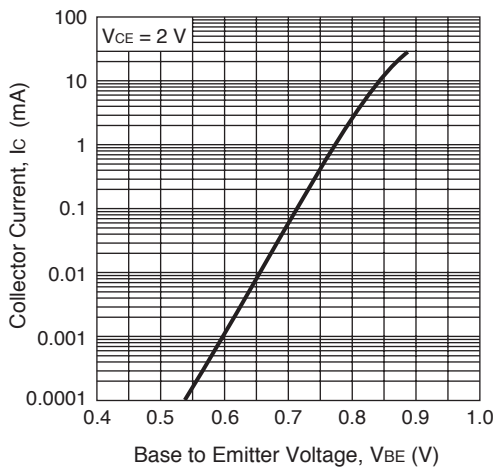

**COLLECTOR CURRENT vs. BASE TO EMITTER VOLTAGE**

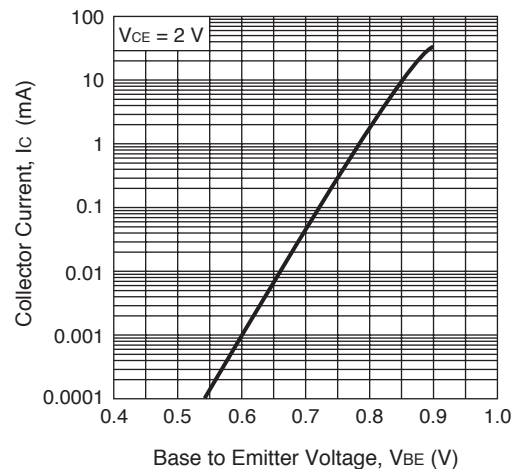

**COLLECTOR CURRENT vs. COLLECTOR TO EMITTER VOLTAGE**

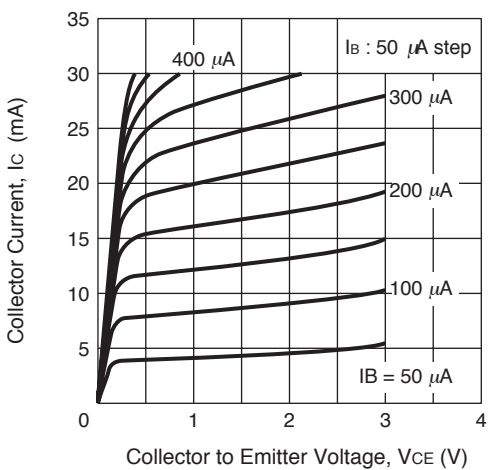

**COLLECTOR CURRENT vs. COLLECTOR TO EMITTER VOLTAGE**

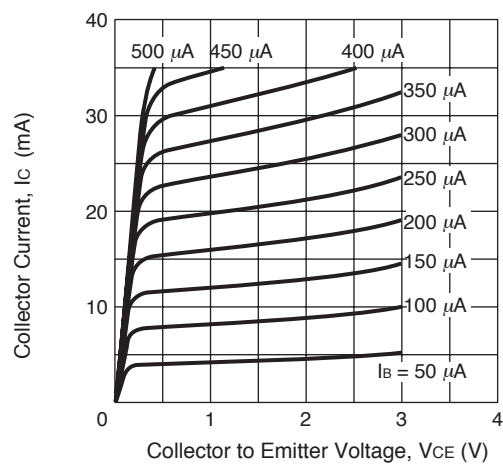

**TYPICAL CHARACTERISTICS, cont.** ( $T_A = 25^\circ\text{C}$ , unless otherwise specified)

Q1

**DC VOLTAGE vs. COLLECTOR CURRENT**

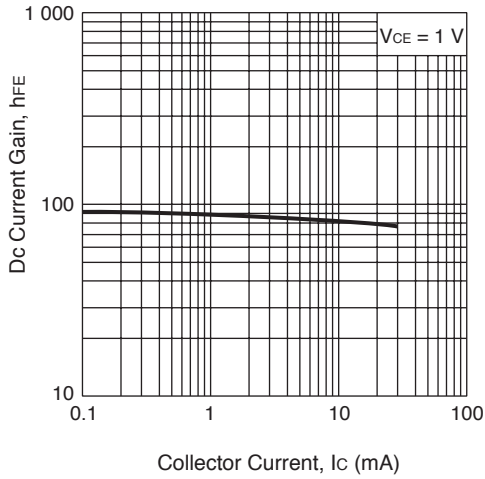

Q2

**DC VOLTAGE vs. COLLECTOR CURRENT**

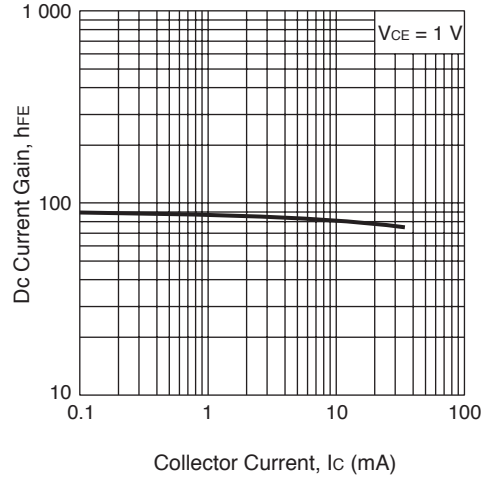

**GAIN BANDWIDTH PRODUCT vs. COLLECTOR CURRENT**

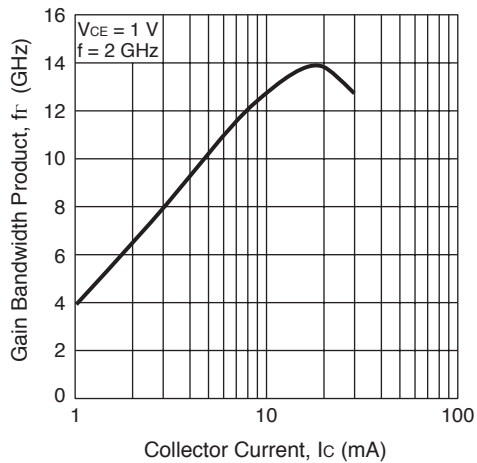

**GAIN BANDWIDTH PRODUCT vs. COLLECTOR CURRENT**

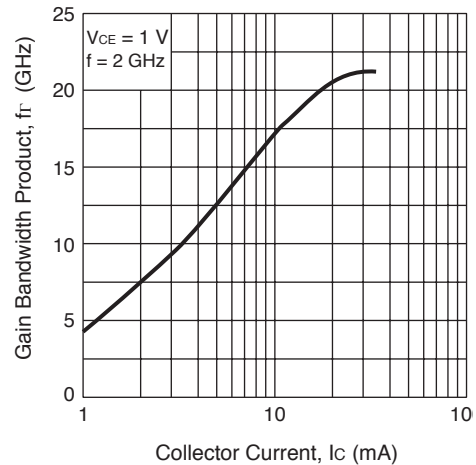

**INSERTION POWER GAIN, MAG, MSG vs. FREQUENCY**

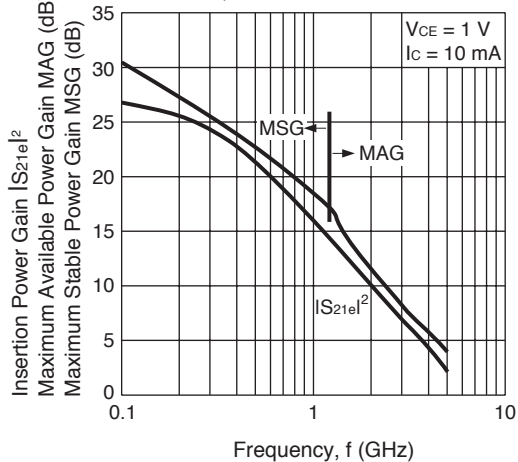

**INSERTION POWER GAIN, MAG, MSG vs. FREQUENCY**

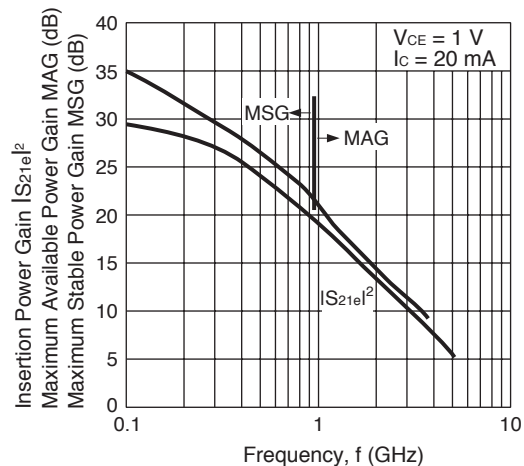

TYPICAL CHARACTERISTICS, cont. (T<sub>A</sub> = 25°C, unless otherwise specified)

Q1

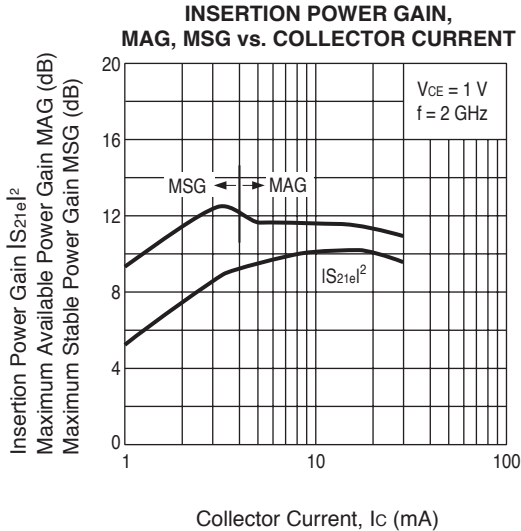

Q2

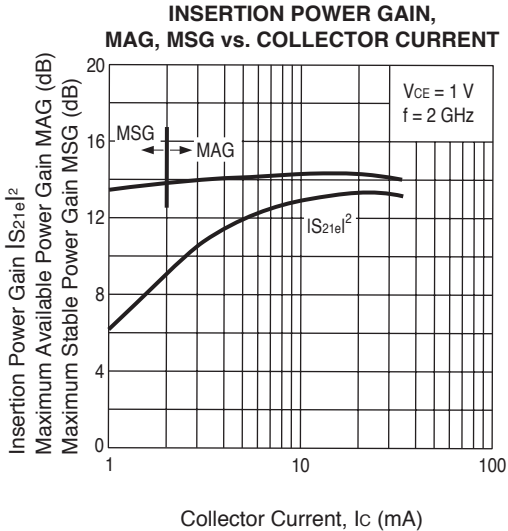

**INSERTION POWER GAIN, MAG vs. COLLECTOR CURRENT**

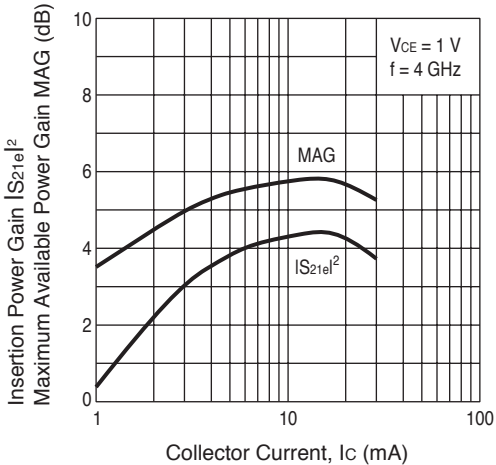

**INSERTION POWER GAIN, MAG, MSG vs. COLLECTOR CURRENT**

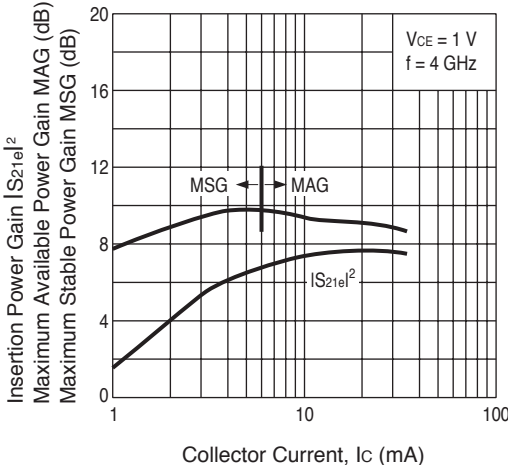

**INSERTION POWER GAIN, MAG vs. COLLECTOR CURRENT**

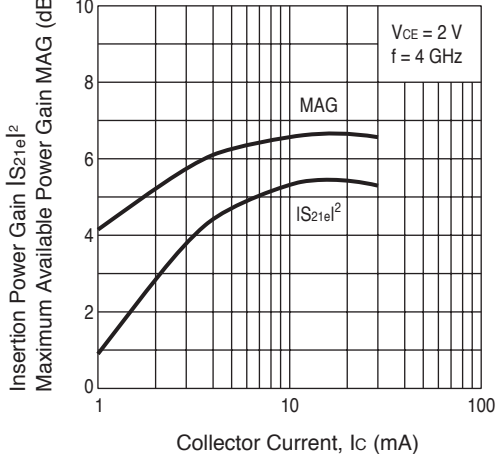

**INSERTION POWER GAIN, MAG, MSG vs. COLLECTOR CURRENT**

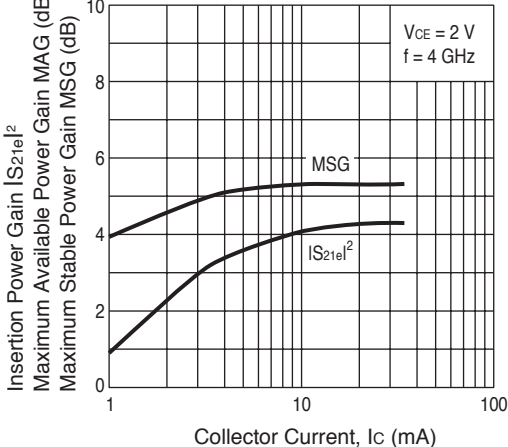

TYPICAL CHARACTERISTICS, cont. ( $T_A = 25^\circ\text{C}$ , unless otherwise specified)

Q1

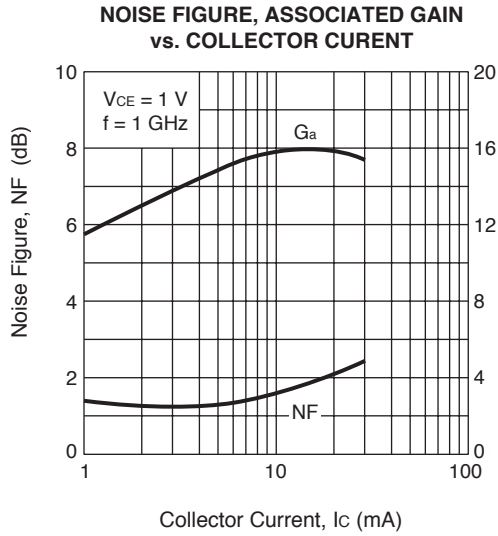

Q2

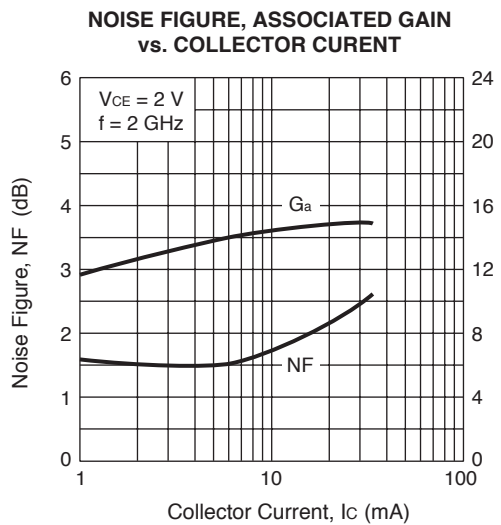
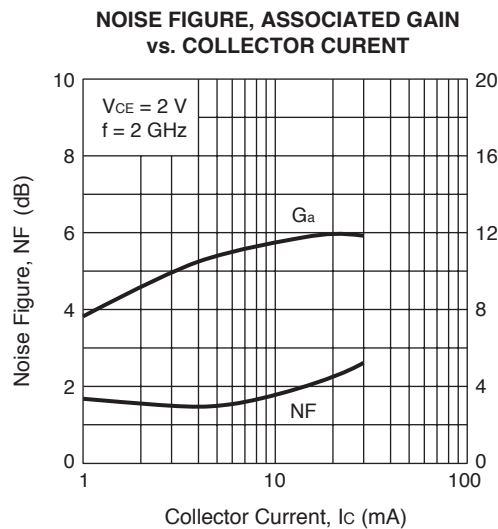
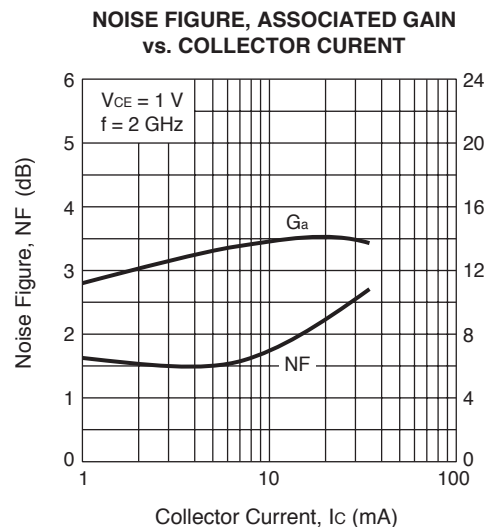
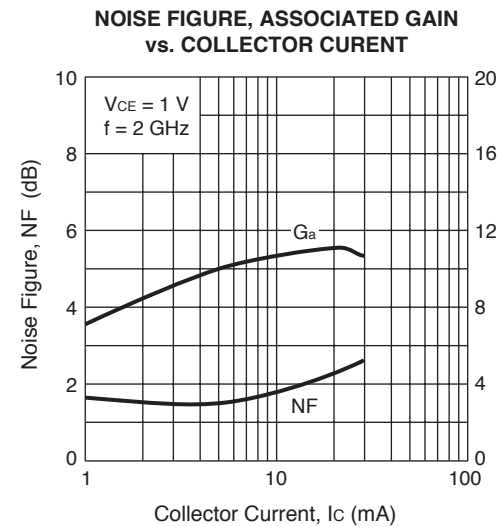
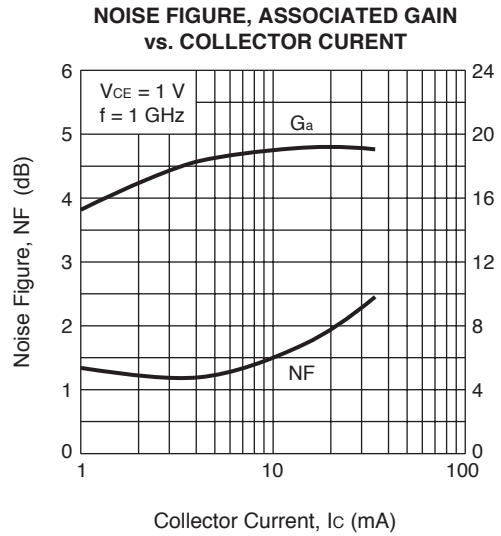

TYPICAL SCATTERING PARAMETERS

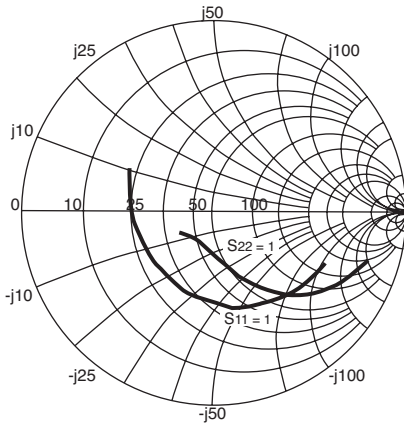

0.100 to 3.000GHz by 0.050

Coordinates in Ohms  
Frequency in GHz  
VCE = 1 V, IC = 10 mA

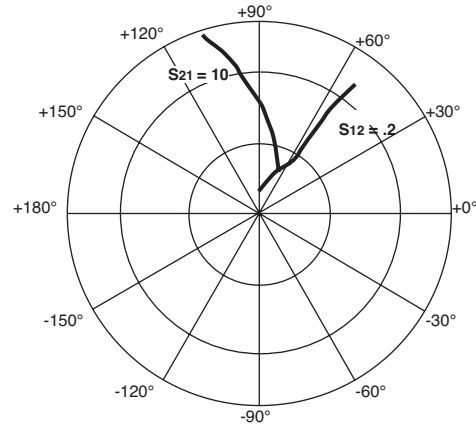

0.100 to 3.000GHz by 0.050

UPA861TD (Q1)

VCE = 1 V, IC = 10 mA

Frequency GHz	S11		S21		S12		S22		K	MAG <sup>1</sup> (dB)
	MAG	ANG	MAG	ANG	MAG	ANG	MAG	ANG		
0.10	0.691	-25.9	20.769	160.8	0.018	78.6	0.902	-18.3	0.17	30.51
0.20	0.625	-51.3	18.506	144.8	0.033	66.0	0.793	-32.9	0.28	27.44
0.30	0.559	-72.3	16.074	132.3	0.044	59.6	0.678	-44.0	0.38	25.58
0.40	0.507	-89.7	13.885	122.8	0.052	55.7	0.581	-52.3	0.47	24.25
0.50	0.470	-104.3	12.048	115.3	0.058	53.8	0.501	-58.7	0.56	23.17
0.60	0.445	-116.3	10.549	109.5	0.064	52.4	0.440	-63.8	0.63	22.20
0.70	0.426	-126.4	9.332	104.6	0.068	52.1	0.389	-68.2	0.70	21.35
0.80	0.415	-135.1	8.348	100.5	0.073	51.9	0.349	-72.0	0.76	20.58
0.90	0.408	-142.8	7.536	96.9	0.078	52.0	0.317	-75.7	0.81	19.88
1.00	0.404	-149.5	6.861	93.7	0.082	52.0	0.291	-79.2	0.85	19.22
1.10	0.402	-155.5	6.287	90.8	0.087	52.4	0.269	-82.6	0.89	18.61
1.20	0.400	-161.0	5.800	88.2	0.091	52.7	0.250	-86.1	0.92	18.03
1.30	0.401	-165.9	5.380	85.7	0.096	52.9	0.234	-89.6	0.95	17.49
1.40	0.403	-170.4	5.014	83.4	0.100	53.1	0.222	-93.1	0.97	16.99
1.50	0.406	-174.4	4.693	81.2	0.105	53.1	0.212	-96.9	1.00	16.50
1.60	0.410	-178.1	4.409	79.2	0.110	53.3	0.204	-100.5	1.01	15.32
1.70	0.414	178.5	4.155	77.3	0.114	53.4	0.198	-104.0	1.03	14.53
1.80	0.419	175.3	3.930	75.4	0.119	53.4	0.193	-107.7	1.05	13.89
1.90	0.424	172.5	3.729	73.6	0.123	53.4	0.190	-111.4	1.06	13.35
2.00	0.428	169.9	3.543	71.9	0.128	53.2	0.188	-114.7	1.07	12.83
2.10	0.434	167.5	3.376	70.2	0.133	53.2	0.188	-118.1	1.08	12.37
2.20	0.438	165.3	3.223	68.6	0.137	53.0	0.188	-121.1	1.08	11.93
2.30	0.443	163.2	3.086	67.1	0.142	53.0	0.189	-124.1	1.09	11.53
2.40	0.447	161.3	2.959	65.7	0.146	52.8	0.190	-126.8	1.10	11.15
2.50	0.452	159.5	2.842	64.2	0.151	52.6	0.192	-129.2	1.10	10.80
2.60	0.456	158.0	2.734	62.8	0.155	52.3	0.193	-131.1	1.11	10.46
2.70	0.461	156.5	2.634	61.5	0.160	52.2	0.195	-132.9	1.11	10.15
2.80	0.464	155.3	2.544	60.1	0.164	51.9	0.198	-134.4	1.11	9.85
2.90	0.467	154.1	2.459	58.8	0.169	51.8	0.200	-136.1	1.12	9.56
3.00	0.470	153.0	2.381	57.6	0.173	51.4	0.202	-137.1	1.12	9.30

Note:

1. Gain Calculations:

$$MAG = \frac{|S_{21}|}{|S_{12}|} (K \pm \sqrt{K^2 - 1})$$

When  $K \leq 1$ , MAG is undefined and MSG values are used.  $MSG = \frac{|S_{21}|}{|S_{12}|}$ ,  $K = \frac{1 + |\Delta|^2 - |S_{11}|^2 - |S_{22}|^2}{2 |S_{12} S_{21}|}$ ,  $\Delta = S_{11} S_{22} - S_{21} S_{12}$

MAG = Maximum Available Gain

MSG = Maximum Stable Gain

TYPICAL SCATTERING PARAMETERS

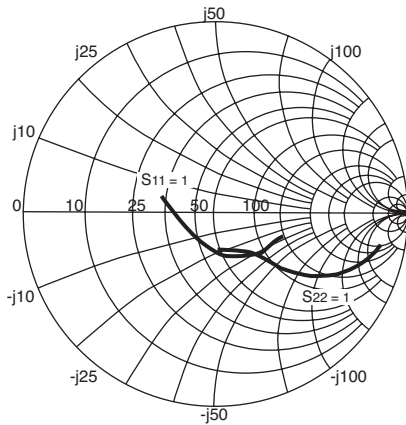

0.100 to 3.000GHz by 0.050

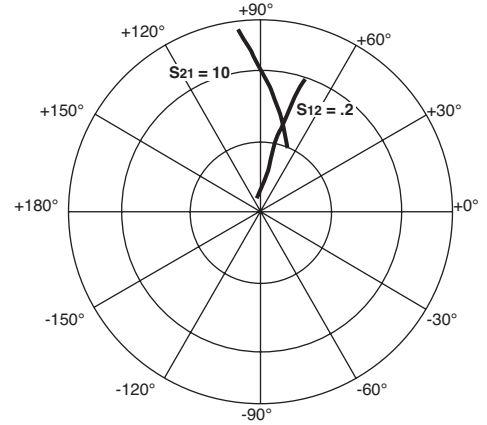

0.100 to 3.000GHz by 0.050

Coordinates in Ohms  
Frequency in GHz  
V<sub>CE</sub> = 1 V, I<sub>c</sub> = 20 mA

UPA861TD (Q2)

V<sub>CE</sub> = 1 V, I<sub>c</sub> = 20 mA

Frequency GHz	S <sub>11</sub>		S <sub>21</sub>		S <sub>12</sub>		S <sub>22</sub>		K	MAG <sup>1</sup> (dB)
	MAG	ANG	MAG	ANG	MAG	ANG	MAG	ANG		
0.10	0.401	-21.6	29.200	161.7	0.008	83.0	0.891	-12.9	0.43	35.60
0.20	0.358	-40.9	25.940	145.9	0.015	74.6	0.805	-23.2	0.51	32.24
0.30	0.308	-56.8	22.512	133.8	0.022	72.4	0.710	-30.3	0.62	30.19
0.40	0.265	-70.1	19.468	124.6	0.027	72.0	0.629	-35.1	0.71	28.66
0.50	0.231	-81.9	16.923	117.4	0.031	72.1	0.563	-38.1	0.79	27.35
0.60	0.206	-92.6	14.860	111.7	0.036	71.6	0.512	-40.2	0.86	26.20
0.70	0.187	-102.5	13.191	107.0	0.040	72.0	0.471	-41.6	0.90	25.15
0.80	0.174	-111.7	11.835	103.0	0.045	72.0	0.439	-42.7	0.94	24.22
0.90	0.164	-120.4	10.710	99.5	0.049	72.3	0.413	-43.7	0.97	23.37
1.00	0.159	-128.6	9.775	96.4	0.054	72.5	0.391	-44.7	0.99	22.58
1.10	0.156	-136.3	8.985	93.6	0.059	72.7	0.372	-45.5	1.00	21.43
1.20	0.154	-143.5	8.311	91.0	0.063	72.8	0.355	-46.6	1.02	20.30
1.30	0.154	-150.2	7.727	88.7	0.068	72.9	0.341	-47.6	1.03	19.45
1.40	0.157	-156.0	7.219	86.4	0.072	72.9	0.328	-48.7	1.04	18.73
1.50	0.160	-161.2	6.772	84.3	0.077	72.8	0.316	-50.1	1.05	18.06
1.60	0.165	-165.9	6.381	82.4	0.082	72.7	0.306	-51.4	1.05	17.48
1.70	0.170	-170.1	6.030	80.5	0.087	72.5	0.297	-52.9	1.06	16.93
1.80	0.177	-174.0	5.716	78.6	0.092	72.3	0.288	-54.6	1.06	16.43
1.90	0.183	-176.9	5.437	76.8	0.096	72.0	0.280	-56.4	1.07	15.96
2.00	0.190	-179.8	5.180	75.2	0.101	71.8	0.273	-58.3	1.07	15.52
2.10	0.197	177.6	4.949	73.5	0.106	71.6	0.266	-60.4	1.07	15.11
2.20	0.204	175.8	4.736	71.8	0.111	71.3	0.261	-62.5	1.07	14.73
2.30	0.211	173.4	4.543	70.3	0.116	71.1	0.255	-64.8	1.07	14.35
2.40	0.218	171.9	4.366	68.8	0.121	70.8	0.250	-67.0	1.07	14.01
2.50	0.224	170.2	4.200	67.2	0.126	70.4	0.245	-69.4	1.07	13.68
2.60	0.231	169.0	4.047	65.8	0.130	70.0	0.242	-71.7	1.06	13.37
2.70	0.237	167.8	3.906	64.3	0.135	69.6	0.238	-74.1	1.06	13.07
2.80	0.243	166.9	3.776	62.9	0.141	69.4	0.237	-76.5	1.06	12.81
2.90	0.249	165.9	3.654	61.5	0.146	68.9	0.234	-79.1	1.06	12.53
3.00	0.254	165.3	3.542	60.1	0.151	68.5	0.235	-81.3	1.05	12.31



**NON-LINEAR MODEL****BJT NONLINEAR MODEL PARAMETERS(1)**

Parameters	Q1	Q2	Parameters	Q1	Q2
IS	8e-17	137e-18	MJC	0.53	0.24
BF	128	129	XCJC	1	0.3
NF	1	0.9992	CJS	0	0
VAF	17	22.4	VJS	0.75	0.75
IKF	0.18	2.8	MJS	0	0
ISE	3.3e-15	229e-15	FC	0.37	0.55
NE	1.48	2.5	TF	6e-12	5e-12
BR	9.05	81.7	XTF	11.9	0.05
NR	1.05	0.9944	VTF	9.55	0.5
VAR	4.3	1.9	ITF	1.78	0.005
IKR	0.009	0.018	PTF	69.1	0
ISC	4e-15	227e-18	TR	1e-9	1.0e-9
NC	2	1.17	EG	1.11	1.11
RE	0.8	0.75	XTB	0	0
RB	11.1	5	XTI	3	3
RBM	2.46	3	KF	0	117e-15
IRB	0.02	0.005	AF	1	1.34
RC	7.5	6			
CJE	0.415e-12	0.68e-12			
VJE	0.68	0.92			
MJE	0.53	0.26			
CJC	0.102e-12	0.16e-12			
VJC	0.29	0.64			

(1) Gummel-Poon Model

**MODEL RANGE**

Frequency: 0.1 to 3.0 GHz

Bias:  $V_{CE} = 0.5 \text{ V}$  to  $2.5 \text{ V}$ ,  $I_c = 0.5 \text{ mA}$  to  $20 \text{ mA}$ 

Date: 09/02

SCHEMATIC

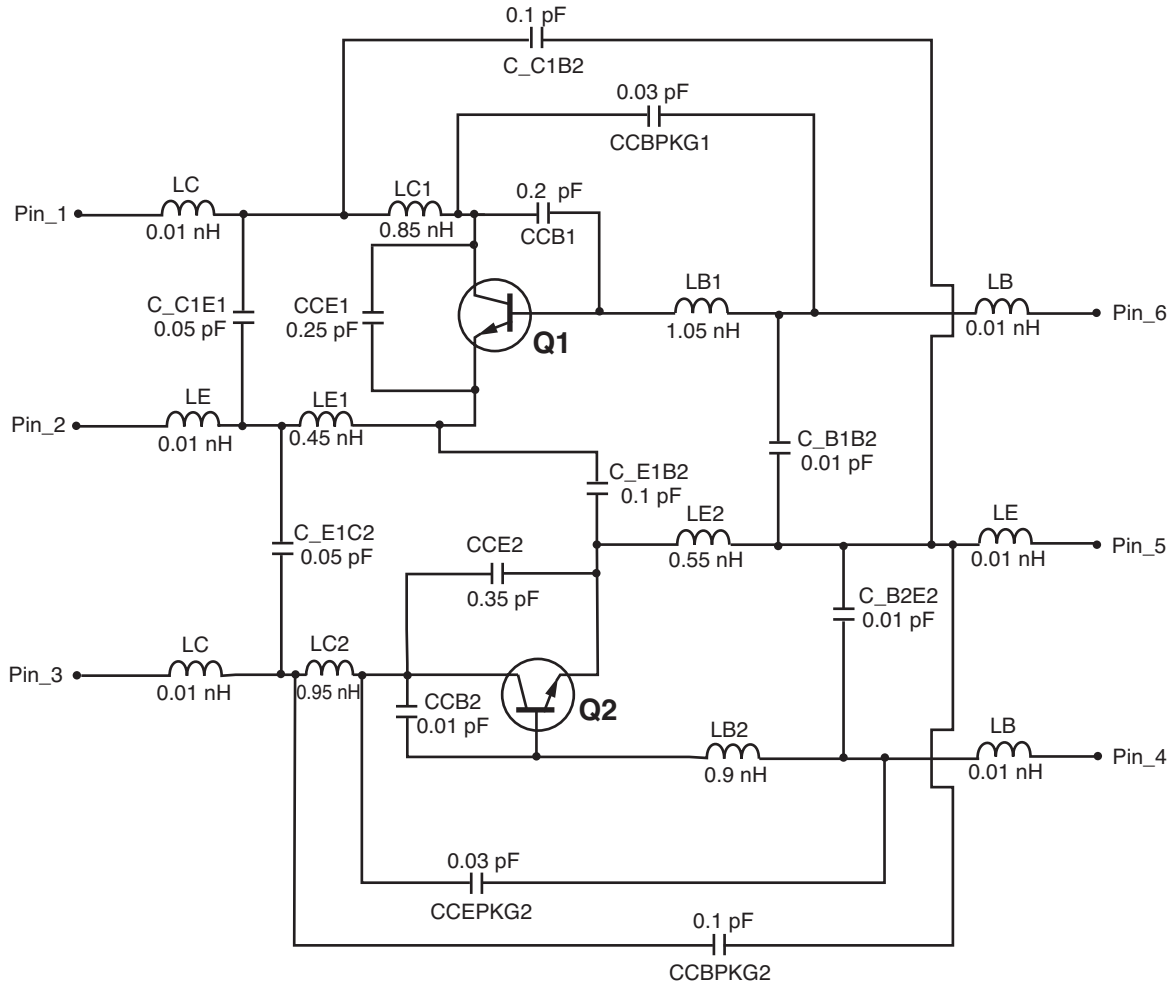

MODEL RANGE

Frequency: 0.1 to 3.0 GHz  
 Bias:  $V_{CE} = 0.5 \text{ V to } 2.5 \text{ V}$ ,  $I_c = 0.5 \text{ mA to } 20 \text{ mA}$   
 Date: 09/02

Life Support Applications

These NEC products are not intended for use in life support devices, appliances, or systems where the malfunction of these products can reasonably be expected to result in personal injury. The customers of CEL using or selling these products for use in such applications do so at their own risk and agree to fully indemnify CEL for all damages resulting from such improper use or sale.

**CEL** California Eastern Laboratories, Your source for NEC RF, Microwave, Optoelectronic, and Fiber Optic Semiconductor Devices.  
 4590 Patrick Henry Drive • Santa Clara, CA 95054-1817 • (408) 988-3500 • FAX (408) 988-0279 • [www.cel.com](http://www.cel.com)

DATA SUBJECT TO CHANGE WITHOUT NOTICE

09/17/2002

Subject: Compliance with EU Directives

CEL certifies, to its knowledge, that semiconductor and laser products detailed below are compliant with the requirements of European Union (EU) Directive 2002/95/EC Restriction on Use of Hazardous Substances in electrical and electronic equipment (RoHS) and the requirements of EU Directive 2003/11/EC Restriction on Penta and Octa BDE.

CEL Pb-free products have the same base part number with a suffix added. The suffix –A indicates that the device is Pb-free. The –AZ suffix is used to designate devices containing Pb which are exempted from the requirement of RoHS directive (\*). In all cases the devices have Pb-free terminals. All devices with these suffixes meet the requirements of the RoHS directive.

This status is based on CEL’s understanding of the EU Directives and knowledge of the materials that go into its products as of the date of disclosure of this information.

Restricted Substance per RoHS	Concentration Limit per RoHS (values are not yet fixed)	Concentration contained in CEL devices	
		-A	-AZ
Lead (Pb)	< 1000 PPM	Not Detected	(*)
Mercury	< 1000 PPM	Not Detected	
Cadmium	< 100 PPM	Not Detected	
Hexavalent Chromium	< 1000 PPM	Not Detected	
PBB	< 1000 PPM	Not Detected	
PBDE	< 1000 PPM	Not Detected	

If you should have any additional questions regarding our devices and compliance to environmental standards, please do not hesitate to contact your local representative.

Important Information and Disclaimer: Information provided by CEL on its website or in other communications concerning the substance content of its products represents knowledge and belief as of the date that it is provided. CEL bases its knowledge and belief on information provided by third parties and makes no representation or warranty as to the accuracy of such information. Efforts are underway to better integrate information from third parties. CEL has taken and continues to take reasonable steps to provide representative and accurate information but may not have conducted destructive testing or chemical analysis on incoming materials and chemicals. CEL and CEL suppliers consider certain information to be proprietary, and thus CAS numbers and other limited information may not be available for release.

In no event shall CEL’s liability arising out of such information exceed the total purchase price of the CEL part(s) at issue sold by CEL to customer on an annual basis.

See CEL Terms and Conditions for additional clarification of warranties and liability.