

# SD3410/5410

## Silicon Photodarlington

### FEATURES

- TO-46 metal can package
- Choice of flat window or lensed package
- 90° or 12° (nominal) acceptance angle option
- Wide operating temperature range (-55°C to +125°C)
- Wide sensitivity ranges
- Mechanically and spectrally matched to SE3450/5450, SE3455/5455 and SE3470/5470 infrared emitting diodes

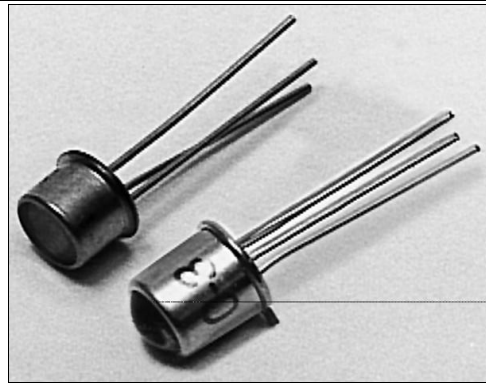

INFRA-17.TIF

### DESCRIPTION

The SD3410/5410 series consists of an NPN silicon photodarlington mounted in a TO-46 metal can package. The SD3410 has flat window cans providing a wide acceptance angle, while the SD5410 has glass lensed cans providing a narrow acceptance angle. The TO-46 packages are ideally suited for operation in hostile environments.

### OUTLINE DIMENSIONS in inches (mm)

Tolerance	3 plc decimals	±0.005(0.12)
	2 plc decimals	±0.020(0.51)

### SD3410

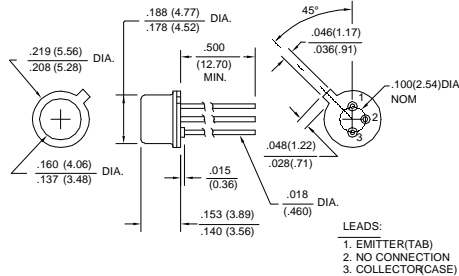

DIM\_021.ds4

### SD5410

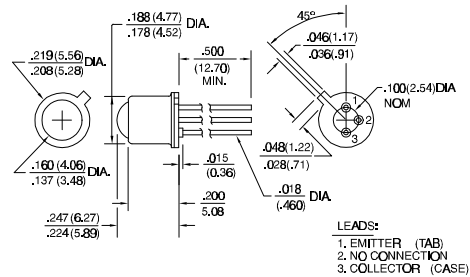

DIM\_21b.ds4

# SD3410/5410

## Silicon Photodarlington

### ELECTRICAL CHARACTERISTICS (25°C unless otherwise noted)

PARAMETER	SYMBOL	MIN	TYP	MAX	UNITS	TEST CONDITIONS
Light Current SD3410-001 SD3410-002 SD3410-003 SD3410-004	$I_L$	0.6 2.0 4.0 8.0			mA	$V_{CE}=5\text{ V}$ $H=2\text{ mW/cm}^2$ (1)
Light Current SD5410-001 SD5410-002 SD5410-003	$I_L$	2.0 4.0 8.0			mA	$V_{CE}=5\text{ V}$ $H=0.2\text{ mW/cm}^2$ (1)
Collector Dark Current	$I_{CE0}$			250	nA	$V_{CE}=10\text{ V}$ , $H=0$
Collector-Emitter Breakdown Voltage	$V_{(BR)CEO}$	15			V	$I_C=100\text{ }\mu\text{A}$
Emitter-Collector Breakdown Voltage	$V_{(BR)ECO}$	5.0			V	$I_E=100\text{ }\mu\text{A}$
Collector-Emitter Saturation Voltage SD3410 SD5410	$V_{CE(SAT)}$			1.1	V	$I_C=1\text{ mA}$ $H=2\text{ mW/cm}^2$ $H=0.2\text{ mW/cm}^2$
Angular Response (2) SD3410 SD5410	$\emptyset$		90 12		degr.	$I_F=\text{Constant}$
Rise And Fall Time	$t_r, t_f$		75		$\mu\text{s}$	$V_{CC}=5\text{ V}$ , $I_L=1\text{ mA}$ $R_L=100\text{ }\Omega$

#### Notes

- The radiation source is a tungsten lamp operating at a color temperature of 2870°K.
- Angular response is defined as the total included angle between the half sensitivity points.

### ABSOLUTE MAXIMUM RATINGS

(25°C Free-Air Temperature unless otherwise noted)

Collector-Emitter Voltage	15 V
Emitter-Collector Voltage	5 V
Power Dissipation	150 mW (1)
Operating Temperature Range	-55°C to 125°C
Storage Temperature Range	-65°C to 150°C
Soldering Temperature (10 sec)	260°C

#### Notes

- Derate linearly from 25°C free-air temperature at the rate of 1.43 mW/°C.

### SCHEMATIC

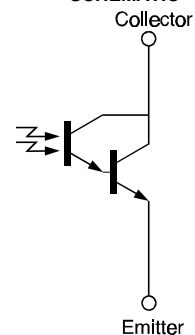

Honeywell reserves the right to make changes in order to improve design and supply the best products possible.

# Honeywell

# SD3410/5410

## Silicon Photodarlington

SWITCHING TIME TEST CIRCUIT

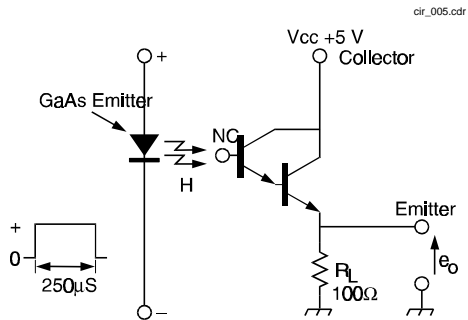

SWITCHING WAVEFORM

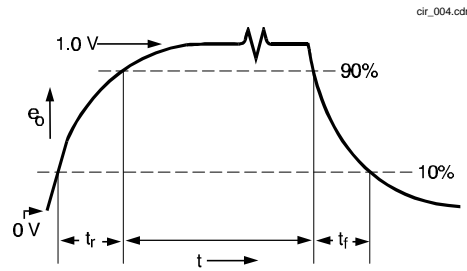

Fig. 1 Responsivity vs Angular Displacement (SD3410)

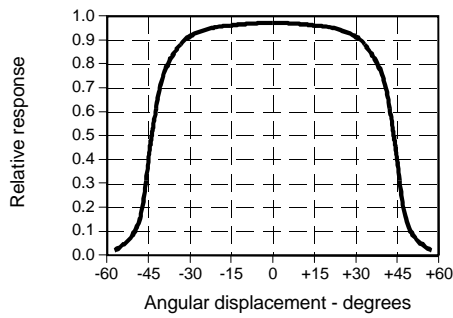

Fig. 2 Responsivity vs Angular Displacement (SD5410)

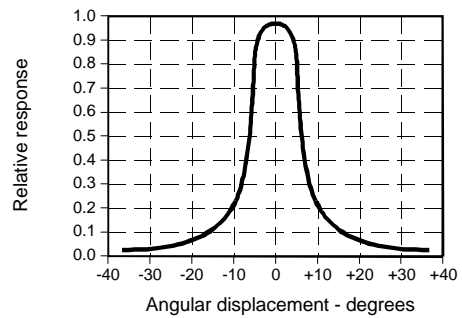

Fig. 3 Non-Saturated Switching Time vs Load Resistance

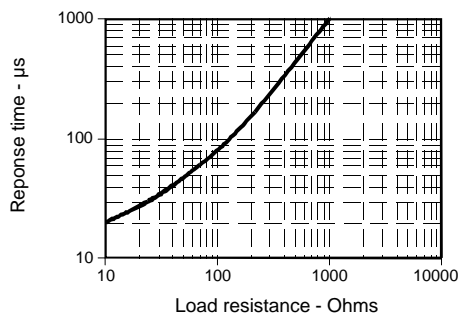
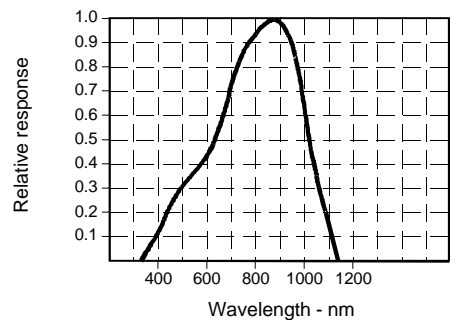

Fig. 4 Spectral Responsivity



All Performance Curves Show Typical Values

**SD3410/5410**  
Silicon Photodarlington

---



Honeywell reserves the right to make changes in order to improve design and supply the best products possible.

**Honeywell**