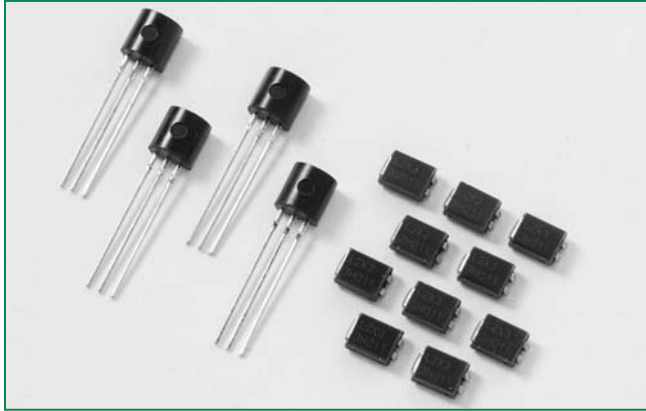

RoHS LxX8Ex & LxXx & QxX8E & QxXx Series

Description

0.8 Amp bi-directional solid state switch series is designed for AC switching and phase control applications such as motor speed and temperature modulation controls, lighting controls, and static switching relays.

Sensitive type devices guarantee gate control in Quadrants I & IV needed for digital control circuitry.

Standard type devices normally operate in Quadrants I & III triggered from AC line.

Features

- RoHS Compliant
- Glass – passivated junctions
- Voltage capability up to 600 V
- Surge capability up to 10 A

Applications

Excellent for lower current heating controls, water valves, and solenoids.

Typical applications are AC solid-state switches, home/brown goods and white goods appliances.

Sensitive gate Triacs can be directly driven by microprocessor or popular opto-couplers/isolators.

Main Features

Symbol	Value	Unit
$I_{T(RMS)}$	0.8	A
V_{DRM}/V_{RRM}	400 to 600	V
$I_{GT(Q1)}$	3 to 25	mA

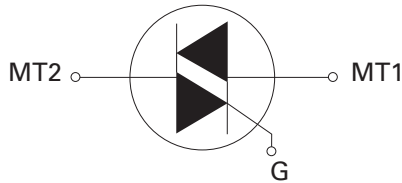
Schematic Symbol

Absolute Maximum Ratings – Sensitive Triacs (4 Quadrants)

Symbol	Parameter		Value	Unit	
$I_{T(RMS)}$	RMS on-state current (full sine wave)	LxX8y/LxXy	$T_C = 50^\circ\text{C}$	0.8	A
I_{TSM}	Non repetitive surge peak on-state current (full cycle, T_j initial = 25°C)	$f = 50\text{ Hz}$	$t = 20\text{ ms}$	8.3	A
		$f = 60\text{ Hz}$	$t = 16.7\text{ ms}$	10	
I^2t	I^2t Value for fusing	$t_p = 8.3\text{ ms}$		0.41	A^2s
di/dt	Critical rate of rise of on-state current ($I_G = 50\text{mA}$ with $\leq 0.1\mu\text{s}$ rise time)	$f = 120\text{ Hz}$	$T_j = 110^\circ\text{C}$	20	$\text{A}/\mu\text{s}$
I_{GTM}	Peak gate trigger current	$t_p = 10\mu\text{s}$	$T_j = 110^\circ\text{C}$	1	A
$P_{G(AV)}$	Average gate power dissipation	$T_j = 110^\circ\text{C}$		0.2	W
T_{stg}	Storage temperature range	LxX8Ey	-65 to 150	°C	
		LxXy	-40 to 150		
T_j	Operating junction temperature range	LxX8Ey	-65 to 110	°C	
		LxXy	-40 to 110		

Note: x = voltage, y = sensitivity

Absolute Maximum Ratings — Standard Triac

Symbol	Parameter	Value	Unit
$I_{T(RMS)}$	RMS on-state current (full sine wave)	QxXE8y/ QxXy $T_C = 60^\circ\text{C}$	0.8 A
I_{TSM}	Non repetitive surge peak on-state current (full cycle, T_J initial = 25°C)	f = 50 Hz t = 20 ms	8.3
		f = 60 Hz t = 16.7 ms	10
I^2t	I^2t Value for fusing	$t_p = 8.3$ ms	0.41 A^2s
di/dt	Critical rate of rise of on-state current ($I_G = 200\text{mA}$ with $\leq 0.1\mu\text{s}$ rise time)	f = 120 Hz $T_J = 125^\circ\text{C}$	20 $\text{A}/\mu\text{s}$
I_{GTM}	Peak gate trigger current	$t_p = 10 \mu\text{s};$ $I_{GT} \leq I_{GTM}$ $T_J = 125^\circ\text{C}$	1 A
$P_{G(AV)}$	Average gate power dissipation	$T_J = 125^\circ\text{C}$	0.2 W
T_{stg}	Storage junction temperature range	L/QxX8Ey	-65 to 150
		L/QxXy	-40 to 150
T_J	Operating junction temperature range	L/QxX8Ey	-65 to 125
		L/QxXy	-40 to 125

Note: x = voltage, y = sensitivity

Electrical Characteristics ($T_J = 25^\circ\text{C}$, unless otherwise specified) — Sensitive Triac (4 Quadrants)

Symbol	Test Conditions	Quadrant	LxX8E3 LxX3	LxX8E5 LxX5	LxX8E6 LxX6	LxX8E8 LxX8	Unit
I_{GT}	$V_D = 12\text{V}$ $R_L = 30 \Omega$	I – II – III	MAX.	3	5	5	10
		IV		3	5	10	20
V_{GT}		ALL	MAX.	1.3			V
V_{GD}	$V_D = V_{DRM}$ $R_L = 3.3 \text{k}\Omega$ $T_J = 110^\circ\text{C}$	ALL	MIN.	0.2			V
I_H	$I_T = 100\text{mA}$		MAX.	5	10	10	15
dv/dt	$V_D = V_{DRM}$ Gate Open $T_J = 100^\circ\text{C}$	400V	TYP.	15	15	25	30
		600V		10	10	20	25
(dv/dt)c	(di/dt)c = 0.43 A/ms $T_J = 110^\circ\text{C}$		TYP.	0.5	1	1	2
t_{gt}	$I_G = 2 \times I_{GT}$ PW = 15 μs $I_T = 1.13 \text{A(pk)}$		TYP.	2.8	3.0	3.0	3.2

Electrical Characteristics ($T_J = 25^\circ\text{C}$, unless otherwise specified) — Standard Triac

Symbol	Test Conditions	Quadrant	QxX8E3 QxX3	QxX8E4 QxX4	Unit
I_{GT}	$V_D = 12\text{V}$ $R_L = 60 \Omega$	I – II – III	MAX.	10	25
		IV	TYP.	25	50
V_{GT}		I – II – III	MAX.	1.3	1.3
V_{GD}	$V_D = V_{DRM}$ $R_L = 3.3 \text{k}\Omega$ $T_J = 125^\circ\text{C}$	ALL	MIN.	0.2	0.2
I_H	$I_T = 200\text{mA}$		MAX.	15	25
dv/dt	$V_D = V_{DRM}$ Gate Open $T_J = 125^\circ\text{C}$	400V	MIN.	25	35
		600V		15	25
(dv/dt)c	(di/dt)c = 0.43 A/ms $T_J = 125^\circ\text{C}$		TYP.	1	1
t_{gt}	$I_G = 2 \times I_{GT}$ PW = 15 μs $I_T = 1.13 \text{A(pk)}$		TYP.	2.5	3.0

Note: x = voltage

Static Characteristics ($T_J = 25^\circ\text{C}$, unless otherwise specified)

Symbol	Test Conditions		Value	Unit			
V_{TM}	$I_{TM} = 1.13\text{A}$ $t_p = 380 \mu\text{s}$	MAX.	1.60	V			
I_{DRM} I_{RRM}	$V_{DRM} = V_{RRM}$	MAX.	LxX8Ey / LxXy	$T_J = 25^\circ\text{C}$	400-600V	2	μA
				$T_J = 110^\circ\text{C}$	400-600V	0.1	mA
			QxX8Ey / QxXy	$T_J = 25^\circ\text{C}$	400-600V	5	μA
				$T_J = 125^\circ\text{C}$	400-600V	1	mA

Thermal Resistances

Symbol	Parameter	Value	Unit
$R_{\theta(J-C)}$	Junction to case (AC)	L/QxX8Ey	60
		L/QxXy	60*
$R_{\theta(J-A)}$	Junction to ambient	L/QxX8Ey	135

Note: * = Mounted on 1 cm² copper (two-ounce) foil surface

Figure 1: Definition of Quadrants

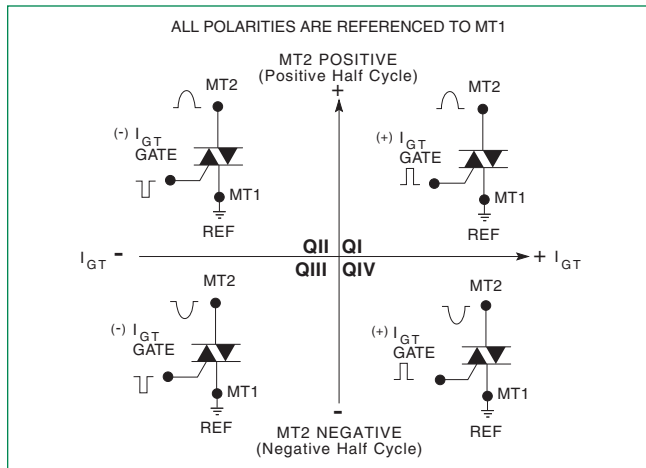
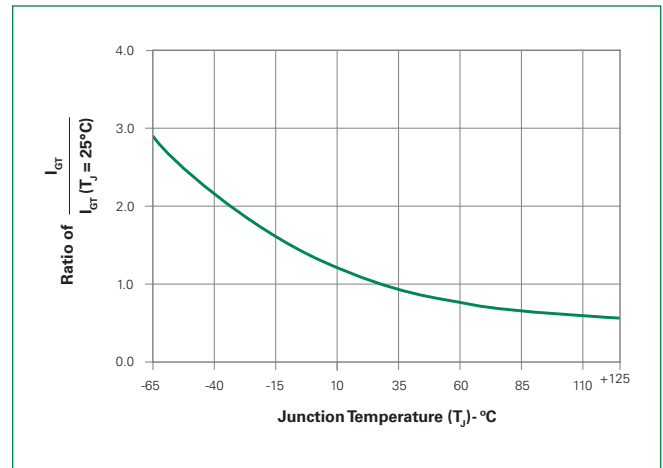
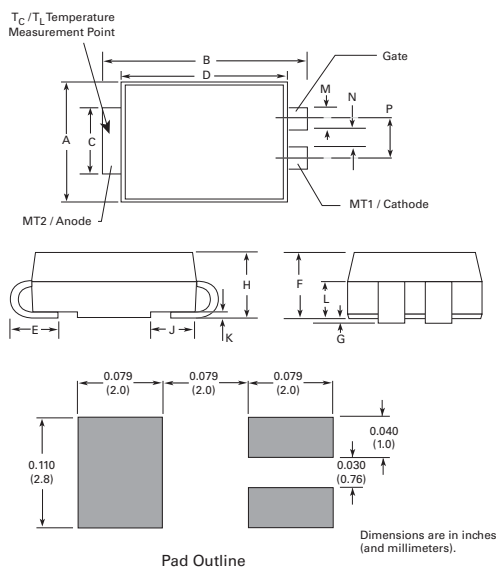

Figure 2: Normalized DC Gate Trigger Current for All Quadrants vs. Junction Temperature



Dimensions — Compak (C Package)

Dimension	Inches		Millimeters	
	Min	Max	Min	Max
A	0.140	0.155	3.56	3.94
B	0.205	0.220	5.21	5.59
C	0.077	0.083	1.96	2.11
D	0.166	0.180	4.22	4.57
E	0.036	0.063	0.91	1.60
F	0.066	0.083	1.67	2.11
G	0.004	0.008	0.10	0.20
H	0.077	0.086	1.96	2.18
J	0.043	0.053	1.09	1.35
K	0.008	0.012	0.20	0.30
L	0.039	0.049	0.99	1.24
M	0.022	0.028	0.56	0.71
N	0.027	0.033	0.69	0.84
P	0.052	0.058	1.32	1.47

0.8 A TRIACS
Product Selector

Part Number	Voltage		Gate Sensitivity Quadrants		Type	Package
	400V	600V	I – II – III	IV		
LxX8E3	X	X	3 mA	3 mA	Sensitive Triac	TO-92
LxX3	X	X	3 mA	3 mA	Sensitive Triac	Compak
LxX8E5	X	X	5 mA	5 mA	Sensitive Triac	TO-92
LxX5	X	X	5 mA	5 mA	Sensitive Triac	Compak
LxX8E6	X	X	5 mA	10 mA	Sensitive Triac	TO-92
LxX8E8	X	X	10 mA	20 mA	Sensitive Triac	TO-92
QxX8E3	X	X	10 mA		Standard Triac	TO-92
QxX3	X	X	10 mA		Standard Triac	Compak
QxX8E4	X	X	25 mA		Standard Triac	TO-92
QxX4	X	X	25 mA		Standard Triac	Compak

Note: x = voltage

Packing Options

Part Number	Marking	Weight	Packing Mode	Base Quantity
L/QxX8Ey	L/QxX8Ey	0.188 g	Bulk	2000
L/QxX8EyRP	L/QxX8Ey	0.188 g	Reel Pack	2000
L/QxX8EyAP	L/QxX8Ey	0.188 g	Ammo Pack	2000
L/QxXyRP	L/QxXy	0.081 g	Embossed Carrier	2500

Note: x = voltage, y = sensitivity

Physical Specifications

Terminal Finish	100% Matte Tin-plated
Body Material	UL recognized epoxy meeting flammability classification 94V-0
Lead Material	Copper Alloy

Design Considerations

Careful selection of the correct device for the application's operating parameters and environment will go a long way toward extending the operating life of the Thyristor. Good design practice should limit the maximum continuous current through the main terminals to 75% of the device rating. Other ways to ensure long life for a power discrete semiconductor are proper heat sinking and selection of voltage ratings for worst case conditions. Overheating, overvoltage (including dv/dt), and surge currents are the main killers of semiconductors. Correct mounting, soldering, and forming of the leads also help protect against component damage.

Environmental Specifications

Test	Specifications and Conditions
AC Blocking	MIL-STD-750, M-1040, Cond A Applied Peak AC voltage @ 125°C for 1008 hours
Temperature Cycling	MIL-STD-750, M-1051, 100 cycles; -40°C to +150°C; 15-min dwell-time
Temperature/Humidity	EIA / JEDEC, JESD22-A101 1008 hours; 320V - DC: 85°C; 85% rel humidity
High Temp Storage	MIL-STD-750, M-1031, 1008 hours; 150°C
Low-Temp Storage	1008 hours; -40°C
Thermal Shock	MIL-STD-750, M-1056 10 cycles; 0°C to 100°C; 5-min dwell-time at each temperature; 10 sec (max) transfer time between temperature
Autoclave	EIA / JEDEC, JESD22-A102 168 hours (121°C at 2 ATMs) and 100% R/H
Resistance to Solder Heat	MIL-STD-750 Method 2031
Solderability	ANSI/J-STD-002, category 3, Test A
Lead Bend	MIL-STD-750, M-2036 Cond E

Dimensions — TO-92 (E Package)

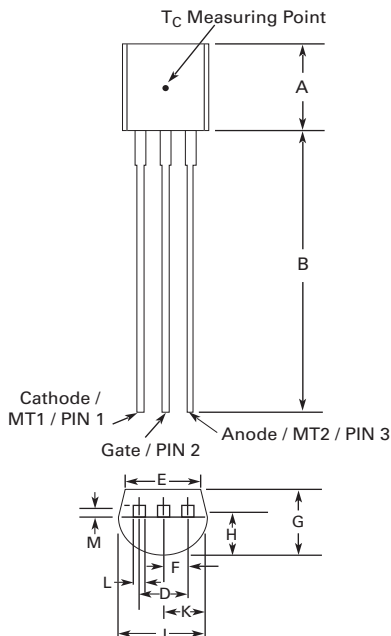

Dimension	Inches		Millimeters	
	Min	Max	Min	Max
A	0.176	0.196	4.47	4.98
B	0.500		12.70	
D	0.095	0.105	2.41	2.67
E	0.150		3.81	
F	0.046	0.054	1.16	1.37
G	0.135	0.145	3.43	3.68
H	0.088	0.096	2.23	2.44
J	0.176	0.186	4.47	4.73
K	0.088	0.096	2.23	2.44
L	0.013	0.019	0.33	0.48
M	0.013	0.017	0.33	0.43

All leads insulated from case. Case is electrically nonconductive.

TO-92 (3-lead) Reel Pack (RP) Radial Leaded Specifications

Meets all EIA-468-B 1994 Standards

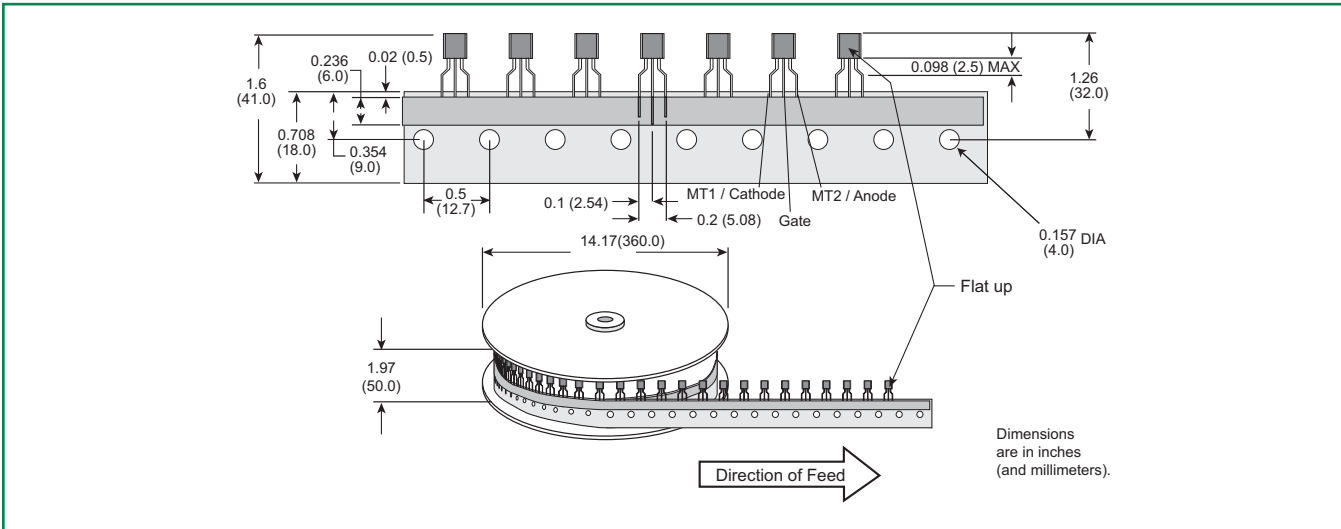

TO-92 (3-lead) Ammo Pack (AP) Radial Leaded Specifications

Meets all EIA-468-B 1994 Standards

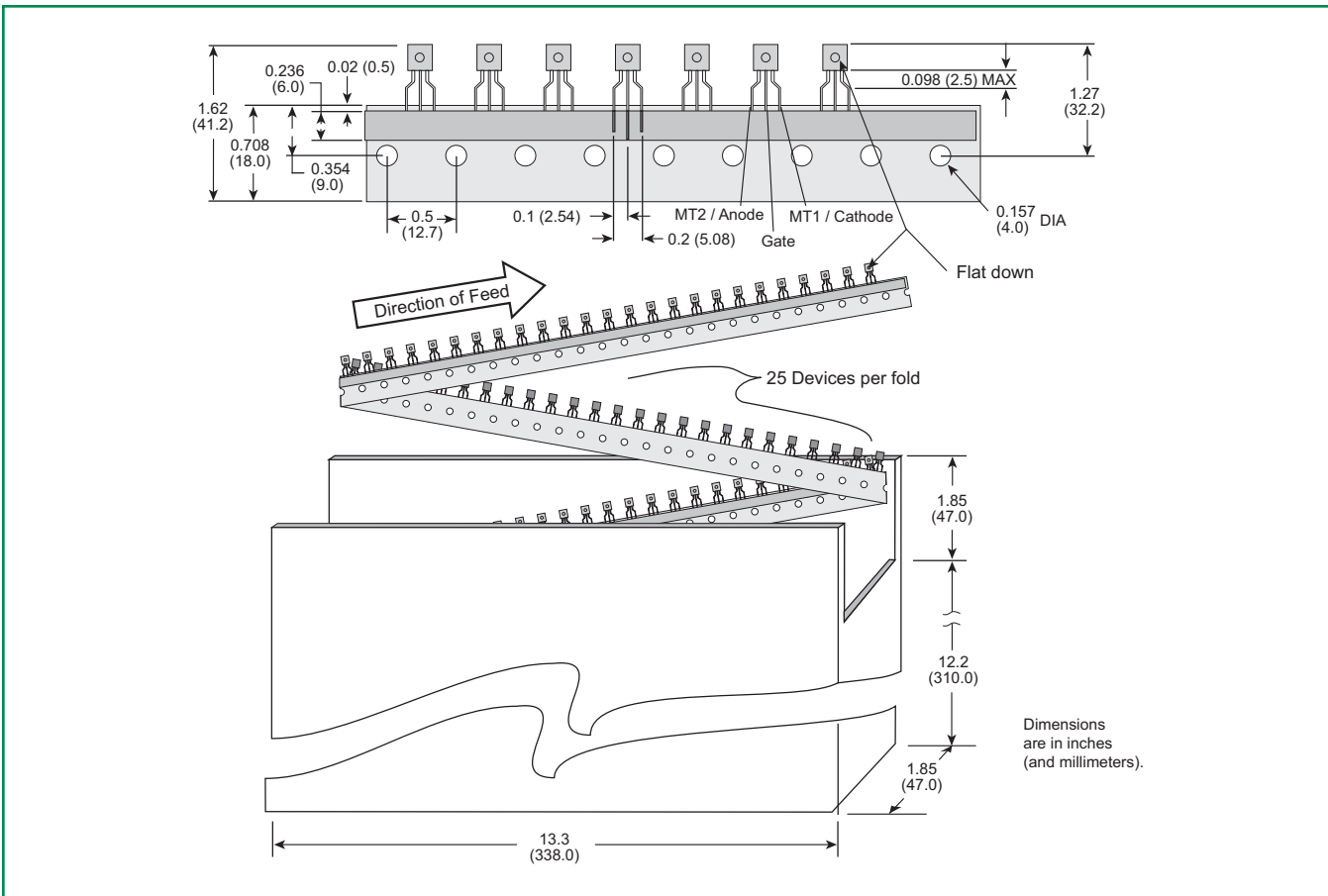

Figure 3: Normalized DC Holding Current vs. Junction Temperature

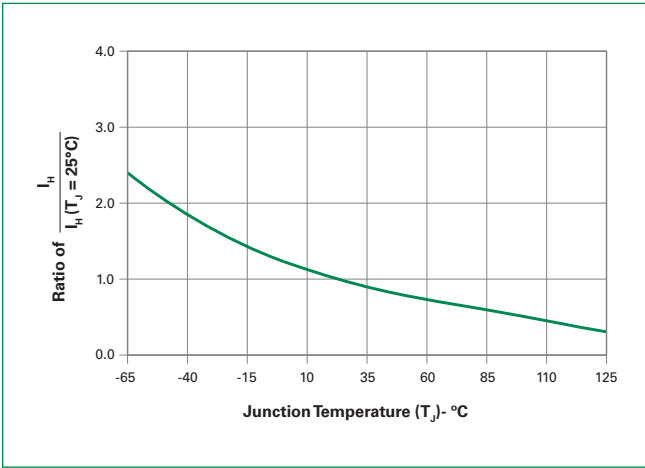

Figure 4: Normalized DC Gate Trigger Voltage for All Quadrants vs. Junction Temperature

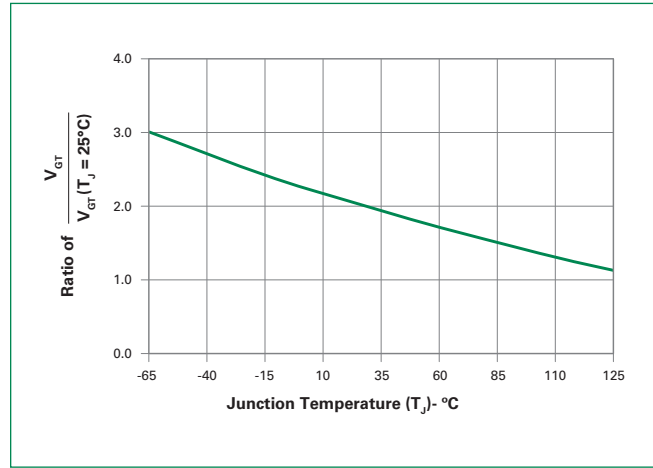

Figure 5: Power Dissipation (Typical) vs. RMS On-State Current

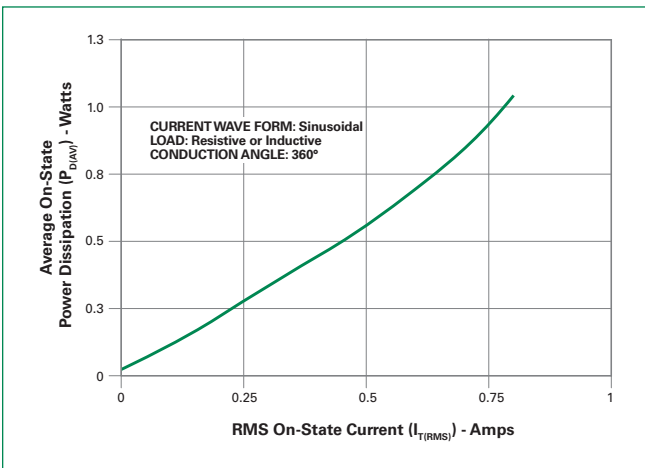

Figure 6: Maximum Allowable Case Temperature vs. On-State Current

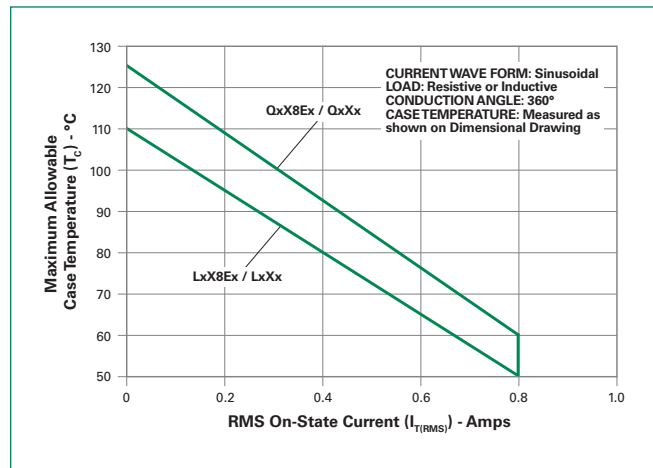

Figure 7: Maximum Allowable Ambient Temperature vs. On-State Current

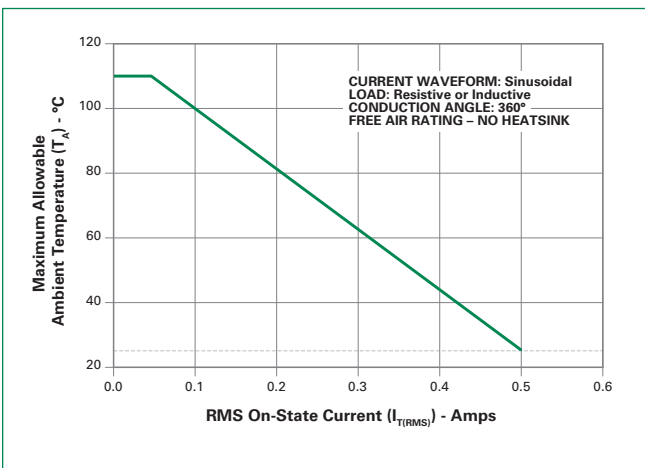

Figure 8: On-State Current vs. On-State Voltage (Typical)

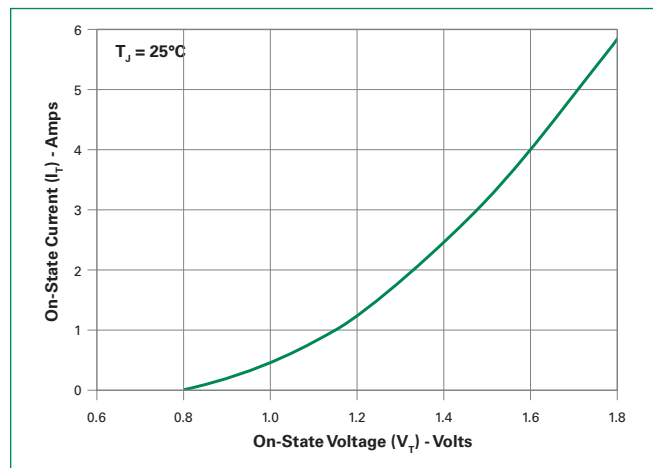
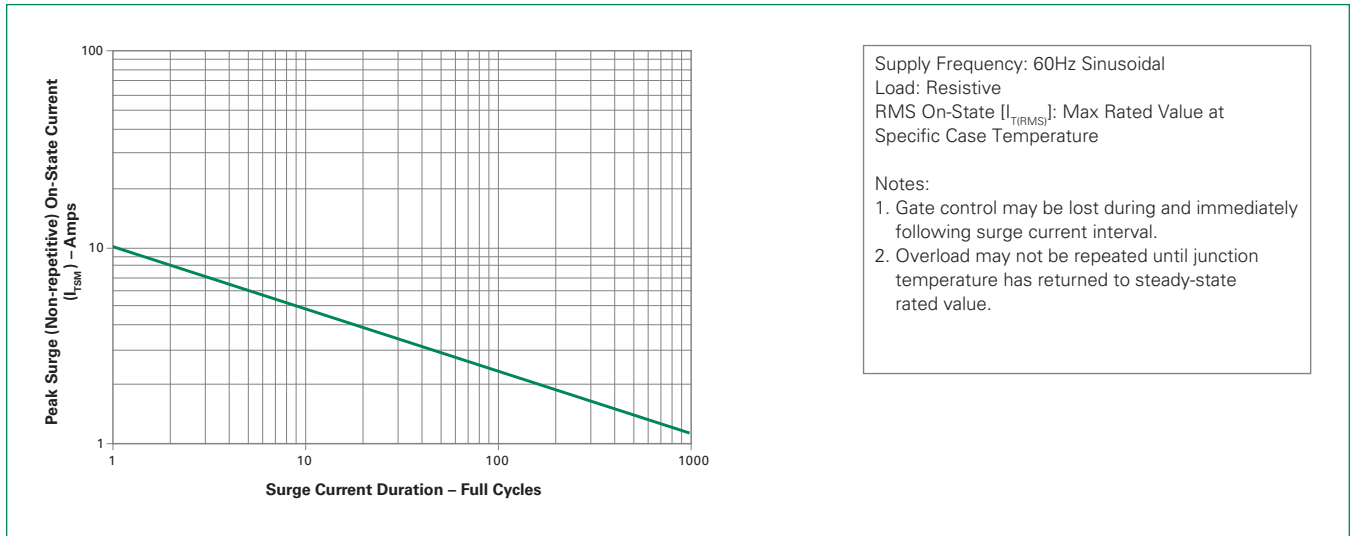
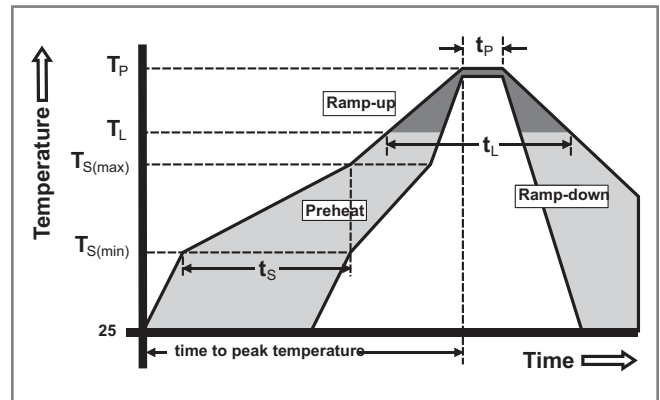

Figure 9: Surge Peak On-State Current vs. Number of Cycles



Soldering Parameters

Reflow Condition	Pb – Free assembly	
Pre Heat	- Temperature Min ($T_{s(min)}$)	150°C
	- Temperature Max ($T_{s(max)}$)	200°C
	- Time (min to max) (t_s)	60 – 190 secs
Average ramp up rate (Liquidus Temp) (T_L) to peak	5°C/second max	
$T_{s(max)}$ to T_L - Ramp-up Rate	5°C/second max	
Reflow	- Temperature (T_L) (Liquidus)	217°C
	- Temperature (t_l)	60 – 150 seconds
Peak Temperature (T_p)	260 ^{+0/-5} °C	
Time within 5°C of actual peak Temperature (t_p)	20 – 40 seconds	
Ramp-down Rate	5°C/second max	
Time 25°C to peak Temperature (T_p)	8 minutes Max.	
Do not exceed	280°C	



Compak Embossed Carrier Reel Pack (RP) Specifications

Meets all EIA-481-1 Standards

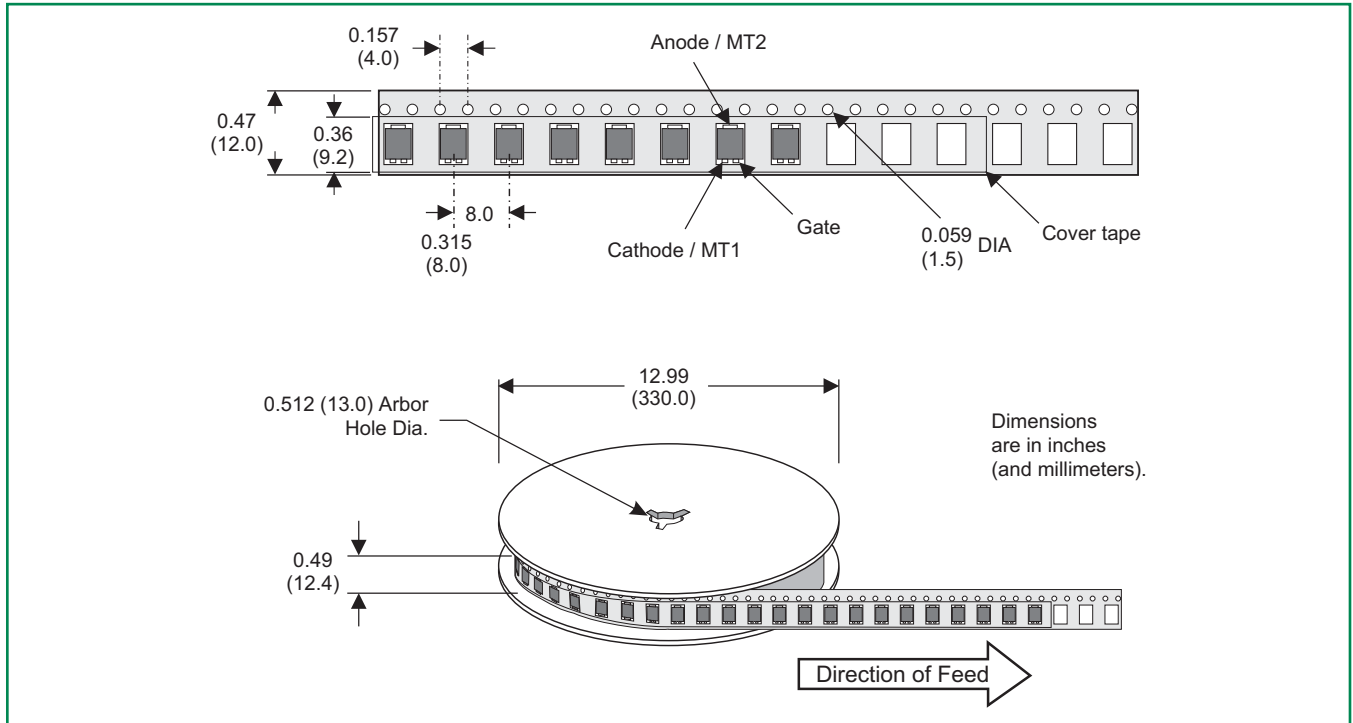

0.8 A TRIACS

Part Numbering System

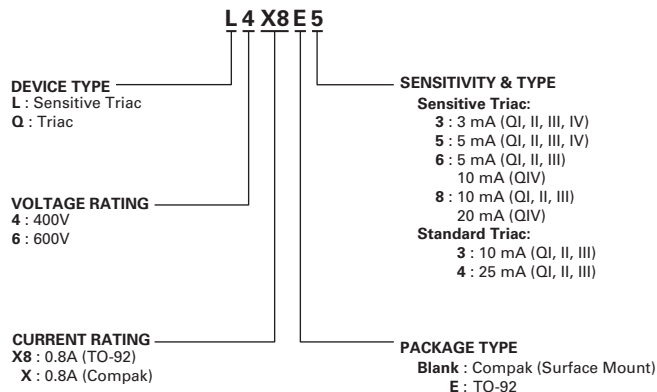

Part Marking System

TO-92 (E Package)

Compak (C Package)

