

DESCRIPTION

The RH37C combines very low noise with excellent precision and high speed specifications. The low $1/f$ noise corner frequency of 2.7Hz combined with $3.5\text{nV}/\sqrt{\text{Hz}}$ 10Hz noise and low offset voltage make the RH37C an excellent choice for low frequency military instrumentation applications. The wafer lots are processed to LTC's in-house Class S flow to yield circuits usable in stringent military applications.

For complete electrical specifications and performance curves see the OP-27/OP-37 data sheet.

ABSOLUTE MAXIMUM RATINGS

Supply Voltage	$\pm 22\text{V}$
Internal Power Dissipation	500mW
Input Voltage	Equal to Supply Voltage
Output Short-Circuit Duration	Indefinite
Differential Input Current (Note 8)	$\pm 25\text{mA}$
Operating Temperature Range	-55°C to 125°C
Junction Temperature Range	-55°C to 150°C
Storage Temperature Range	-65°C to 150°C
Lead Temperature (Soldering, 10 sec)	300°C

 LTC and LT are registered trademarks of Linear Technology Corporation.

BURN-IN CIRCUIT

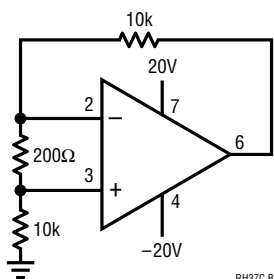

RH37C BI

PACKAGE/ORDER INFORMATION

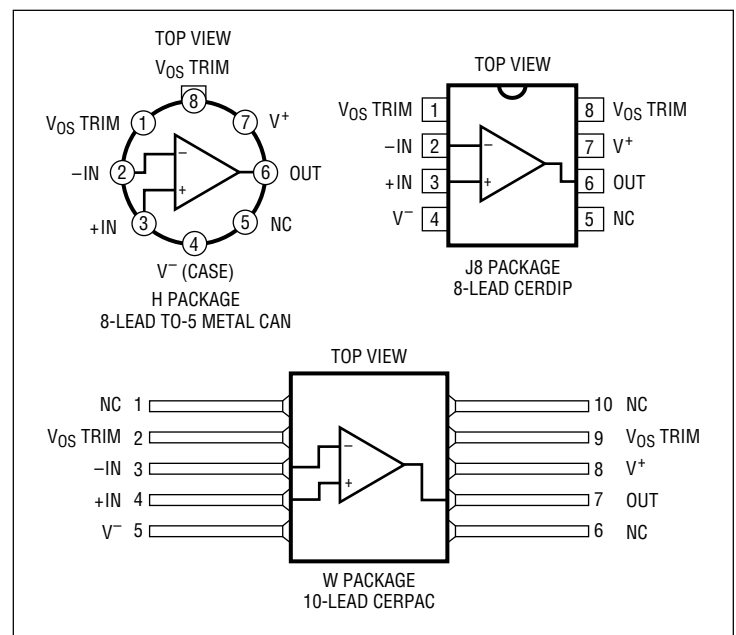

TABLE 1: ELECTRICAL CHARACTERISTICS (Preirradiation) (Note 9)

SYMBOL	PARAMETER	CONDITIONS	NOTES	$T_A = 25^\circ\text{C}$			SUB-GROUP	$-55^\circ\text{C} \leq T_A \leq 125^\circ\text{C}$			SUB-GROUP	UNITS
				MIN	TYP	MAX		MIN	TYP	MAX		
V_{OS}	Input Offset Voltage		1			100	4			300	2, 3	μV
$\frac{\Delta V_{OS}}{\Delta \text{Temp}}$	Average Offset Drift		4, 7							1.8		$\mu\text{V}/^\circ\text{C}$
$\frac{\Delta V_{OS}}{\Delta \text{Time}}$	Long-Term Input Offset Voltage Stability		2, 4			2						$\mu\text{V}/\text{Month}$
I_{OS}	Input Offset Current					75	1			135	2, 3	nA
I_B	Input Bias Current					± 80	1			± 150	2, 3	nA

TABLE 1: ELECTRICAL CHARACTERISTICS (Preirradiation) (Note 9)

SYMBOL	PARAMETER	CONDITIONS	NOTES	$T_A = 25^\circ\text{C}$			SUB-GROUP	$-55^\circ\text{C} \leq T_A \leq 125^\circ\text{C}$			SUB-GROUP	UNITS
				MIN	TYP	MAX		MIN	TYP	MAX		
e_n	Input Noise Voltage	0.1Hz to 10Hz	4, 5			0.25						$\mu\text{V}_{\text{P-P}}$
	Input Noise Voltage Density	$f_0 = 10\text{Hz}$	3			8.0						$\text{nV}/\sqrt{\text{Hz}}$
		$f_0 = 30\text{Hz}$	4			5.6						$\text{nV}/\sqrt{\text{Hz}}$
		$f_0 = 1000\text{Hz}$	4			4.5						$\text{nV}/\sqrt{\text{Hz}}$
i_n	Input Noise Current Density	$f_0 = 1000\text{Hz}$	4, 6			0.6						$\text{pV}/\sqrt{\text{Hz}}$
	Input Resistance Common Mode					2						$\text{G}\Omega$
	Input Voltage Range		4			± 11			± 10.2			V
CMRR	Common Mode Rejection Ratio	$V_{\text{CM}} = \pm 11\text{V}$				100			1			dB
		$V_{\text{CM}} = \pm 10\text{V}$							94		2, 3	dB
PSRR	Power Supply Rejection Ratio	$V_S = \pm 4\text{V}$ to $\pm 18\text{V}$				94			1			dB
		$V_S = \pm 4.5\text{V}$ to $\pm 18\text{V}$							86		2, 3	dB
A_{VOL}	Large-Signal Voltage Gain	$R_L \geq 2\text{k}$, $V_O = \pm 10\text{V}$	4			700			4			V/mV
		$R_L \geq 600\Omega$, $V_O = \pm 1\text{V}$				200			300		5, 6	V/mV
V_{OUT}	Maximum Output Voltage Swing	$R_L = 2\text{k}$				± 11.5			4			V
		$R_L = 600\Omega$				± 10.0			4		± 10.5	5, 6
SR	Slew Rate	$R_L = 2\text{k}$, $A_{\text{VCL}} \geq 5$				11			7			$\text{V}/\mu\text{s}$
GBW	Gain-Bandwidth Product	$f_0 = 10\text{kHz}$ ($A_{\text{VCL}} \geq 5$)	4			45						MHz
		$f_0 = 1\text{MHz}$ ($A_{\text{VCL}} \geq 5$)					40					
Z_0	Open-Loop Output Resistance	$V_O = 0$, $I_O = 0$				470						Ω
P_D	Power Dissipation								1			mW

TABLE 1A: ELECTRICAL CHARACTERISTICS (Postirradiation) (Note 10)

SYMBOL	PARAMETER	CONDITIONS	NOTES	10KRAD(Si)		20KRAD(Si)		50KRAD(Si)		100KRAD(Si)		200KRAD(Si)		UNITS
				MIN	MAX	MIN	MAX	MIN	MAX	MIN	MAX	MIN	MAX	
V_{OS}	Input Offset Voltage		1		100		130		180		280		400	μV
I_{OS}	Input Offset Current				75		75		90		120		180	nA
I_B	Input Bias Current				± 80		± 80		± 125		± 200		± 400	nA
		Input Resistance Common Mode				2 (Typ)		2 (Typ)		2 (Typ)		2 (Typ)		2 (Typ)
	Input Voltage Range		4		± 11		± 11		± 11		± 11		± 11	V
CMRR	Common Mode Rejection Ratio	$V_{\text{CM}} = \pm 11\text{V}$			100		100		97		94		90	dB
PSRR	Power Supply Rejection Ratio	$V_S = \pm 4\text{V}$ to $\pm 18\text{V}$			94		94		92		90		86	dB
A_{VOL}	Large-Signal Voltage Gain	$R_L \geq 2\text{k}$, $V_O = \pm 10\text{V}$			700		700		700		700		400	V/mV
V_{OUT}	Maximum Output Voltage Swing	$R_L \geq 10\text{k}$			± 11.5		± 11.5		± 11.5		± 11.5		± 11.5	V
		$R_L \geq 600\Omega$			± 10.0		± 10.0		± 10.0		± 10.0		± 10.0	V
SR	Slew Rate	$R_L \geq 2\text{k}$			1.7		1.7		1.7		1.5		1	$\text{V}/\mu\text{s}$
Z_0	Open-Loop Output Resistance	$V_O = 0$, $I_O = 0$			70 (Typ)		70 (Typ)		70 (Typ)		70 (Typ)		70 (Typ)	Ω
P_D	Power Dissipation				170		170		170		170		170	mW

TABLE 1A: ELECTRICAL CHARACTERISTICS

Note 1: Input offset voltage measurements are performed by automatic test equipment approximately 0.5 seconds after application of power.

Note 2: Long-term input offset voltage stability refers to the average trend line of offset voltage vs time over the first 30 days of operation. Excluding the initial hour of operation, changes in V_{OS} during the first 30 days are typically $2.5\mu\text{V}$. Refer to the typical performance curves.

Note 3: Sample tested to an LTPD of 15 on every lot. Contact factory for 100% testing of 10Hz voltage density noise.

Note 4: Parameter is guaranteed by design, characterization, or correlation to other tested parameters.

Note 5: See test circuit and frequency response curve for 0.1Hz to 10Hz tester on OP-27/OP-37 data sheet.

Note 6: See test circuit for current noise measurement on OP-27/OP-37 data sheet.

Note 7: The average input offset drift performance is within the specifications unnullled or when nulled with a pot having a range $8k\Omega$ to $20k\Omega$.

Note 8: The RH37C's inputs are protected by back-to-back diodes. Current limiting resistors are not used in order to achieve low noise. If differential input voltage exceeds $\pm 0.7\text{V}$, the input current should be limited to 25mA.

Note 9: $V_S = \pm 15\text{V}$, $V_{CM} = 0\text{V}$ unless otherwise noted.

Note 10: $T_A = 25^\circ\text{C}$, $V_S = \pm 15\text{V}$, $V_{CM} = 0\text{V}$, unless otherwise noted.

TOTAL DOSE BIAS CIRCUIT

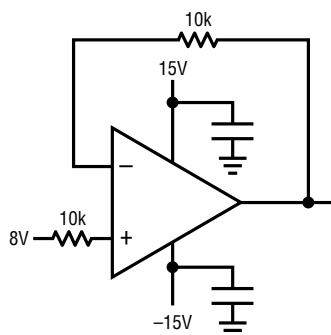

TYPICAL PERFORMANCE CHARACTERISTICS

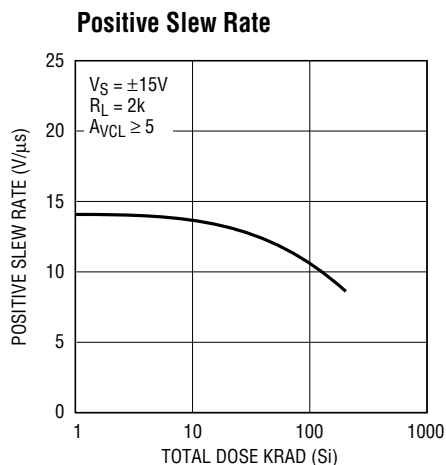

RH37C G01

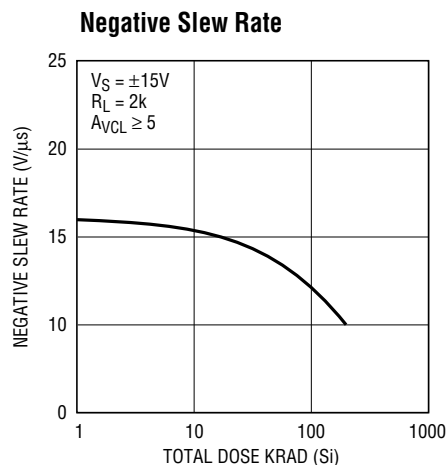

RH37C G02

TYPICAL PERFORMANCE CHARACTERISTICS

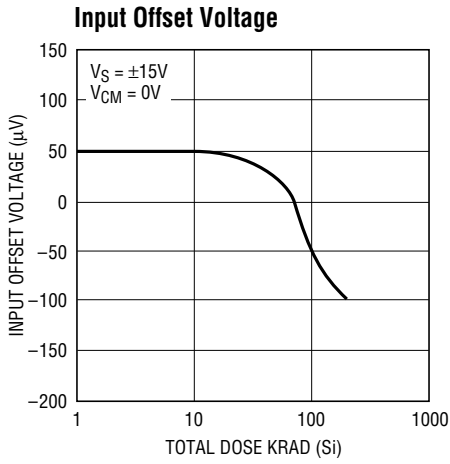

RH37C G03

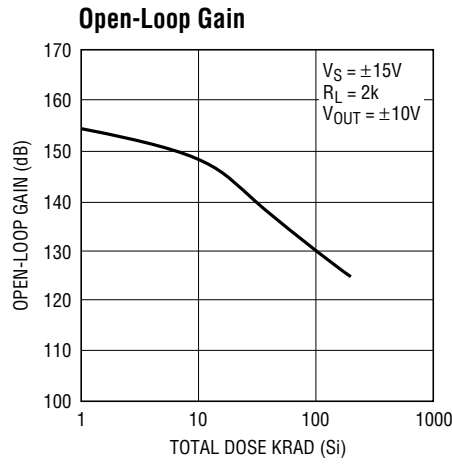

RH37C G04

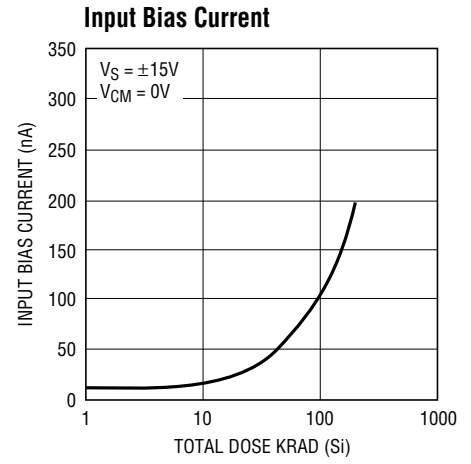

RH37C G05

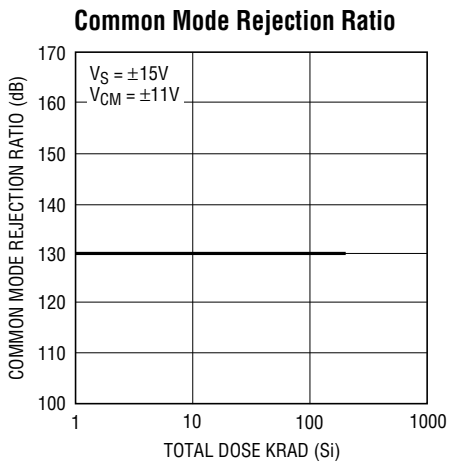

RH37C G06

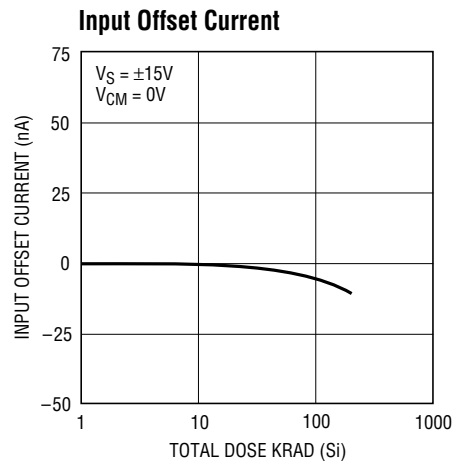

RH37C G07

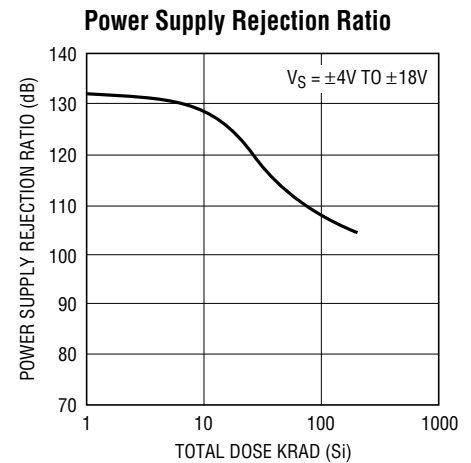

RH37C G08

TABLE 2: ELECTRICAL TEST REQUIREMENTS

MIL-STD-883 TEST REQUIREMENTS	SUBGROUP
Final Electrical Test Requirements (Method 5004)	1*,2,3,4,5,6,7
Group A Test Requirements (Method 5005)	1,2,3,4,5,6,7
Group B and D for Class S, and Group C and D for Class B	1
End Point Electrical Parameters (Method 5005)	

* PDA applies to subgroup 1. See PDA Test Notes.

PDA Test Notes

The PDA is specified as 5% based on failures from group A, subgroup 1, tests after cooldown as the final electrical test in accordance with method 5004 of MIL-STD-883 Class B. The verified failures of group A, subgroup 1, after burn-in divided by the total number of devices submitted for burn-in in that lot shall be used to determine the percent for the lot.

Linear Technology Corporation reserves the right to test to tighter limits than those given.



- [中文网站](#)
- [日本サイト](#)
- [Quality](#)
- [Careers](#)
- [Contact Us](#)
- [MyLinear](#)



- [PRODUCTS](#)
- [SOLUTIONS](#)
- [DESIGN SUPPORT](#)
- [PURCHASE](#)
- [COMPANY](#)

Space Qualified Products

[Home](#) > [Products](#) > [Space and Harsh Environment](#) > [Space Qualified Products](#)
> [Radiation Hardened \(Rad Hard\) Op Amps and Comparators](#) > [RH37C](#)

- [Radiation Hardened \(Rad Hard\) Op Amps and Comparators](#)
- [Radiation Hardened \(Rad Hard\) Regulators](#)
- [Radiation Hardened \(Rad Hard\) Voltage References](#)
- [Military JAN S Products](#)

RH37C - Precision Operational Amplifier

- DESCRIPTION
- PACKAGING
- ORDER INFO
- SIMULATE
-  [Print Friendly](#)

Features

- ABSOLUTE MAXIMUM RATINGS
- Supply Voltage $\pm 22\text{V}$
- Internal Power Dissipation 500mW
- Input Voltage Equal to Supply Voltage
- Output Short-Circuit Duration Indefinite
- Differential Input Voltage (Note 8) $\pm 25\text{mA}$
- Operating Temperature Range -55°C to 125°C
- Junction Temperature Range -55°C to 150°C
- Storage Temperature Range -65°C to 150°C
- Lead Temperature (Soldering, 10 sec) 300°C

Typical Application

BURN-IN CIRCUIT

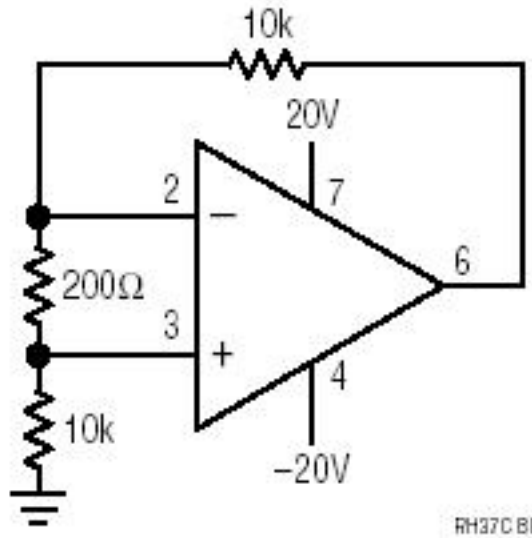

[Back to Top](#)

Description

The RH37C combines very low noise with excellent precision and high speed specifications. The low $1/f$ noise corner frequency of 2.7Hz combined with $3.5\text{nV}\sqrt{\text{rtHz}}$ 10Hz noise and low offset voltage make the RH37C an excellent choice for low frequency military instrumentation applications. The wafer lots are processed to LTC's in-house Class S flow to yield circuits usable in stringent military applications.

For complete electrical specifications and performance curves see the OP-27/OP-37 data sheet.

[Back to Top](#)

Packaging

TO-5, DIP-8, FLATPAK-10 (Glass Sealed)

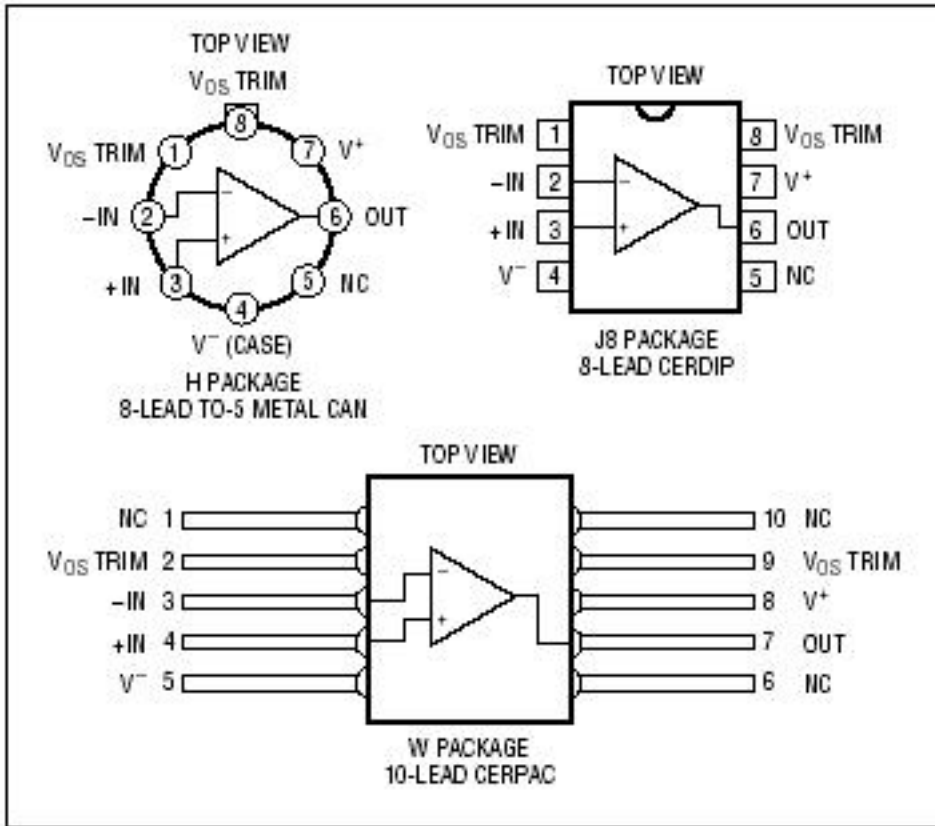

[Back to Top](#)

Order Info

- Part numbers ending in PBF are [lead free](#). Please contact LTC marketing for information on lead based finish parts.
- Part numbers containing TR or TRM are shipped in [tape and reel or 500 unit mini tape and reel](#), respectively
- Please refer to our [general ordering information](#) or the product datasheet for more details

Package Variations and Pricing

Part Number	Package	Pins	Temp	Price (1-99)	Price (1k)*	RoHS Data
OP37EN8	PDIP	8	C	\$5.00	\$4.05	View
OP37EN8#PBF	PDIP	8	C	\$5.00	\$4.05	View

OP37GN8	PDIP	8	C	\$3.40	\$2.75	View
OP37GN8#PBF	PDIP	8	C	\$3.40	\$2.75	View
OP37GS8	SO	8	C	\$3.50	\$2.85	View
OP37GS8#PBF	SO	8	C	\$3.50	\$2.85	View
OP37GS8#TR	SO	8	C		\$2.91	View
OP37GS8#TRPBF	SO	8	C		\$2.91	View
Buy Now						
Request Samples						

* The USA list pricing shown is for BUDGETARY USE ONLY, shown in United States dollars (FOB USA per unit for the stated volume), and is subject to change. International prices may differ due to local duties, taxes, fees and exchange rates. For volume-specific price or delivery quotes, please contact your local Linear Technology [sales office or authorized distributor](#).

[Back to Top](#)

Applications

[Back to Top](#)

Simulate

To simulate selected Linear Technology products, please download [LTSpice / SwitcherCAD III](#). This powerful schematic capture and simulation tool includes macro models for 80% of Linear Technology's switching regulators, over 200 op amp models, as well as resistors, transistors and MOSFET models.

For other simulation tools, visit our [Design Simulation and Device Models](#) page.

[Back to Top](#)

This product is not currently available for order online. Please contact your local sales office or distributor for availability.

Documentation

Datasheet

- [RH37C - Dice Data Sheet](#)
- [RH37C - Precision Operational Amplifier](#)

Spec Notice

- [RH37C - SPEC NO. 05-08-5030](#)

Reliability Data

- [R301 RH Reliability Data](#)

- [Site Help](#)
- [Site Map](#)
- [Site Index](#)
- [Send Us Feedback](#)
- [■](#)