

## Features

- Fast Switching Speed
- Surface Mount Package Ideally Suited for Automated Insertion
- For General Purpose Switching Applications
- High Conductance
- **Lead Free/RoHS Compliant (Note 3)**
- **"Green" Device (Notes 4 and 5)**

## Mechanical Data

- Case: SOT-323
- Case Material: Molded Plastic, "Green" Molding Compound, Note 5. UL Flammability Classification Rating 94V-0
- Moisture Sensitivity: Level 1 per J-STD-020D
- Terminals: Finish - Matte Tin. Solderable per MIL-STD-202, Method 208
- Lead Free Plating (Matte Tin Finish annealed over Copper leadframe)
- Polarity: See Diagram
- Marking Information: See Page 2
- Ordering Information: See Page 2
- Weight: 0.006 grams (approximate)

SOT-323

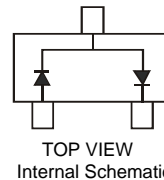

## Maximum Ratings @ $T_A = 25^\circ\text{C}$ unless otherwise specified

Characteristic	Symbol	Value	Unit
Repetitive Peak Reverse Voltage	$V_{RRM}$	300	V
Working Peak Reverse Voltage DC Blocking Voltage	$V_{RWM}$ $V_R$	240	V
RMS Reverse Voltage	$V_{R(RMS)}$	170	V
Forward Continuous Current	$I_F$	225	mA
Peak Repetitive Forward Current	$I_{FRM}$	625	mA
Non-Repetitive Peak Forward Surge Current	$I_{FSM}$	4.0 1.0	A
	@ $t = 1.0\mu\text{s}$		
	@ $t = 1.0\text{s}$		

## Thermal Characteristics

Characteristic	Symbol	Value	Unit
Power Dissipation (Note 1)	$P_D$	250	mW
Thermal Resistance Junction to Ambient Air (Note 1)	$R_{\theta JA}$	500	$^\circ\text{C/W}$
Operating and Storage Temperature Range	$T_J, T_{STG}$	-65 to +150	$^\circ\text{C}$

## Electrical Characteristics @ $T_A = 25^\circ\text{C}$ unless otherwise specified

Characteristic	Symbol	Min	Max	Unit	Test Condition
Reverse Breakdown Voltage (Note 2)	$V_{(BR)R}$	300	—	V	$I_R = 100\mu\text{A}$
Forward Voltage	$V_F$	—	0.87 1.0	V	$I_F = 20\text{mA}$ $I_F = 100\text{mA}$
Peak Reverse Current (Note 2)	$I_R$	—	100	nA $\mu\text{A}$	$V_R = 240\text{V}$ $V_R = 240\text{V}, T_J = 150^\circ\text{C}$
Total Capacitance, per Element	$C_T$	—	5.0	pF	$V_R = 0, f = 1.0\text{MHz}$
Reverse Recovery Time	$t_{rr}$	—	50	ns	$I_F = I_R = 30\text{mA}$ , $I_{rr} = 3.0\text{mA}, R_L = 100\Omega$

- Notes:
1. Part mounted on FR-4 PC Board with recommended pad layout, which can be found on our website at <http://www.diodes.com/datasheets/ap02001.pdf>.
  2. Short duration pulse test used to minimize self-heating effect.
  3. No purposefully added lead.
  4. Diodes Inc.'s "Green" policy can be found on our website at [http://www.diodes.com/products/lead\\_free/index.php](http://www.diodes.com/products/lead_free/index.php).
  5. Product manufactured with Date Code 0627 (week 27, 2006) and newer are built with Green Molding Compound. Product manufactured prior to Date Code 0627 are built with Non-Green Molding Compound and may contain Halogens or Sb2O3 Fire Retardants.

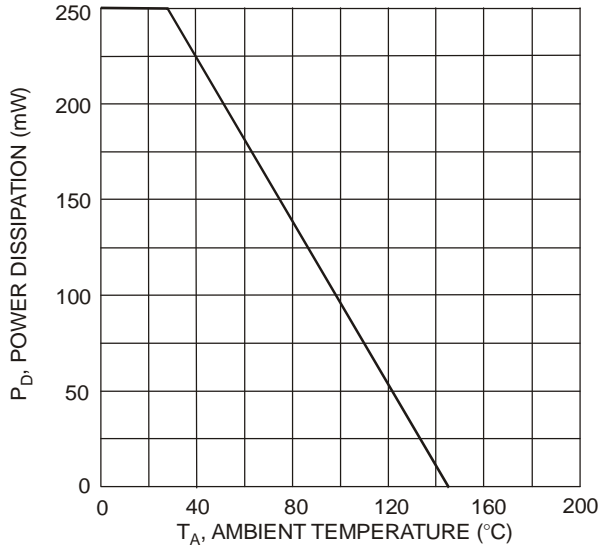

Fig. 1 Power Derating Curve, Total Package

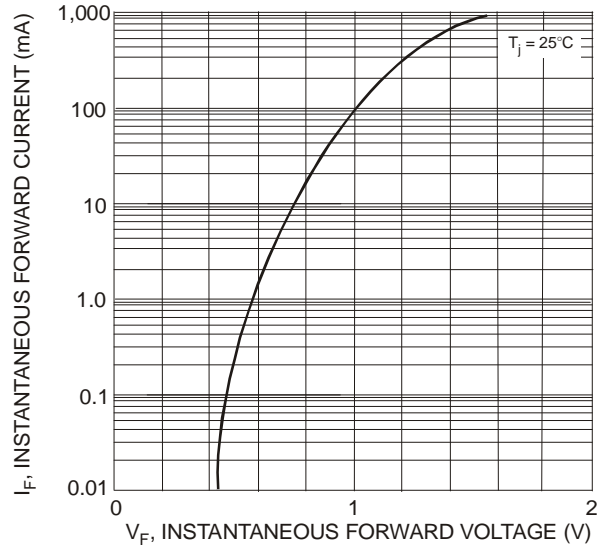

Fig. 2 Typical Forward Characteristics, Per Element

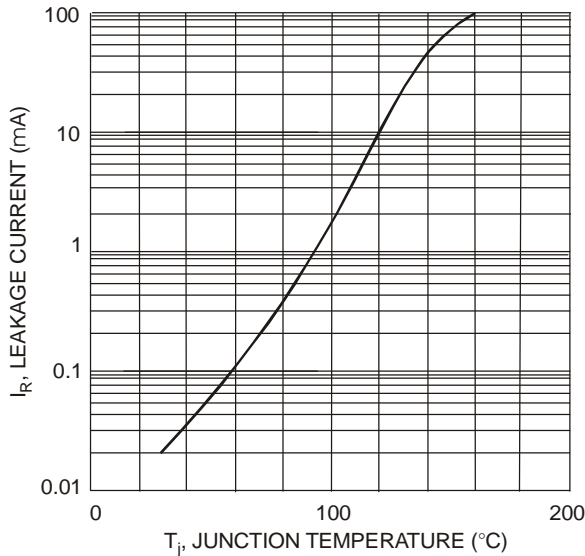

Fig. 3 Leakage Current vs. Junction Temperature, Per Element

**Ordering Information** (Notes 5 & 6)

Part Number	Case	Packaging
MMBD2004SW-7-F	SOT-323	3000/Tape & Reel

Notes: 6. For packaging details, go to our website at <http://www.diodes.com/datasheets/ap02007.pdf>.

**Marking Information**

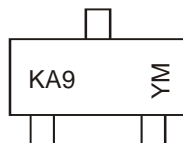

KA9= Product Type Marking Code  
 YM = Date Code Marking  
 Y = Year ex: T = 2006  
 M = Month ex: 9 = September

Date Code Key

Year	2003	2004	2005	2006	2007	2008	2009	2010	2011	2012
Code	P	R	S	T	U	V	W	X	Y	Z

Month	Jan	Feb	Mar	Apr	May	Jun	Jul	Aug	Sep	Oct	Nov	Dec
Code	1	2	3	4	5	6	7	8	9	O	N	D

**Package Outline Dimensions**

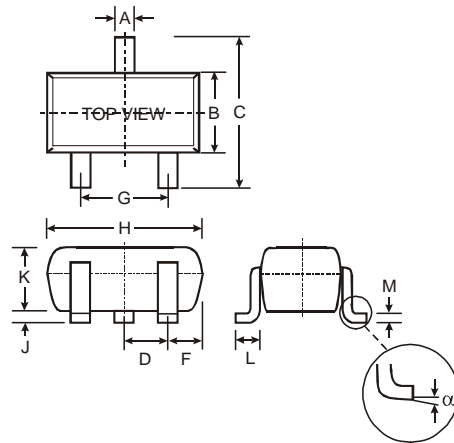

SOT-323		
Dim	Min	Max
A	0.25	0.40
B	1.15	1.35
C	2.00	2.20
D	0.65 Nominal	
F	0.30	0.40
G	1.20	1.40
H	1.80	2.20
J	0.0	0.10
K	0.90	1.00
L	0.25	0.40
M	0.10	0.18
α	0°	8°
All Dimensions in mm		

**Suggested Pad Layout**

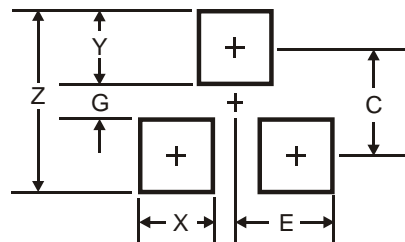

Dimensions	Value (in mm)
Z	2.8
G	1.0
X	0.7
Y	0.9
C	1.9
E	0.65

**IMPORTANT NOTICE**

Diodes Incorporated and its subsidiaries reserve the right to make modifications, enhancements, improvements, corrections or other changes without further notice to any product herein. Diodes Incorporated does not assume any liability arising out of the application or use of any product described herein; neither does it convey any license under its patent rights, nor the rights of others. The user of products in such applications shall assume all risks of such use and will agree to hold Diodes Incorporated and all the companies whose products are represented on our website, harmless against all damages.

**LIFE SUPPORT**

Diodes Incorporated products are not authorized for use as critical components in life support devices or systems without the expressed written approval of the President of Diodes Incorporated.