

RoHS Lxx04xx & Qxx04xx Series

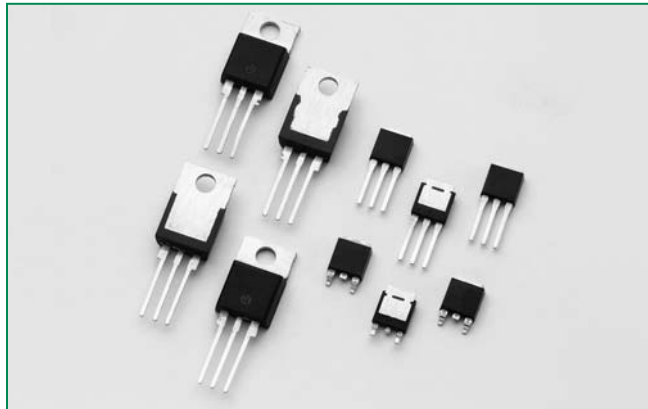

Description

4 Amp bi-directional solid state switch series is designed for AC switching and phase control applications such as motor speed and temperature modulation controls, lighting controls, and static switching relays.

Sensitive type devices guarantee gate control in Quadrants I & IV needed for digital control circuitry.

Standard type devices normally operate in Quadrants I & III triggered from AC line.

Features & Benefits

- RoHS Compliant
- Glass – passivated junctions
- Voltage capability up to 1000 V
- Surge capability up to 55 A
- Electrically isolated “L-Package” is UL recognized for 2500Vrms
- Solid-state switching eliminates arcing or contact bounce that create voltage transients
- No contacts to wear out from reaction of switching events
- Restricted (or limited) RFI generation, depending on activation point of sine wave
- Requires only a small gate activation pulse in each half-cycle

Agency Approval

Agency	Agency File Number
	L Package : E71639

Main Features

Symbol	Value	Unit
$I_{T(RMS)}$	4	A
V_{DRM} / V_{RRM}	400 to 1000	V
$I_{GT (Q1)}$	3 to 25	mA

Schematic Symbol

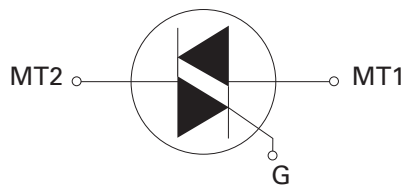

Applications

Typical applications are AC solid-state switches, power tools, home/brown goods and white goods appliances.

Sensitive gate Triacs can be directly driven by microprocessor or popular opto-couplers/isolators.

Internally constructed isolated packages are offered for ease of heat sinking with highest isolation voltage.

Absolute Maximum Ratings – Sensitive Triacs (4 Quadrants)

Symbol	Parameter	Value	Unit	
$I_{T(RMS)}$	RMS on-state current (full sine wave)	Lxx04Ly / Lxx04Dy $T_c = 85^\circ C$	4	A
		Lxx04Ry / Lxx04Vy $T_c = 75^\circ C$		
I_{TSM}	Non repetitive surge peak on-state current (full cycle, T_j initial = $25^\circ C$)	f = 50 Hz t = 20 ms	33	A
		f = 60 Hz t = 16.7 ms		
I^2t	I^2t Value for fusing	$t_p = 8.3$ ms	6.6	A ² s
di/dt	Critical rate of rise of on-state current ($I_g = 50$ mA with ≤ 0.1 µs rise time)	f = 120 Hz $T_j = 110^\circ C$	50	A/µs
I_{GTM}	Peak gate trigger current	$t_p \leq 10$ µs $T_j = 110^\circ C$	1.2	A
$P_{G(AV)}$	Average gate power dissipation	$T_j = 110^\circ C$	0.3	W
T_{stg}	Storage temperature range		-40 to 150	°C
T_j	Operating junction temperature range		-40 to 110	°C

Note: xx = voltage, y = sensitivity

Absolute Maximum Ratings — Standard Triacs

Symbol	Parameter			Value	Unit
$I_{T(RMS)}$	RMS on-state current (full sine wave)	Qxx04Ly / Qxx04Dy	$T_C = 95^\circ\text{C}$	4	A
		Qxx04Ry / Qxx04Vy	$T_C = 85^\circ\text{C}$		
I_{TSM}	Non repetitive surge peak on-state current (full cycle, T_J initial = 25°C)	f = 50 Hz	t = 20 ms	46	A
		f = 60 Hz	t = 16.7 ms	55	
I^2t	I^2t Value for fusing	$t_p = 8.3$ ms		12.5	A^2s
di/dt	Critical rate of rise of on-state current ($I_G = 50\text{mA}$ with $\leq 0.1\mu\text{s}$ rise time)	f = 120 Hz	$T_J = 125^\circ\text{C}$	50	$\text{A}/\mu\text{s}$
I_{GTM}	Peak gate trigger current	$t_p \leq 10 \mu\text{s};$ $I_{GT} \leq I_{GTM}$	$T_J = 125^\circ\text{C}$	1.2	A
$P_{G(AV)}$	Average gate power dissipation		$T_J = 125^\circ\text{C}$	0.3	W
T_{stg}	Storage temperature range			-40 to 150	$^\circ\text{C}$
T_J	Operating junction temperature range			-40 to 125	$^\circ\text{C}$

Note: xx = voltage, y = sensitivity

Electrical Characteristics ($T_J = 25^\circ\text{C}$, unless otherwise specified) — Sensitive Triac (4 Quadrants)

Symbol	Test Conditions	Quadrant	Lxx04x3	Lxx04x5	Lxx04x6	Lxx04x8	Unit
I_{GT}	$V_D = 12\text{V}$ $R_L = 60 \Omega$	I – II – III	3	5	5	10	mA
		IV	3	5	10	20	
V_{GT}		ALL	1.3				V
V_{GD}	$V_D = V_{DRM}$ $R_L = 3.3 \text{ k}\Omega$ $T_J = 110^\circ\text{C}$	ALL	0.2				V
I_H	$I_T = 100\text{mA}$	MAX.	5	10	10	15	mA
dv/dt	$V_D = V_{DRM}$ Gate Open $T_J = 100^\circ\text{C}$	400V	25	25	30	35	$\text{V}/\mu\text{s}$
		600V	15	15	20	25	
(dv/dt)c	(di/dt)c = 2.16 A/ms $T_J = 110^\circ\text{C}$	TYP.	0.5	1	1	1	$\text{V}/\mu\text{s}$
t_{gt}	$I_G = 2 \times I_{GT}$ $\text{PW} = 15\mu\text{s}$ $I_T = 5.6 \text{ A(pk)}$	TYP.	2.8	3.0	3.0	3.2	μs

Electrical Characteristics ($T_J = 25^\circ\text{C}$, unless otherwise specified) — Standard Triac

Symbol	Test Conditions	Quadrant	Qxx04x3	Qxx04x4	Unit
I_{GT}	$V_D = 12\text{V}$ $R_L = 60 \Omega$	I – II – III	10	25	mA
		IV	25	50	
V_{GT}		I – II – III	1.3	1.3	V
V_{GD}	$V_D = V_{DRM}$ $R_L = 3.3 \text{ k}\Omega$ $T_J = 125^\circ\text{C}$	ALL	0.2	0.2	V
I_H	$I_T = 200\text{mA}$	MAX.	20	30	mA
dv/dt	$V_D = V_{DRM}$ Gate Open $T_J = 125^\circ\text{C}$	400V	40	75	$\text{V}/\mu\text{s}$
		600V	30	50	
		800V		40	
	$V_D = V_{DRM}$ Gate Open $T_J = 100^\circ\text{C}$	1000V		50	
(dv/dt)c	(di/dt)c = 2.16 A/ms $T_J = 125^\circ\text{C}$	TYP.	2	2	$\text{V}/\mu\text{s}$
t_{gt}	$I_G = 2 \times I_{GT}$ $\text{PW} = 15\mu\text{s}$ $I_T = 5.6 \text{ A(pk)}$	TYP.	2.5	3.0	μs

Note: xx = voltage, x = package

Static Characteristics ($T_J = 25^\circ\text{C}$, unless otherwise specified)

Symbol	Test Conditions		Value	Unit		
V_{TM}	$I_{TM} = 5.6\text{A}$ $t_p = 380 \mu\text{s}$	MAX.	1.60	V		
I_{DRM} I_{RRM}	$V_{DRM} = V_{RRM}$	MAX.	Lxx04xy	$T_J = 25^\circ\text{C}$ 400-600V	5	μA
				$T_J = 110^\circ\text{C}$ 400-600V	200	μA
			Qxx04xy	$T_J = 25^\circ\text{C}$ 400-1000V	10	μA
				$T_J = 125^\circ\text{C}$ 400-800V	2	mA
				$T_J = 100^\circ\text{C}$ 1000V	3	

Thermal Resistances

Symbol	Parameter	Value	Unit
$R_{\theta(J-C)}$	Junction to case (AC)	L/Qxx04Dy	3.5
		L/Qxx04Ly	3.6
		L/Qxx04Ry / L/Qxx04Vy	6.0
$R_{\theta(J-A)}$	Junction to ambient	L/Qxx04Ly	50
		L/Qxx04Ry / L/Qxx04Vy	70

Note: xx = voltage, x = package, y = sensitivity

Figure 1: Definition of Quadrants

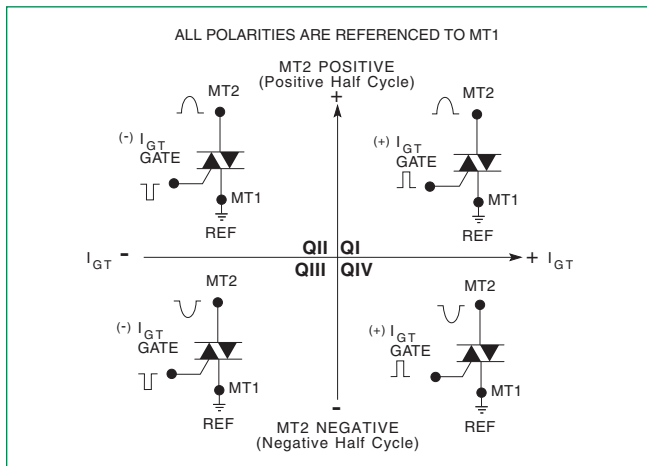

Figure 2: Normalized DC Gate Trigger Current for All Quadrants vs. Junction Temperature

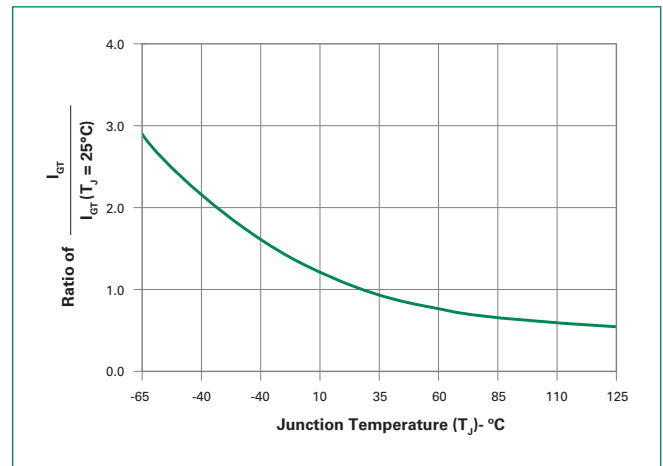

Figure 3: Normalized DC Holding Current vs. Junction Temperature

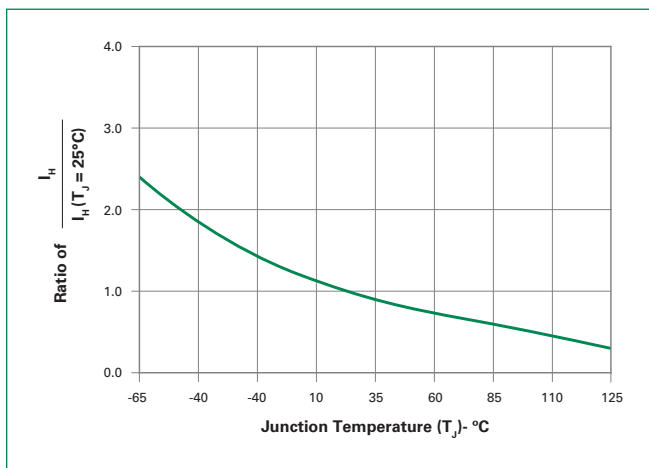

Figure 4: Normalized DC Gate Trigger Voltage for All Quadrants vs. Junction Temperature

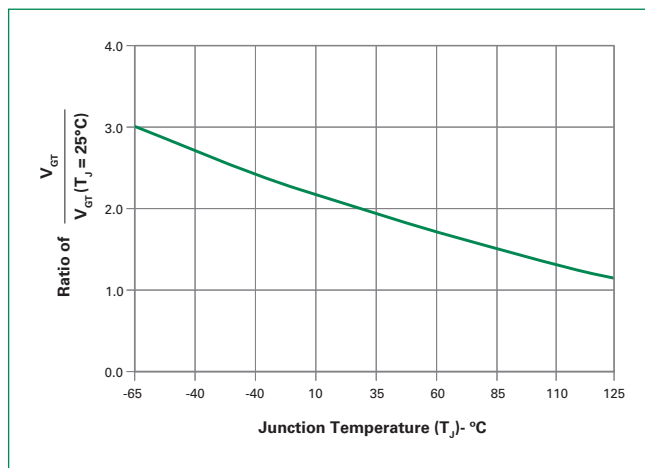

Figure 5: Power Dissipation (Typical) vs. RMS On-State Current

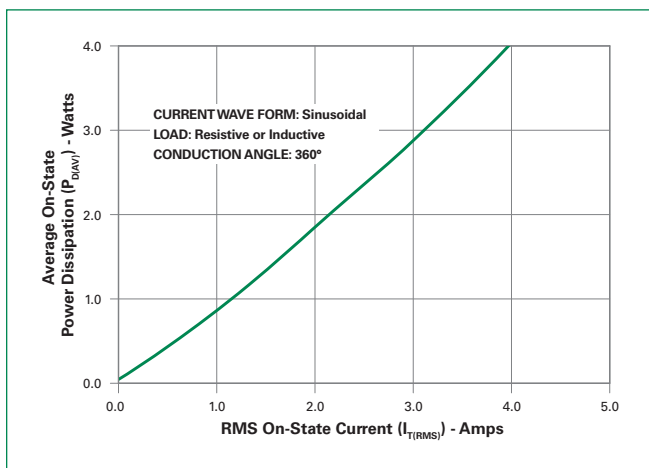

Figure 6: Maximum Allowable Case Temperature vs. On-State Current

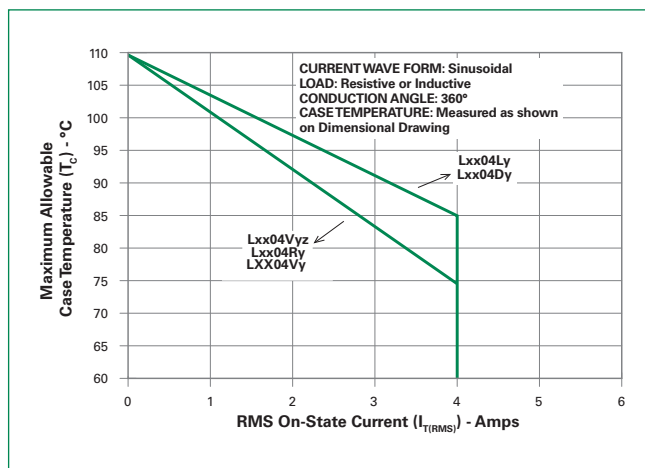

Figure 7: Maximum Allowable Case Temperature vs. On-State Current

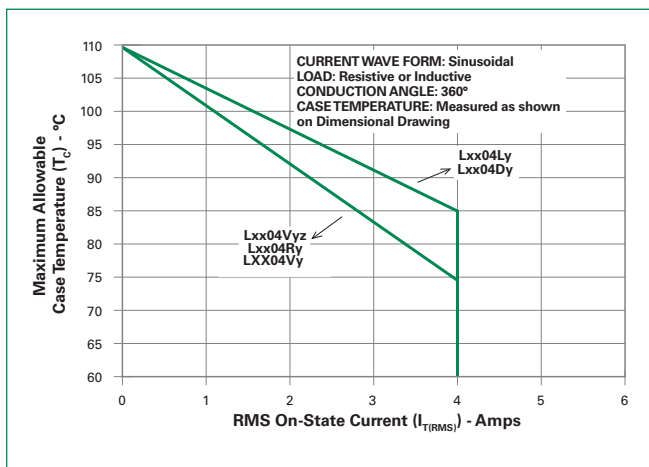
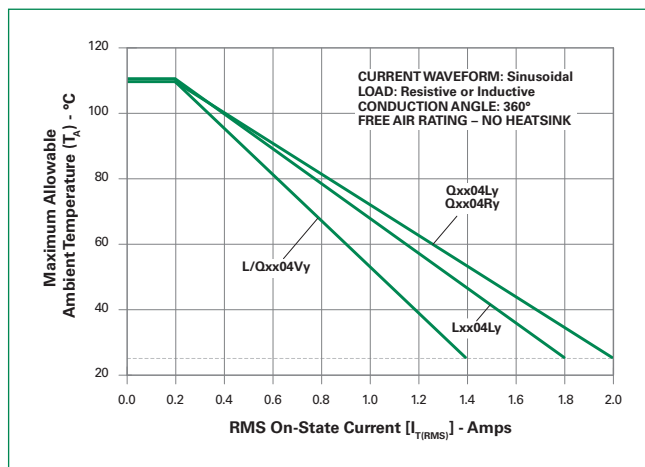

Figure 8: Maximum Allowable Ambient Temperature vs. On-State Current



Note: xx = voltage, y = sensitivity

Figure 9: On-State Current vs. On-State Voltage (Typical)

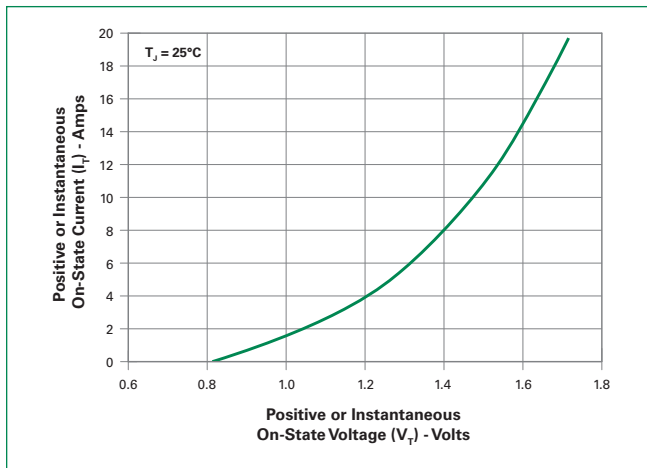
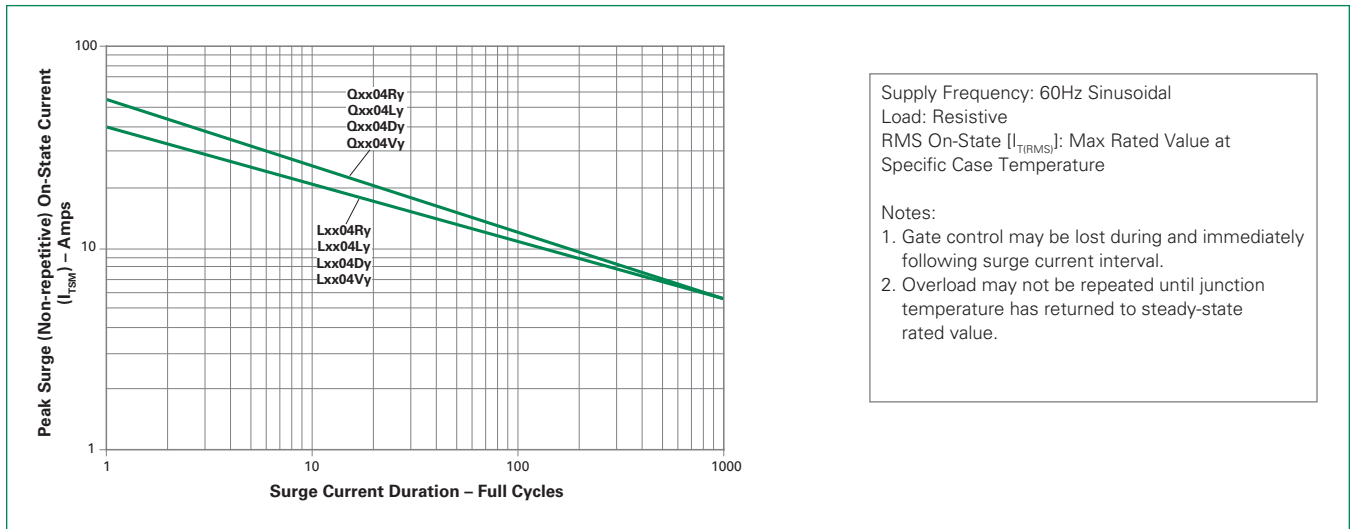

Figure 10: Surge Peak On-State Current vs. Number of Cycles



Note: xx = voltage, y = sensitivity

Soldering Parameters

Reflow Condition		Pb – Free assembly
Pre Heat	- Temperature Min ($T_{s(min)}$)	150°C
	- Temperature Max ($T_{s(max)}$)	200°C
	- Time (min to max) (t_s)	60 – 190 secs
Average ramp up rate (Liquidus Temp (T_L) to peak)		5°C/second max
$T_{s(max)}$ to T_L - Ramp-up Rate		5°C/second max
Reflow	- Temperature (T_L) (Liquidus)	217°C
	- Temperature (t_L)	60 – 150 seconds
Peak Temperature (T_p)		260°C ^{+0/-5}
Time within 5°C of actual peak Temperature (t_p)		20 – 40 seconds
Ramp-down Rate		5°C/second max
Time 25°C to peak Temperature (T_p)		8 minutes Max.
Do not exceed		280°C

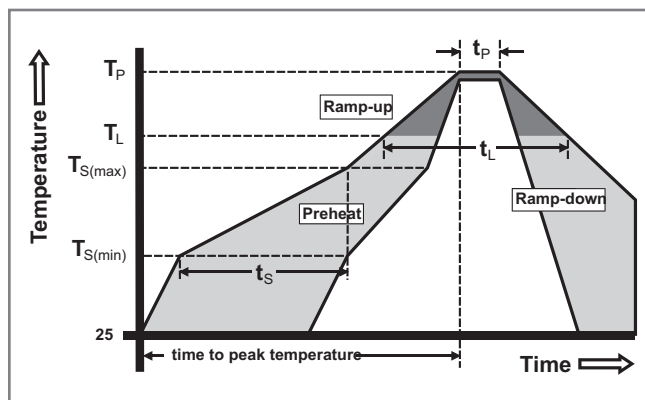

Physical Specifications

Terminal Finish	100% Matte Tin-plated
Body Material	UL recognized epoxy meeting flammability classification 94V-0
Terminal Material	Copper Alloy

Design Considerations

Careful selection of the correct device for the application's operating parameters and environment will go a long way toward extending the operating life of the Thyristor. Good design practice should limit the maximum continuous current through the main terminals to 75% of the device rating. Other ways to ensure long life for a power discrete semiconductor are proper heat sinking and selection of voltage ratings for worst case conditions. Overheating, overvoltage (including dv/dt), and surge currents are the main killers of semiconductors. Correct mounting, soldering, and forming of the leads also help protect against component damage.

Environmental Specifications

Test	Specifications and Conditions
AC Blocking	MIL-STD-750, M-1040, Cond A Applied Peak AC voltage @ 125°C for 1008 hours
Temperature Cycling	MIL-STD-750, M-1051, 100 cycles; -40°C to +150°C; 15-min dwell time
Temperature/Humidity	EIA / JEDEC, JESD22-A101 1008 hours; 320V - DC; 85°C; 85% rel humidity
High Temp Storage	MIL-STD-750, M-1031, 1008 hours; 150°C
Low-Temp Storage	1008 hours; -40°C
Thermal Shock	MIL-STD-750, M-1056 10 cycles; 0°C to 100°C; 5-min dwell time at each temperature; 10 sec (max) transfer time between temperature
Autoclave	EIA / JEDEC, JESD22-A102 168 hours (121°C at 2 ATMs) and 100% R/H
Resistance to Solder Heat	MIL-STD-750 Method 2031
Solderability	ANSI/J-STD-002, category 3, Test A
Lead Bend	MIL-STD-750, M-2036 Cond E

Dimensions — TO-220AB (R-Package) — Non-Isolated Mounting Tab Common with Center Lead

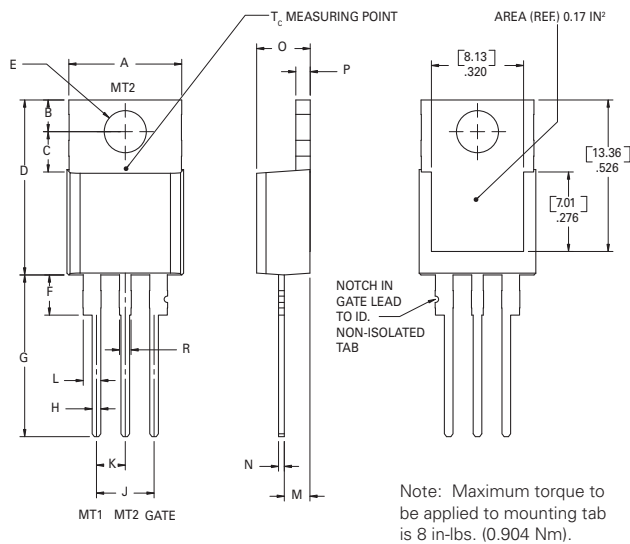

Dimension	Inches		Millimeters	
	Min	Max	Min	Max
A	0.380	0.420	9.65	10.67
B	0.105	0.115	2.67	2.92
C	0.230	0.250	5.84	6.35
D	0.590	0.620	14.99	15.75
E	0.142	0.147	3.61	3.73
F	0.110	0.130	2.79	3.30
G	0.540	0.575	13.72	14.61
H	0.025	0.035	0.64	0.89
J	0.195	0.205	4.95	5.21
K	0.095	0.105	2.41	2.67
L	0.060	0.075	1.52	1.91
M	0.085	0.095	2.16	2.41
N	0.018	0.024	0.46	0.61
O	0.178	0.188	4.52	4.78
P	0.045	0.060	1.14	1.52
R	0.038	0.048	0.97	1.22

4.0A TRIACS

Dimensions — TO-220AB (L-Package) — Isolated Mounting Tab

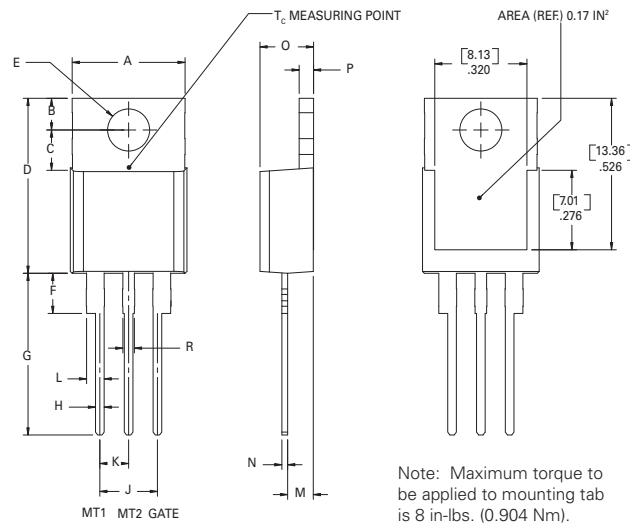

Dimension	Inches		Millimeters	
	Min	Max	Min	Max
A	0.380	0.420	9.65	10.67
B	0.105	0.115	2.67	2.92
C	0.230	0.250	5.84	6.35
D	0.590	0.620	14.99	15.75
E	0.142	0.147	3.61	3.73
F	0.110	0.130	2.79	3.30
G	0.540	0.575	13.72	14.61
H	0.025	0.035	0.64	0.89
J	0.195	0.205	4.95	5.21
K	0.095	0.105	2.41	2.67
L	0.060	0.075	1.52	1.91
M	0.085	0.095	2.16	2.41
N	0.018	0.024	0.46	0.61
O	0.178	0.188	4.52	4.78
P	0.045	0.060	1.14	1.52
R	0.038	0.048	0.97	1.22

Dimensions — TO-251AA (V-Package) — V-PAK Through Hole

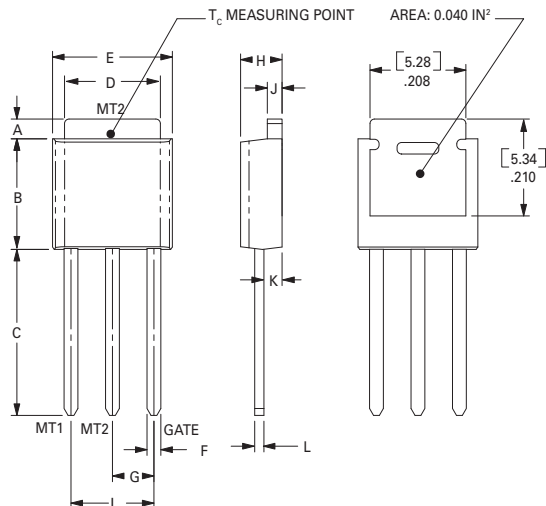

Dimension	Inches		Millimeters	
	Min	Max	Min	Max
A	0.040	0.050	1.02	1.27
B	0.235	0.245	5.97	6.22
C	0.350	0.375	8.89	9.53
D	0.205	0.213	5.21	5.41
E	0.255	0.265	6.48	6.73
F	0.027	0.033	0.69	0.84
G	0.087	0.093	2.21	2.36
H	0.085	0.095	2.16	2.41
I	0.176	0.184	4.47	4.67
J	0.018	0.023	0.46	0.58
K	0.038	0.044	0.97	1.12
L	0.018	0.023	0.46	0.58

Dimensions — TO-252AA (D-Package) — D-PAK Surface Mount

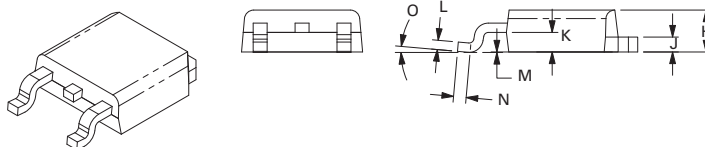
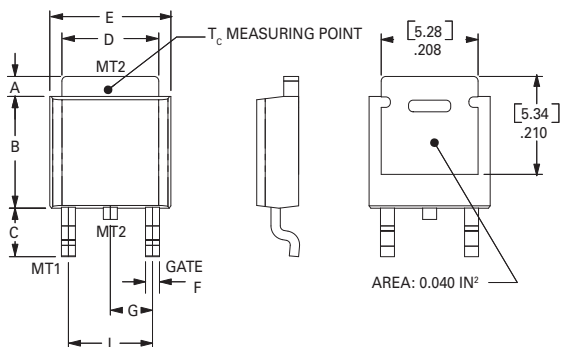

Pad Layout for TO-252AA (D-Package)

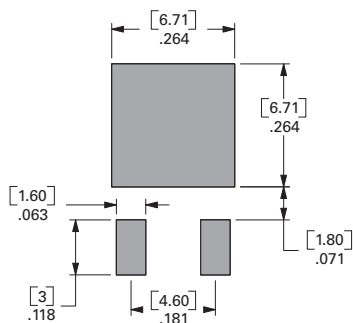

Dimension	Inches		Millimeters	
	Min	Max	Min	Max
A	0.040	0.050	1.02	1.27
B	0.235	0.245	5.97	6.22
C	0.106	0.113	2.69	2.87
D	0.205	0.213	5.21	5.41
E	0.255	0.265	6.48	6.73
F	0.027	0.033	0.69	0.84
G	0.087	0.093	2.21	2.36
H	0.085	0.095	2.16	2.41
I	0.176	0.184	4.47	4.67
J	0.018	0.023	0.46	0.58
K	0.038	0.044	0.97	1.12
L	0.018	0.023	0.46	0.58
M	0.000	0.004	0.00	0.10
N	0.021	0.027	0.53	0.69
O	0°	5°	0°	5°

Product Selector

Part Number	Voltage				Gate Sensitivity Quadrants		Type	Package
	400V	600V	800V	1000V	I – II – III	IV		
Lxx04L3	X	X			3 mA	3 mA	Sensitive Triac	TO-220L
Lxx04D3	X	X			3 mA	3 mA	Sensitive Triac	TO-252 D-PAK
Lxx04R3	X	X			3mA	3mA	Sensitive Triac	TO-220R
Lxx04V3	X	X			3 mA	3 mA	Sensitive Triac	TO-251 V-PAK
Lxx04L5	X	X			5 mA	5 mA	Sensitive Triac	TO-220L
Lxx04D5	X	X			5 mA	5 mA	Sensitive Triac	TO-252 D-PAK
Lxx04R5	X	X			5mA	5mA	Sensitive Triac	TO-220R
Lxx04V5	X	X			5 mA	5 mA	Sensitive Triac	TO-251 V-PAK
Lxx04L6	X	X			5 mA	10 mA	Sensitive Triac	TO-220L
Lxx04D6	X	X			5 mA	10 mA	Sensitive Triac	TO-252 D-PAK
Lxx04R6	X	X			5mA	10mA	Sensitive Triac	TO-220R
Lxx04V6	X	X			5 mA	10 mA	Sensitive Triac	TO-251 V-PAK
Lxx04L8	X	X			10 mA	20 mA	Sensitive Triac	TO-220L
Lxx04D8	X	X			10 mA	20 mA	Sensitive Triac	TO-252 D-PAK
Lxx04R8	X	X			10mA	20mA	Sensitive Triac	TO-220R
Lxx04V8	X	X			10 mA	20 mA	Sensitive Triac	TO-251 V-PAK
Qxx04L3	X	X			10 mA		Standard Triac	TO-220L
Qxx04D3	X	X			10 mA		Standard Triac	TO-252 D-PAK
Qxx04V3	X	X			10 mA		Standard Triac	TO-251 V-PAK
Qxx04R3	X	X			10mA		Standard Triac	TO-220R
Qxx04L4	X	X	X	X	25 mA		Standard Triac	TO-220L
Qxx04D4	X	X	X	X	25 mA		Standard Triac	TO-252 D-PAK
Qxx04R4	X	X	X	X	25mA		Standard Triac	TO-220R
Qxx04V4	X	X	X	X	25 mA		Standard Triac	TO-251 V-PAK

Packing Options

Part Number	Marking	Weight	Packing Mode	Base Quantity
L/Q004L/Ry/TP	L/Qxx04L/Ry	2.2 g	Bulk	500
L/Qxx04LyTP	L/Qxx04Ly	2.2 g	Tube	500
L/Qxx04DyRP	L/Qxx04Dy	0.3 g	Embossed Carrier	2500
L/Qxx04DyTP	L/Qxx04Dy	0.3 g	Tube Pack	750
L/Qxx04VyTP	L/Qxx04Vy	0.4 g	Tube Pack	750

Note: xx = Voltage; y = Sensitivity

TO-252 Embossed Carrier Reel Pack (RP) Specifications

Meets all EIA-481-2 Standards

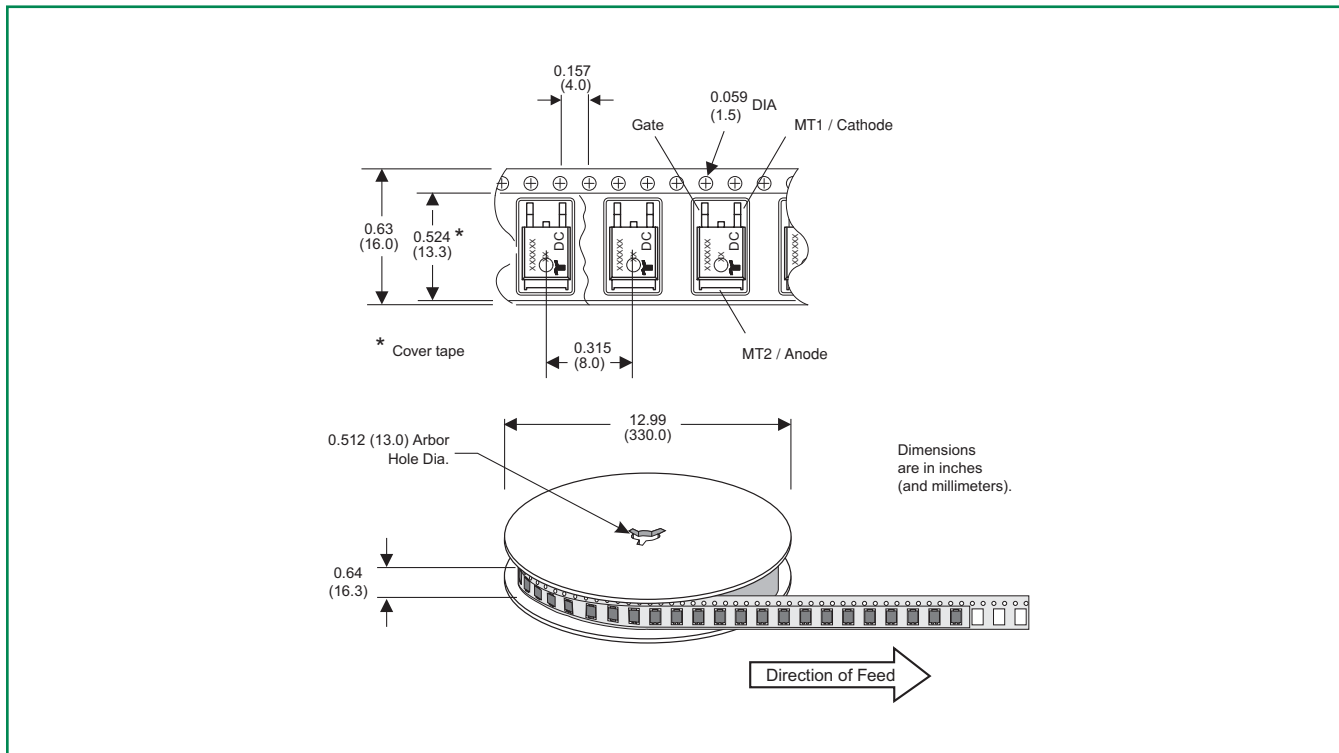

Part Numbering System

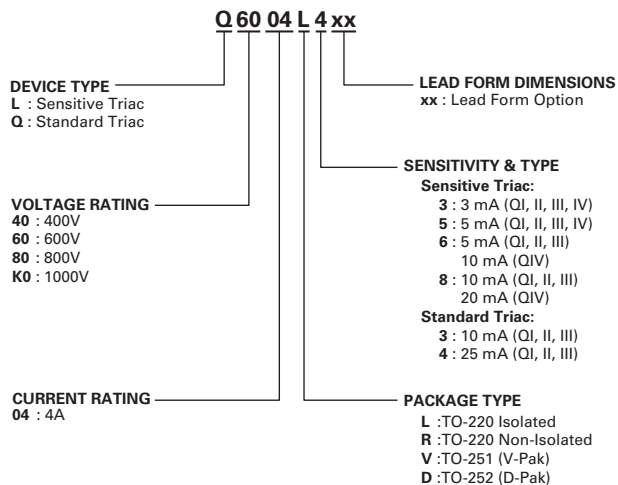

Part Marking System

TO-220 AB
(R & L Packages)

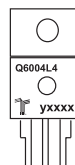

TO-251AA &
TO-252AA
(V and D Packages)

