

Factory Installed Panel Mount

BOURNS®

TRIMPOT® POTENTIOMETER PANEL MOUNTING OPTIONS AND HARDWARE

Many Trimpot® Potentiometers are available for panel mount application.

This product option provides for maximum design flexibility.

To order Trimpot® Potentiometers with panel mount hardware attached by the factory, simply add an "M" or "Z" suffix to the Bourns part number per Table I.

Example:
3006P-1-100Z

To order military Trimpot® Potentiometers with panel mount hardware attached by the factory, order the military part number and add "with panel mount attached."

Example:
RT12C2PRC, with panel mount attached.

To order panel mounting accessories for customer installation, simply use the part number per Table II.

Example:
H83P

NOTE: For complete product specifications, see data sheet for the trimmer model.

Torque - Apply maximum 8 in. lbs. on mounting nut when mounted on panel.

Models RT12/RJ12, 3057/3059

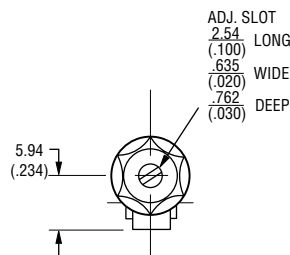
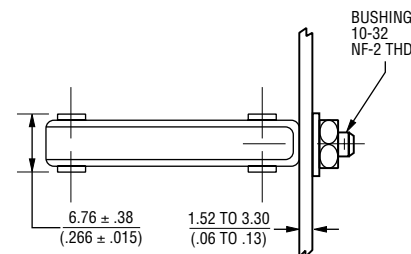
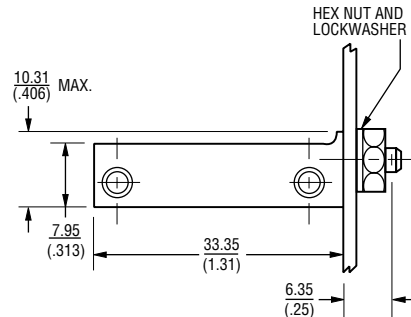

NOTES:

1. PROVIDED WITH LOCKWASHER AND MOUNTING NUT.
2. RECOMMEND PANEL HOLES. #10 DRILL $\frac{.194}{(.008)}$

Models 3005/3006/3009

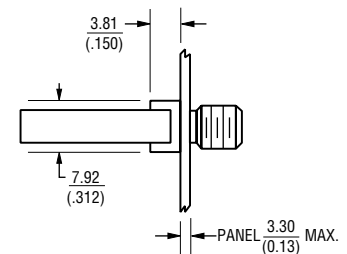
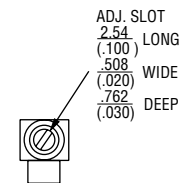
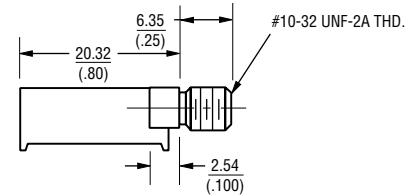

NOTES:

1. PROVIDED WITH LOCKWASHER AND MOUNTING NUT.
2. RECOMMEND PANEL HOLE SIZE #7 DRILL $\frac{.200}{(.008)}$

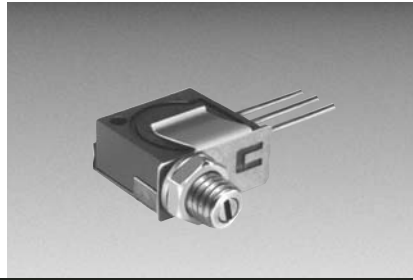
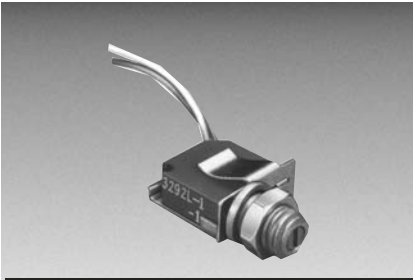

Factory Installed Panel Mount BOURNS®

Models 3292

Models RT22/RTR22/RJ22 3250/3252

Models RT24/RTR24/3290

X, L and W Styles

H and W Styles - 3290 X & W Styles-RT24/RTR24

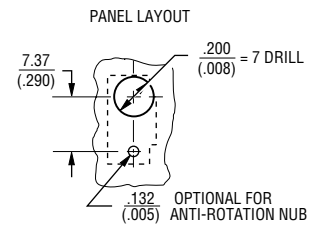
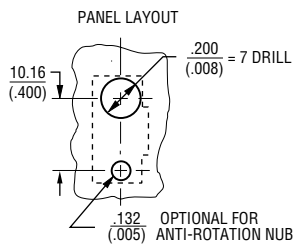
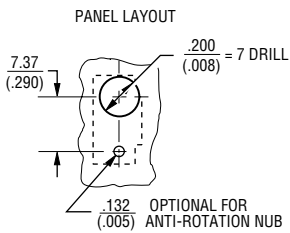
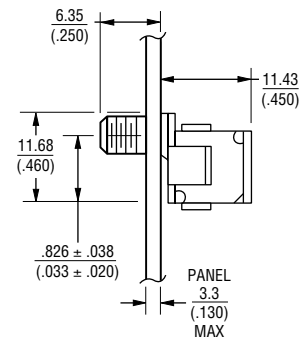
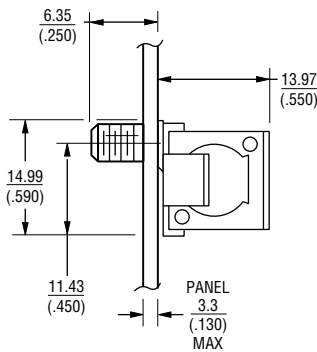
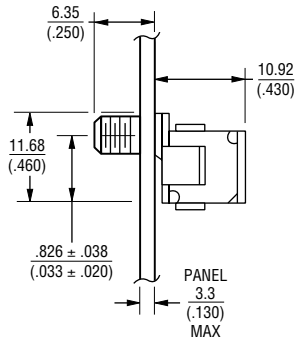
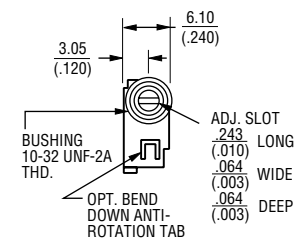
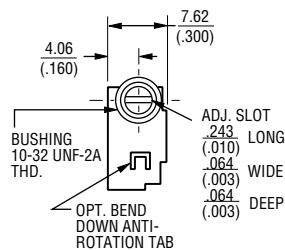
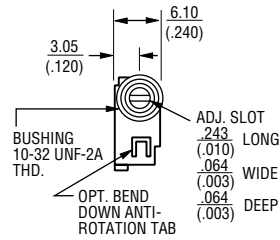

NOTES:
1. PROVIDED WITH LOCKWASHER AND MOUNTING NUT.

NOTES:
1. PROVIDED WITH LOCKWASHER AND MOUNTING NUT.

NOTES:
1. PROVIDED WITH LOCKWASHER AND MOUNTING NUT.

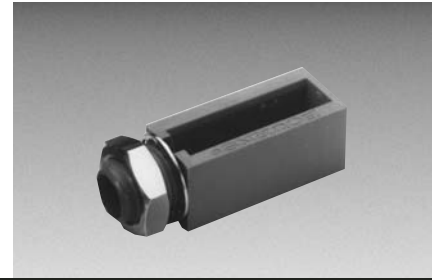
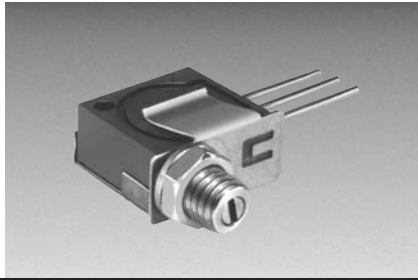
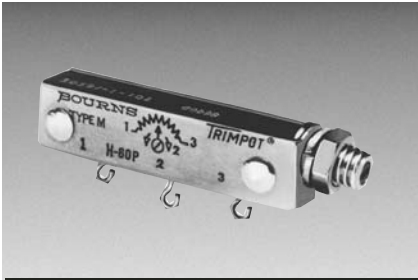

Customer Installed Panel Mount - Unsealed



SEE TABLE II FOR PANEL MOUNT PART NUMBER

H-58P Panel Mount

1-1/4 Inch Rectangular
Multiturn Modules

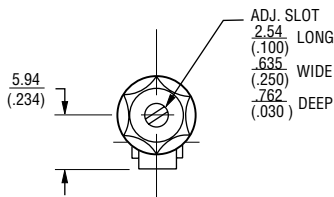
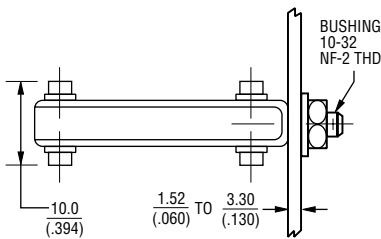
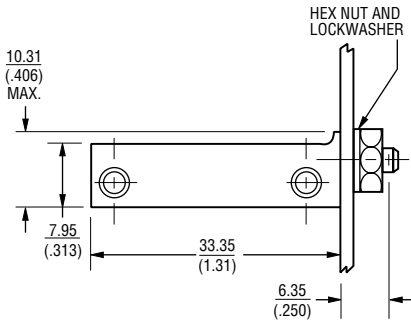

NOTES:

1. PROVIDED WITH LOCKWASHER AND MOUNTING NUT.
2. RECOMMEND PANEL HOLES. #10 DRILL $\frac{.194}{.008}$

*SPECIFY H82 IF PANEL SEAL IS REQUIRED.

H-65P Panel Mount

1/2 Inch Square
Multiturn Models

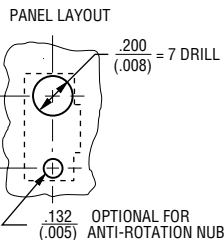
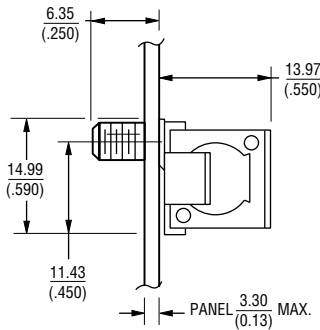
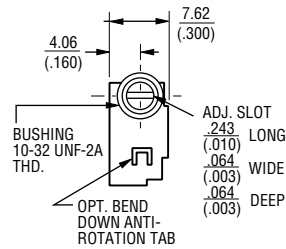

NOTES:

1. PROVIDED WITH LOCKWASHER AND MOUNTING NUT.
2. DRAWINGS SHOWN WITH TRIMMER. ORDER PART SEPARATELY

H-83P Panel Mount

Adapter for Models 3005 AND 3006

The H-83P Adapter is used with Models 3005 and 3006. Order separately and simply snap fit the trimmer in the plastic case. The H-83P with lock-washer and mounting nut is available in 50-piece lots.

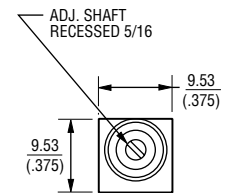
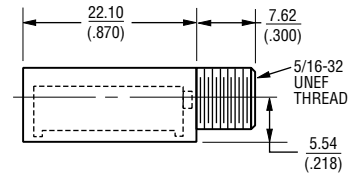

NOTES:

1. DRAWINGS SHOWN WITH TRIMMER. ORDER PART SEPARATELY

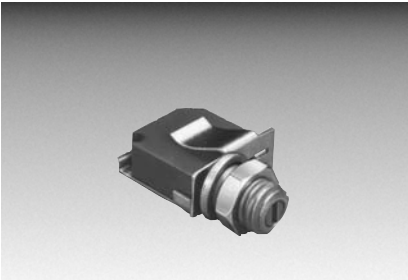

Customer Installed Panel Mount **BOURNS®**

H-114P/115P/116P Panel Mount

3/8 Inch Square Multiturn Models

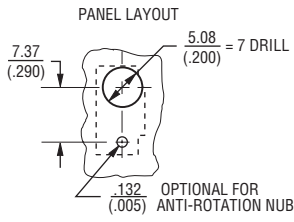
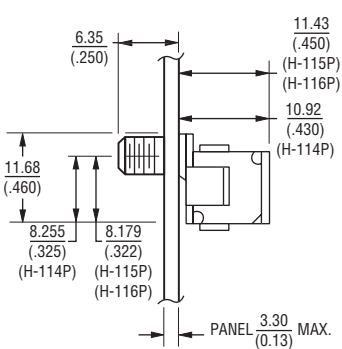
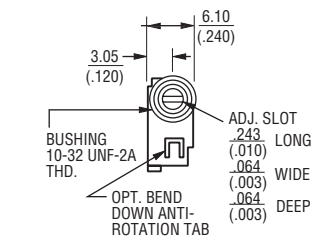

- Notes:**
1. Provided with lockwasher and mounting nut.
 2. Drawings shown with trimmer. Order part separately.

H-117P Panel Mount

3/8 Inch Square Multiturn Models

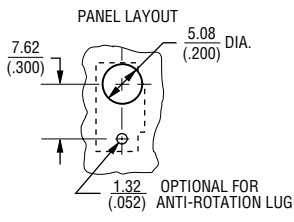
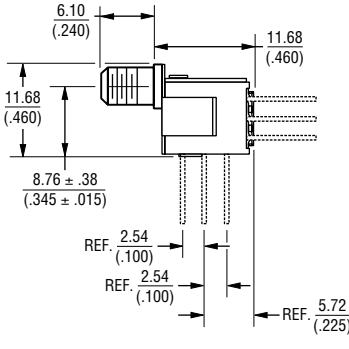
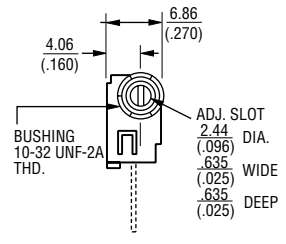

- Notes:**
1. Provided with lockwasher and mounting nut.
 2. Drawings shown with trimmer. Order part separately.

TABLE I
FACTORY INSTALLED
PANEL MOUNTS

STANDARD P/N	P/N WITH PANEL MOUNT
3005P-1-(RC)	3005P-1-(RC) Z
3006P,Y, or W-1-(RC)	3006P,Y, or W-1-(RC) Z
3009P or Y-1-(RC)	3009P or Y-1-(RC) Z
3057L,J,P, or Y-1-(RC)	3057L,J,P, or Y-1-(RC) M
3059L,J,P, or Y-1-(RC)	3059L,J,P, or Y-1-(RC) M
3250L or W-1-(RC)	3250L or W-1-(RC) M
3252L or W-1-(RC)	3252L or W-1-(RC) M
3290 H or W-1-(RC)	3290H or W-1-(RC) M
3292L,W, or X-1-(RC)	3292L,W, or X-1-(RC) M
3296W or X-1-(RC)	3296W or X-1-(RC) M

TABLE II
RETRO-FIT PANEL MOUNTS FOR
INSTALLATION BY CUSTOMER

STANDARD P/N	ORDER PANEL MOUNT P/N
3005P-1-(RC)	H-83P
3006P,Y, or W-1-(RC)	H-83P
3057L,J,P, or Y-1-(RC)	H-58P* SCREW ASSY.
3059L,J,P, or Y-1-(RC)	H-58P* SCREW ASSY.
3250L, W, X-(RC)	H-65P-1*
3252L or W-1-(RC)	H-65P-3*
3252X-1-(RC)	H-65P-5*
3290 H or W-1-(RC)	H-114P*
3292L-1-(RC)	H-115P*
3292W OR X-1-(RC)	H-116P*
RT12P,Y,L	H-58P* SCREW ASSY.
RJ12P,Y	H-58P* SCREW ASSY.
RT22L,W, X,	
RTR22L,W, X	H-65P-1*
RJ22L,W	H-65P-3*
RJ22X	H-65P-5*
RT24W /	
RTR24W OR X	H-114P*
RJR24W OR X	H-117P*

*Specify H-82 if panel seal is required.

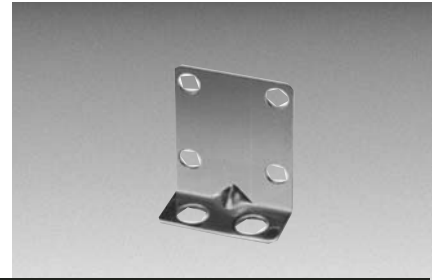
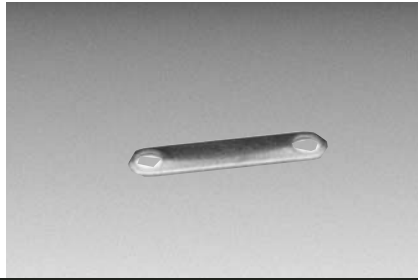
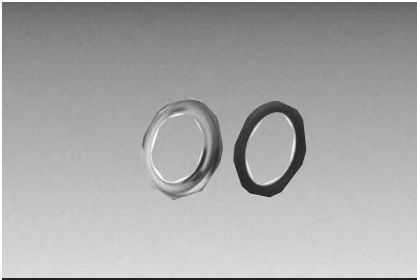

Hardware For Special Mounting Applications **BOURNS®**

H-82 Panel Seal

For all panel mounts with size 10-32 bushings.

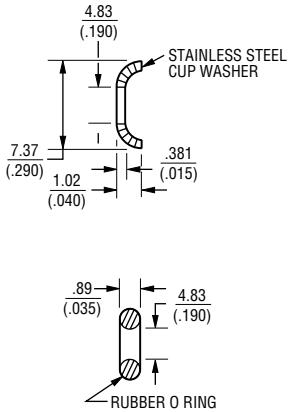

To be used with the following to provide panel seal:

- H-58P
- H-65P-1
- H-65P-3
- H-65P-5
- H-114P
- H-115P
- H-116P
- H-117P

H-25/H-28 Stacking Straps

Models 3250, 3252 (H-25) and 3292 (H-28).

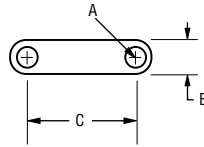

DIMENSIONS	H-25	H-28
A	$\frac{.236}{(.093)}$	$\frac{.178}{(.070)}$
B	$\frac{.363}{(.143)}$	$\frac{.318}{(.125)}$
C	$\frac{1.321}{(.520)}$	$\frac{1.064}{(.419)}$
THICKNESS	.51 (.02)	

H-26S Side Bracket

Models 3250 and 3252
This hardware is available for special mounting applications.

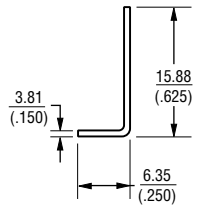
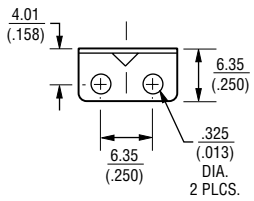
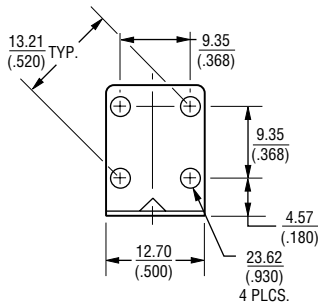

Specifications are subject to change without notice. Customers should verify actual device performance in their specific applications.