

# HW-300A

HW-300Aは、DIP形状InSb高感度ホール素子です。  
標準はバルク供給となります。(500pcs./Pack)

注意 弊社製品のご検討にあたっては本カタログの表紙裏の「重要注意事項」を  
良くお読みください。

Shipped in bulk(500pcs per pack)

Notice : It is requested to read and accept "IMPORTANT NOTICE"  
written on the back of the front cover of this catalogue.

## ●最大定格 Absolute Maximum Ratings

項目 Item	記号 Symbol		定格 Limit	単位 Unit
最大制御電流 Max. Input Current	$I_c$	40°C 定電流駆動 Const. Current Drive	20	mA
動作温度 Operating Temp. Range	Topr.		-40 ~ +110	°C
保存温度 Storage Temp. Range	Tstg.		-40 ~ +125	°C

注) 制限抵抗がない場合は、最大入力電圧の範囲以内でご使用下さい。

## ●電気的特性 (測定温度 25°C) Electrical Characteristics ( $T_a=25^\circ\text{C}$ )

項目 Item	記号 Symbol	測定条件 Conditions	最小 Min.	標準 Typ.	最大 Max.	単位 Unit
ホール出力電圧 Output Hall Voltage	$V_H$	定電圧駆動 Const. Voltage Drive B=50mT, $V_C=1\text{V}$	168		320	mV
入力抵抗 Input Resistance	$R_{in}$	B=0mT, $I_C=0.1\text{mA}$	240		550	$\Omega$
出力抵抗 Output Resistance	$R_{out}$	B=0mT, $I_C=0.1\text{mA}$	240		550	$\Omega$
不平衡電圧 Offset Voltage	$V_{os}(V_u)$	B=0mT, $V_C=1\text{V}$	-7		+7	mV
出力電圧の温度係数 Temp. Coefficient of $V_H$	$\alpha V_H$	20°C基準、0~40°C間の平均 Average on 0~40°C B=50mT, $I_C=5\text{mA}$		-1.8		%/°C
入力抵抗の温度係数 Temp. Coefficient of $R_{in}$	$\alpha R_{in}$	20°C基準、0~40°C間の平均 Average on 0~40°C B=0mT, $I_C=0.1\text{mA}$		-1.8		%/°C
絶縁抵抗 Dielectric Strength		100V D.C	1.0			M $\Omega$

Notes : 1.  $V_H = V_{HM} - V_{os}(V_u)$  (VHM:meter indication)

$$2. \alpha V_H = \frac{1}{V_H(T_1)} \times \frac{V_H(T_3) - V_H(T_2)}{(T_3 - T_2)} \times 100$$

$$3. \alpha R_{in} = \frac{1}{R_{in}(T_1)} \times \frac{R_{in}(T_3) - R_{in}(T_2)}{(T_3 - T_2)} \times 100$$

$$T_1 = 20^\circ\text{C}, T_2 = 0^\circ\text{C}, T_3 = 40^\circ\text{C}$$

## ●外形寸法図 Dimensional Drawing (Unit : mm)

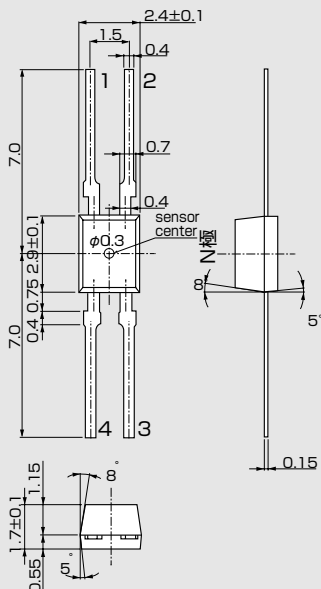

リード接続 Pinning		
入力 Input	1(±)	3(干)
出力 Output	2(干)	4(±)



## ●ホール出力電圧区分とランク表示 Classification of Output Hall Voltage ( $V_H$ )

ランク表示 Rank	ホール出力電圧 $V_H$ [mV]	測定条件 Conditions
C	168 ~ 204	定電圧駆動 B=50mT, $V_C=1\text{V}$ Constant Voltage Drive
D	196 ~ 236	
E	228 ~ 274	
F	266 ~ 320	

注) ランク幅3ランク以上での設計をお願い致します。

Note : When ordering, specify 3-rank or wider range(e.g., C,D,E).

## ●最大入力電流 入出力抵抗 240~550( $\Omega$ ) 静止気中 Input Current Derating Curve

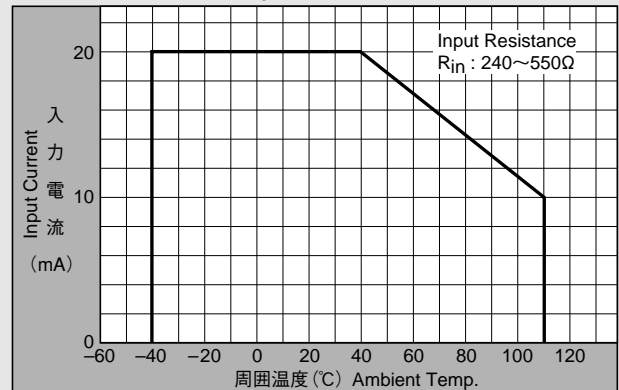

Note :  $R_{in}$  of Hall element decreases rapidly as ambient temperature increases. Ensure compliance with input current derating curve envelope, throughout the operating temperature range.

## ●最大入力電圧 入出力抵抗 240~550( $\Omega$ ) 静止気中 Input Voltage Derating Curve

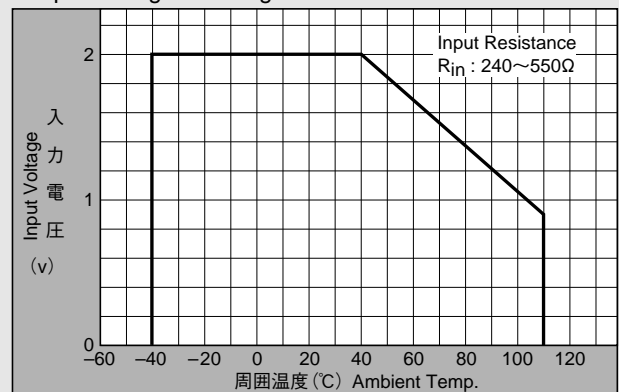

注) 制限抵抗がない場合は、最大入力電圧の範囲以内でご使用下さい。

Note : For constant-voltage drive, stay within this input voltage derating curve envelope.

●製品はある確率で故障する可能性があります。医療機器、自動車、航空宇宙用機器、原子力制御用機器等、その装置・機器の故障や動作不良が、直接または間接を問わず、生命、身体、財産等へ重大な損害を及ぼすことが通常予想されるような極めて高い信頼性を要求される用途に弊社製品を使用される場合は、必ず事前に弊社の書面による同意をおとり下さい。

●Please be aware that AKE products are not intended for use in life support equipment, devices, or systems. Use of AKE products in such applications requires the advance written approval of the appropriate AKE officer.

Certain applications using semiconductor devices may involve potential risks of personal injury, property damage, or loss of life. In order to minimize these risks, adequate design and operating safeguards should be provided by the customer to minimize inherent or procedural hazards. Inclusion of AKE products in such applications is understood to be fully at the risk of the customer using AKE devices or systems.

●特性曲線図 Characteristic Curves

$R_{in}-T$

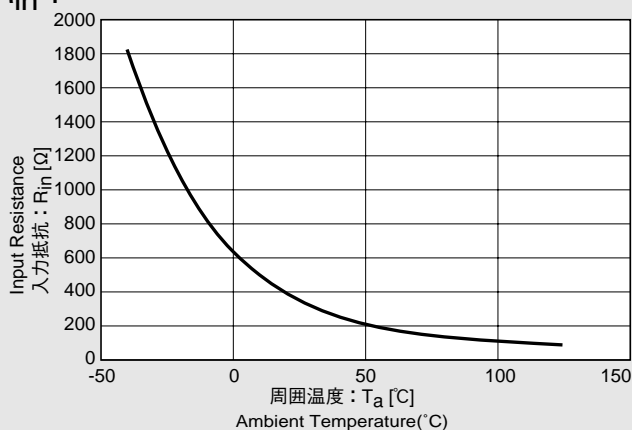

$V_H-B$

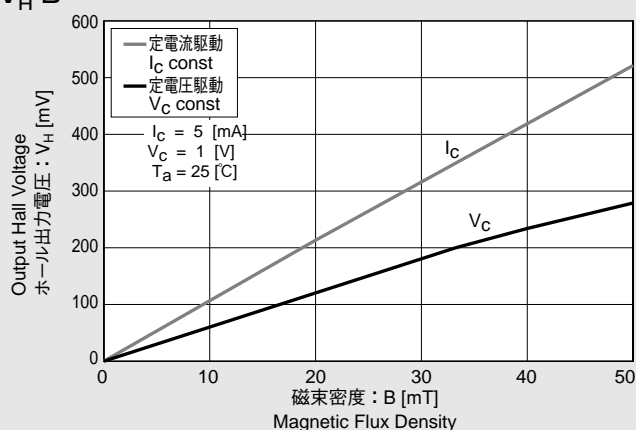

$V_H-T$

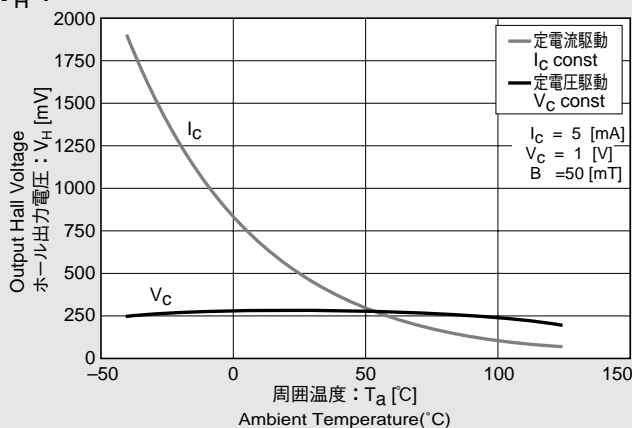

$V_H-V_C, V_H-I_C$

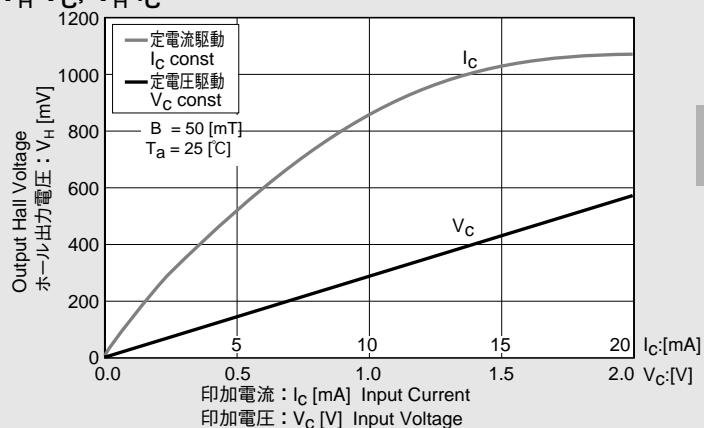

$V_{OS}(V_U)-T$  (参考)

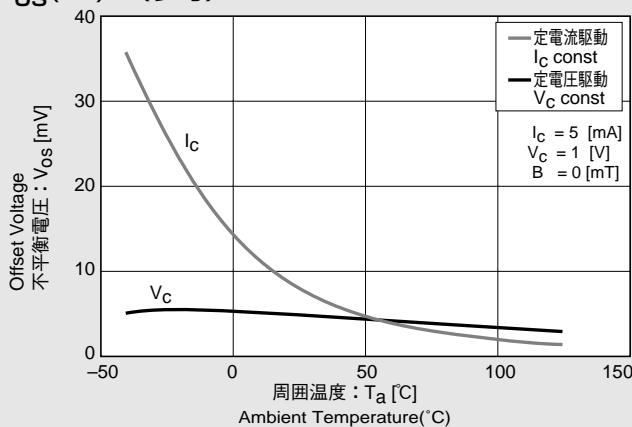

$V_{OS}(V_U)-V_C, V_{OS}(V_U)-I_C$  (参考)

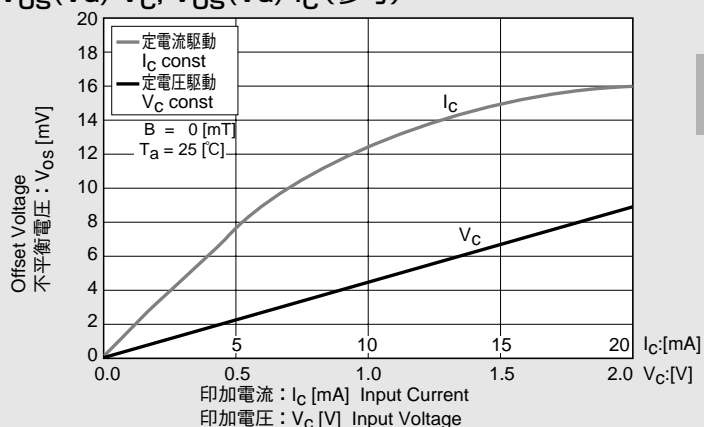

※Magnetic Flux Density  
1[mT]=10[G]

定電圧駆動  $R_{in}=350[\Omega]$ 、 $V_{OS}=4.7[mV]$  [ $V_C=1[V]$ ]の例  
定電流駆動 同上素子  
In This Example :  $R_{in}=350[\Omega]$  ,  $V_{OS}=4.7[mV]$  , [ $V_C=1[V]$ ]