

## CDRHxxxR / CDRHxDxx / CDR / CDRH Series

- Ferrite Shielded
- Up to 8 Amps
- Competitive Prices
- Low Profile to 2.0mm
- Typical Reel Size 1000pcs



The **CDR / CDRH** series of ferrite shielded inductors exhibit excellent current handling characteristics.

### COMPONENT OUTLINE

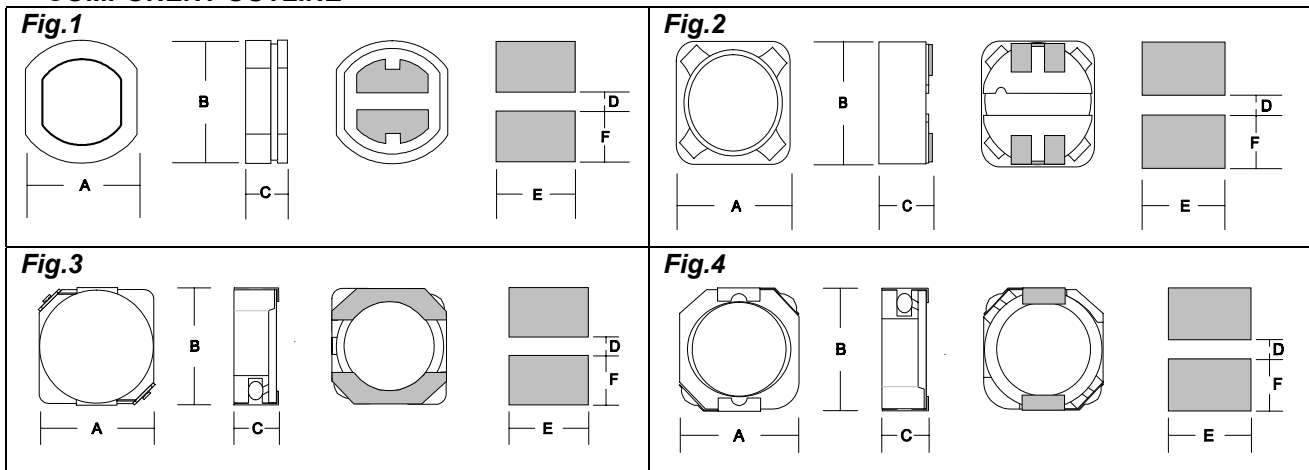

### DIMENSIONS

ECM Type	Inductance Range	Fig.	A (mm)	B	C	D	E	F
CDRH103R	10uH ~ 150uH	4	10.30	10.40	3.00	7.30	3.00	1.70
CDRH104R	1.3uH ~ 330uH	4	10.30	10.40	4.00	7.30	3.00	1.70
CDRH105R	10uH ~ 1mH	4	10.30	10.40	5.00	7.30	3.00	1.70
CDRH4D18	1.0uH ~ 39uH	3	4.70	4.70	2.00	1.50	5.30	1.90
CDRH4D28	1.2uH ~ 180uH	3	4.70	4.70	3.00	1.50	5.30	1.90
CDRH5D18	4.1uH ~ 100uH	3	5.70	5.70	2.00	2.00	6.30	2.15
CDRH5D28	2.6uH ~ 100uH	3	5.70	5.70	3.00	2.00	6.30	2.15
CDRH6D28	3.0uH ~ 100uH	3	6.70	6.70	3.00	2.00	7.30	2.65
CDRH6D38	3.3uH ~ 100uH	3	6.70	6.70	4.00	2.00	7.30	2.65
CDRH73	10uH ~ 1.0mH	2	7.30	7.30	3.20	4.80	2.20	1.60
CDRH74	10uH ~ 1.0mH	2	7.30	7.30	4.50	4.80	2.20	1.60
CDRH125	2.1uH ~ 1.0mH	2	12.00	12.00	6.00	7.00	5.40	2.90
CDRH127	2.4uH ~ 1.0mH	2	12.00	12.00	8.00	7.00	5.40	2.90
CDR63B	10uH ~ 68uH	1	5.60	6.20	3.20	1.70	5.50	2.25
CDR74B	10uH ~ 270uH	1	7.00	7.80	4.50	2.00	7.50	4.00
CDR105B	10uH ~ 470uH	1	9.00	10.00	5.00	2.50	9.50	5.00

# ECM Surface Mount Power Inductors

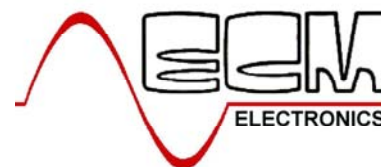

<b>ECM Part</b>	<b>L (<math>\mu</math>H)</b>	<b>Tol %</b>	<b>R<sub>DC</sub> MAX (m<math>\Omega</math>)</b>	<b>I<sub>DC</sub> I<sub>N</sub> (A)</b>
-----------------	----------------------------------	------------------	--	---

## CDRH103R Series

CDRH103R-100	10 @ 100kHz	N	58.1	2.70
CDRH103R-120	12 @ 100kHz	N	72.1	2.25
CDRH103R-150	15 @ 100kHz	N	86.5	2.22
CDRH103R-180	18 @ 100kHz	N	116.1	1.90
CDRH103R-220	22 @ 100kHz	N	145.4	1.78
CDRH103R-270	27 @ 100kHz	N	175.9	1.63
CDRH103R-330	33 @ 100kHz	N	213.4	1.16
CDRH103R-390	39 @ 100kHz	N	268.9	1.32
CDRH103R-470	47 @ 100kHz	N	298.6	1.18
CDRH103R-560	56 @ 100kHz	N	335.8	1.10
CDRH103R-680	68 @ 100kHz	N	451.3	1.04
CDRH103R-820	82 @ 100kHz	N	513.8	0.94
CDRH103R-101	100 @ 100kHz	N	700.0	0.84
CDRH103R-121	120 @ 100kHz	N	765.0	0.76
CDRH103R-151	150 @ 100kHz	N	876.3	0.70

## CDRH104R Series

CDRH104R-1R3	1.3 @ 100kHz	N	8.1	10.00
CDRH104R-2R5	2.5 @ 100kHz	N	10	7.50
CDRH104R-3R8	3.8 @ 100kHz	N	13	6.00
CDRH104R-5R2	5.2 @ 100kHz	N	22	5.50
CDRH104R-7R0	7.0 @ 100kHz	N	27	4.80
CDRH104R-100	10 @ 100kHz	N	35	4.40
CDRH104R-150	15 @ 100kHz	N	50	3.60
CDRH104R-220	22 @ 100kHz	N	73	2.90
CDRH104R-330	33 @ 100kHz	N	93	2.30
CDRH104R-470	47 @ 100kHz	N	128	2.10
CDRH104R-680	68 @ 100kHz	N	213	1.50
CDRH104R-101	100 @ 100kHz	N	304	1.35
CDRH104R-151	150 @ 100kHz	N	506	1.15
CDRH104R-221	220 @ 100kHz	N	756	0.92
CDRH104R-331	330 @ 100kHz	N	1090	0.70

## CDRH105R Series

CDRH105R-100	10 @ 100kHz	N	25.8	3.45
CDRH105R-120	12 @ 100kHz	N	32.0	3.40
CDRH105R-150	15 @ 100kHz	N	40.0	2.83
CDRH105R-180	18 @ 100kHz	N	46.0	2.62
CDRH105R-220	22 @ 100kHz	N	58.5	2.44
CDRH105R-270	27 @ 100kHz	N	65.4	2.24
CDRH105R-330	33 @ 100kHz	N	81.4	1.88
CDRH105R-390	39 @ 100kHz	N	103.1	1.70
CDRH105R-470	47 @ 100kHz	N	122.1	1.56
CDRH105R-560	56 @ 100kHz	N	144.8	1.39
CDRH105R-680	68 @ 100kHz	N	193.0	1.36
CDRH105R-820	82 @ 100kHz	N	219.4	1.20
CDRH105R-101	100 @ 100kHz	N	247.0	1.09
CDRH105R-121	120 @ 100kHz	N	298.4	1.00
CDRH105R-151	150 @ 100kHz	N	355.1	0.91
CDRH105R-181	180 @ 100kHz	N	393.4	0.84
CDRH105R-221	220 @ 100kHz	N	483.8	0.75
CDRH105R-271	270 @ 100kHz	N	632.5	0.68
CDRH105R-331	330 @ 100kHz	N	780.0	0.60
CDRH105R-391	390 @ 100kHz	N	957.5	0.57
CDRH105R-471	470 @ 100kHz	N	1220.4	0.50
CDRH105R-561	560 @ 100kHz	N	1352.4	0.47
CDRH105R-681	680 @ 100kHz	N	1519.2	0.43
CDRH105R-821	820 @ 100kHz	N	1694.4	0.39
CDRH105R-102	1000 @ 100kHz	N	1946.4	0.35

ECM Electronics Limited, Penmaen House, Ashington, West Sussex, RH20 3JR, UK  
 Tel: +44(0)1903 892810; Fax: +44(0)1903 892738. Email: sales@ecmelectronics.co.uk

Although we have attempted to accurately reflect the products we market. ECM reserve the right without prior notice to discontinue any product or make design changes we believe necessary.

# ECM Surface Mount Power Inductors

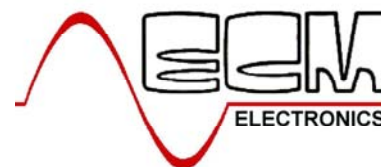

<b>ECM Part</b>	<b>L (<math>\mu</math>H)</b>	<b>Tol %</b>	<b>R<sub>DC</sub> MAX (<math>\Omega</math>)</b>	<b>I<sub>DC</sub> I<sub>N</sub> (A)</b>
-----------------	----------------------------------	------------------	---	---

## CDRH4D18 Series

CDRH4D18-1R0	1.0uH @ 100kHz	N	0.045	1.72
CDRH4D18-2R2	2.2uH @ 100kHz	N	0.075	1.32
CDRH4D18-2R7	2.7uH @ 100kHz	N	0.105	1.28
CDRH4D18-3R3	3.3uH @ 100kHz	N	0.110	1.04
CDRH4D18-3R9	3.9uH @ 100kHz	N	0.155	0.88
CDRH4D18-4R7	4.7uH @ 100kHz	N	0.162	0.84
CDRH4D18-5R6	5.6uH @ 100kHz	N	0.170	0.80
CDRH4D18-6R8	6.8uH @ 100kHz	N	0.200	0.76
CDRH4D18-8R2	8.2uH @ 100kHz	N	0.245	0.68
CDRH4D18-100	10uH @ 100kHz	N	0.200	0.61
CDRH4D18-120	12uH @ 100kHz	N	0.210	0.56
CDRH4D18-150	15uH @ 100kHz	N	0.240	0.50
CDRH4D18-180	18uH @ 100kHz	N	0.338	0.48
CDRH4D18-220	22uH @ 100kHz	N	0.397	0.41
CDRH4D18-270	27uH @ 100kHz	N	0.441	0.35
CDRH4D18-330	33uH @ 100kHz	N	0.694	0.32
CDRH4D18-390	39uH @ 100kHz	N	0.709	0.30

## CDRH4D28 Series

CDRH4D28-1R2	1.2uH @ 100kHz	N	0.0236	2.56
CDRH4D28-1R8	1.8uH @ 100kHz	N	0.0275	2.20
CDRH4D28-2R2	2.2uH @ 100kHz	N	0.0313	2.04
CDRH4D28-2R7	2.7uH @ 100kHz	N	0.0433	1.60
CDRH4D28-3R3	3.3uH @ 100kHz	N	0.0492	1.57
CDRH4D28-3R9	3.9uH @ 100kHz	N	0.0648	1.44
CDRH4D28-4R7	4.7uH @ 100kHz	N	0.0720	1.32
CDRH4D28-5R6	5.6uH @ 100kHz	N	0.1009	1.17
CDRH4D28-6R8	6.8uH @ 100kHz	N	0.1089	1.12
CDRH4D28-8R2	8.2uH @ 100kHz	N	0.1175	1.04
CDRH4D28-100	10uH @ 100kHz	N	0.1283	1.00
CDRH4D28-120	12uH @ 100kHz	N	0.1316	0.84
CDRH4D28-150	15uH @ 100kHz	N	0.1490	0.76
CDRH4D28-180	18uH @ 100kHz	N	0.1660	0.72
CDRH4D28-220	22uH @ 100kHz	N	0.2350	0.70
CDRH4D28-270	27uH @ 100kHz	N	0.2610	0.58
CDRH4D28-330	33uH @ 100kHz	N	0.3780	0.56
CDRH4D28-390	39uH @ 100kHz	N	0.3837	0.50
CDRH4D28-470	47uH @ 100kHz	N	0.5870	0.48
CDRH4D28-560	56uH @ 100kHz	N	0.6245	0.41
CDRH4D28-680	68uH @ 100kHz	N	0.6990	0.35
CDRH4D28-820	82uH @ 100kHz	N	0.9148	0.32
CDRH4D28-101	100uH @ 100kHz	N	1.0200	0.29
CDRH4D28-121	120uH @ 100kHz	N	1.2700	0.27
CDRH4D28-151	150uH @ 100kHz	N	1.3500	0.24
CDRH4D28-181	180uH @ 100kHz	N	1.5400	0.22

## CDRH5D18 Series

CDRH5D18-4R1	4.1 @ 10kHz	N	0.057	1.95
CDRH5D18-5R4	5.4 @ 10kHz	N	0.076	1.60
CDRH5D18-6R2	6.2 @ 10kHz	N	0.096	1.40
CDRH5D18-8R9	8.9 @ 10kHz	N	0.116	1.25
CDRH5D18-100	10 @ 10kHz	N	0.124	1.20
CDRH5D18-120	12 @ 10kHz	N	0.153	1.10
CDRH5D18-150	15 @ 10kHz	N	0.196	0.97
CDRH5D18-180	18 @ 10kHz	N	0.210	0.85
CDRH5D18-220	22 @ 10kHz	N	0.290	0.80
CDRH5D18-270	27 @ 10kHz	N	0.330	0.75
CDRH5D18-330	33 @ 10kHz	N	0.386	0.65
CDRH5D18-390	39 @ 10kHz	N	0.520	0.57

ECM Electronics Limited, Penmaen House, Ashington, West Sussex, RH20 3JR, UK  
 Tel: +44(0)1903 892810; Fax: +44(0)1903 892738. Email: sales@ecmelectronics.co.uk

Although we have attempted to accurately reflect the products we market. ECM reserve the right without prior notice to discontinue any product or make design changes we believe necessary.

# ECM Surface Mount Power Inductors

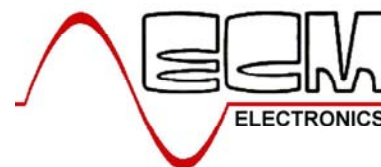

<b>ECM Part</b>	<b>L (<math>\mu</math>H)</b>	<b>Tol %</b>	<b>R<sub>DC</sub> MAX (<math>\Omega</math>)</b>	<b>I<sub>DC</sub> I<sub>N</sub> (A)</b>
-----------------	----------------------------------	------------------	---	---

## CDRH5D18 Series continued...

CDRH5D18-470	47 @ 10kHz	N	0.595	0.54
CDRH5D18-560	56 @ 10kHz	N	0.665	0.50
CDRH5D18-680	68 @ 10kHz	N	0.840	0.43
CDRH5D18-820	82 @ 10kHz	N	0.978	0.41
CDRH5D18-101	100 @ 10kHz	N	1.200	0.36

## CDRH5D28 Series

CDRH5D28-2R6	2.6uH @ 10kHz	N	0.018	2.60
CDRH5D28-3R0	3.0uH @ 10kHz	N	0.024	2.40
CDRH5D28-4R2	4.2uH @ 10kHz	N	0.031	2.20
CDRH5D28-5R3	5.3uH @ 10kHz	N	0.038	1.90
CDRH5D28-6R2	6.2uH @ 10kHz	N	0.045	1.80
CDRH5D28-8R2	8.2uH @ 10kHz	N	0.053	1.60
CDRH5D28-100	10uH @ 10kHz	N	0.065	1.30
CDRH5D28-120	12uH @ 10kHz	N	0.076	1.20
CDRH5D28-150	15uH @ 10kHz	N	0.103	1.10
CDRH5D28-180	18uH @ 10kHz	N	0.110	1.00
CDRH5D28-220	22uH @ 10kHz	N	0.122	0.90
CDRH5D28-270	27uH @ 10kHz	N	0.175	0.85
CDRH5D28-330	33uH @ 10kHz	N	0.189	0.75
CDRH5D28-390	39uH @ 10kHz	N	0.212	0.70
CDRH5D28-470	47uH @ 10kHz	N	0.260	0.62
CDRH5D28-560	56uH @ 10kHz	N	0.305	0.58
CDRH5D28-680	68uH @ 10kHz	N	0.355	0.52
CDRH5D28-820	82uH @ 10kHz	N	0.463	0.46
CDRH5D28-101	100uH @ 10kHz	N	0.520	0.42

## CDRH6D28 Series

CDRH6D28-3R0	3.0uH @ 10kHz	N	0.024	3.00
CDRH6D28-3R9	3.9uH @ 10kHz	N	0.027	2.60
CDRH6D28-5R0	5.0uH @ 10kHz	N	0.031	2.40
CDRH6D28-6R0	6.0uH @ 10kHz	N	0.035	2.25
CDRH6D28-7R3	7.3uH @ 10kHz	N	0.054	2.10
CDRH6D28-8R6	8.6uH @ 10kHz	N	0.058	1.85
CDRH6D28-100	10uH @ 10kHz	N	0.065	1.70
CDRH6D28-120	12uH @ 10kHz	N	0.070	1.55
CDRH6D28-150	15uH @ 10kHz	N	0.084	1.40
CDRH6D28-180	18uH @ 10kHz	N	0.095	1.32
CDRH6D28-220	22uH @ 10kHz	N	0.128	1.20
CDRH6D28-270	27uH @ 10kHz	N	0.142	1.05
CDRH6D28-330	33uH @ 10kHz	N	0.165	0.97
CDRH6D28-390	39uH @ 10kHz	N	0.210	0.86
CDRH6D28-470	47uH @ 10kHz	N	0.238	0.80
CDRH6D28-560	56uH @ 10kHz	N	0.277	0.73
CDRH6D28-680	68uH @ 10kHz	N	0.304	0.65
CDRH6D28-820	82uH @ 10kHz	N	0.390	0.60
CDRH6D28-101	100uH @ 10kHz	N	0.535	0.54

## CDRH6D38 Series

CDRH6D38-3R3	3.3 @ 10kHz	N	0.020	3.50
CDRH6D38-5R0	5.0 @ 10kHz	N	0.024	2.90
CDRH6D38-6R2	6.2 @ 10kHz	N	0.027	2.50
CDRH6D38-7R4	7.4 @ 10kHz	N	0.031	2.30
CDRH6D38-8R7	8.7 @ 10kHz	N	0.034	2.20
CDRH6D38-100	10 @ 10kHz	N	0.038	2.00
CDRH6D38-120	12 @ 10kHz	N	0.053	1.70
CDRH6D38-150	15 @ 10kHz	N	0.057	1.60
CDRH6D38-180	18 @ 10kHz	N	0.092	1.50
CDRH6D38-220	22 @ 10kHz	N	0.096	1.30

ECM Electronics Limited, Penmaen House, Ashington, West Sussex, RH20 3JR, UK  
Tel: +44(0)1903 892810; Fax: +44(0)1903 892738. Email: sales@ecmelectronics.co.uk

Although we have attempted to accurately reflect the products we market. ECM reserve the right without prior notice to discontinue any product or make design changes we believe necessary.

# ECM Surface Mount Power Inductors

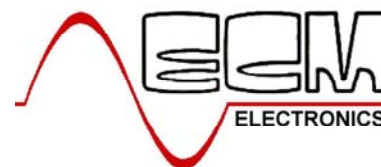

<b>ECM Part</b>	<b>L (<math>\mu</math>H)</b>	<b>Tol %</b>	<b>R<sub>DC</sub> MAX (<math>\Omega</math>)</b>	<b>I<sub>DC</sub> I<sub>N</sub> (A)</b>
-----------------	----------------------------------	------------------	---	---

## CDRH6D38 Series continued...

CDRH6D38-270	27 @ 10kHz	N	0.109	1.20
CDRH6D38-330	33 @ 10kHz	N	0.124	1.10
CDRH6D38-390	39 @ 10kHz	N	0.138	1.00
CDRH6D38-470	47 @ 10kHz	N	0.155	0.95
CDRH6D38-560	56 @ 10kHz	N	0.202	0.85
CDRH6D38-680	68 @ 10kHz	N	0.234	0.75
CDRH6D38-820	82 @ 10kHz	N	0.324	0.70
CDRH6D38-101	100 @ 10kHz	N	0.358	0.65

## CDRH73 Series

CDRH73-100	10 @ 2.52 MHz	L,M	0.07	1.68
CDRH73-120	12 @ 2.52 MHz	L,M	0.10	1.52
CDRH73-150	15 @ 2.52 MHz	L,M	0.13	1.33
CDRH73-180	18 @ 2.52 MHz	L,M	0.14	1.20
CDRH73-220	22 @ 2.52 MHz	L,M	0.19	1.07
CDRH73-270	27 @ 2.52 MHz	L,M	0.21	0.96
CDRH73-330	33 @ 2.52 MHz	L,M	0.24	0.91
CDRH73-390	39 @ 2.52 MHz	L,M	0.32	0.77
CDRH73-470	47 @ 2.52 MHz	L,M	0.36	0.76
CDRH73-560	56 @ 2.52 MHz	L,M	0.47	0.68
CDRH73-680	68 @ 2.52 MHz	L,M	0.52	0.61
CDRH73-820	82 @ 2.52 MHz	L,M	0.69	0.57
CDRH73-101	100 @ 1.0 kHz	L,M	0.79	0.50
CDRH73-121	120 @ 1.0 kHz	L,M	0.89	0.49
CDRH73-151	150 @ 1.0 kHz	L,M	1.27	0.43
CDRH73-181	180 @ 1.0 kHz	L,M	1.45	0.39
CDRH73-221	220 @ 1.0 kHz	L,M	1.65	0.35
CDRH73-271	270 @ 1.0 kHz	L,M	2.31	0.32
CDRH73-331	330 @ 1.0 kHz	L,M	2.62	0.28
CDRH73-391	390 @ 1.0 kHz	L,M	2.94	0.26
CDRH73-471	470 @ 1.0 kHz	L,M	4.18	0.24
CDRH73-561	560 @ 1.0 kHz	L,M	4.67	0.22
CDRH73-681	680 @ 1.0 kHz	L,M	5.73	0.19
CDRH73-821	820 @ 1.0 kHz	L,M	6.54	0.18
CDRH73-102	1000 @ 1.0 kHz	L,M	9.44	0.16

## CDRH74 Series

CDRH74-100	10 @ 2.52 MHz	L,M	0.05	1.84
CDRH74-120	12 @ 2.52 MHz	L,M	0.06	1.71
CDRH74-150	15 @ 2.52 MHz	L,M	0.08	1.47
CDRH74-180	18 @ 2.52 MHz	L,M	0.09	1.31
CDRH74-220	22 @ 2.52 MHz	L,M	0.11	1.23
CDRH74-270	27 @ 2.52 MHz	L,M	0.15	1.12
CDRH74-330	33 @ 2.52 MHz	L,M	0.17	0.96
CDRH74-390	39 @ 2.52 MHz	L,M	0.23	0.91
CDRH74-470	47 @ 2.52 MHz	L,M	0.26	0.88
CDRH74-560	56 @ 2.52 MHz	L,M	0.35	0.75
CDRH74-680	68 @ 2.52 MHz	L,M	0.38	0.69
CDRH74-820	82 @ 2.52 MHz	L,M	0.43	0.61
CDRH74-101	100 @ 1.0 kHz	L,M	0.61	0.60
CDRH74-121	120 @ 1.0 kHz	L,M	0.66	0.52
CDRH74-151	150 @ 1.0 kHz	L,M	0.88	0.46
CDRH74-181	180 @ 1.0 kHz	L,M	0.98	0.42
CDRH74-221	220 @ 1.0 kHz	L,M	1.17	0.36
CDRH74-271	270 @ 1.0 kHz	L,M	1.64	0.34
CDRH74-331	330 @ 1.0 kHz	L,M	1.86	0.32
CDRH74-391	390 @ 1.0 kHz	L,M	2.85	0.29
CDRH74-471	470 @ 1.0 kHz	L,M	3.01	0.26
CDRH74-561	560 @ 1.0 kHz	L,M	3.62	0.23

ECM Electronics Limited, Penmaen House, Ashington, West Sussex, RH20 3JR, UK  
 Tel: +44(0)1903 892810; Fax: +44(0)1903 892738. Email: sales@ecmelectronics.co.uk

Although we have attempted to accurately reflect the products we market. ECM reserve the right without prior notice to discontinue any product or make design changes we believe necessary.

# ECM Surface Mount Power Inductors

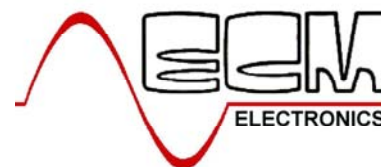

<b>ECM Part</b>	<b>L (<math>\mu</math>H)</b>	<b>Tol %</b>	<b>R<sub>DC</sub> MAX (<math>\Omega</math>)</b>	<b>I<sub>DC</sub> I<sub>N</sub> (A)</b>
-----------------	----------------------------------	------------------	---	---

## CDRH74 Series continued...

CDRH74-681	680 @ 1.0 kHz	L,M	4.63	0.22
CDRH74-821	820 @ 1.0 kHz	L,M	5.20	0.20
CDRH74-102	1000 @ 1.0 kHz	L,M	6.00	0.18

## CDRH125 Series

CDRH125-2R1	2.1 @ 100 kHz	M	0.02	7.00
CDRH125-3R1	3.1 @ 100 kHz	M	0.02	6.00
CDRH125-4R4	4.4 @ 100 kHz	M	0.02	5.00
CDRH125-5R8	5.8 @ 100 kHz	M	0.02	4.40
CDRH125-7R5	7.5 @ 100 kHz	M	0.02	4.20
CDRH125-100	10 @ 1.0 kHz	M	0.03	4.00
CDRH125-150	15 @ 1.0 kHz	M	0.03	3.30
CDRH125-180	18 @ 1.0 kHz	M	0.04	3.00
CDRH125-220	22 @ 1.0 kHz	M	0.04	2.80
CDRH125-330	33 @ 1.0 kHz	L,M	0.06	2.10
CDRH125-390	39 @ 1.0 kHz	L,M	0.07	2.00
CDRH125-470	47 @ 1.0 kHz	L,M	0.08	1.80
CDRH125-560	56 @ 1.0 kHz	L,M	0.11	1.70
CDRH125-680	68 @ 1.0 kHz	L,M	0.12	1.50
CDRH125-820	82 @ 1.0 kHz	L,M	0.14	1.40
CDRH125-101	100 @ 1.0 kHz	L,M	0.16	1.30
CDRH125-121	120 @ 1.0 kHz	L,M	0.17	1.10
CDRH125-151	150 @ 1.0 kHz	L,M	0.23	1.00
CDRH125-181	180 @ 1.0 kHz	L,M	0.29	0.90
CDRH125-221	220 @ 1.0 kHz	L,M	0.40	0.80
CDRH125-271	270 @ 1.0 kHz	L,M	0.46	0.75
CDRH125-331	330 @ 1.0 kHz	L,M	0.51	0.68
CDRH125-471	470 @ 1.0 kHz	L,M	0.77	0.58
CDRH125-561	560 @ 1.0 kHz	L,M	0.86	0.54
CDRH125-681	680 @ 1.0 kHz	L,M	1.20	0.48
CDRH125-821	820 @ 1.0 kHz	L,M	1.34	0.43
CDRH125-102	102 @ 1.0 kHz	L,M	1.53	0.40

## CDRH127 Series

CDRH127-2R4	2.4 @ 100 kHz	M	0.01	8.00
CDRH127-3R5	3.5 @ 100 kHz	M	0.01	7.50
CDRH127-4R7	4.7 @ 100 kHz	M	0.02	6.80
CDRH127-6R1	6.1 @ 100 kHz	M	0.02	6.60
CDRH127-7R6	7.6 @ 100 kHz	M	0.02	5.90
CDRH127-100	10 @ 1.0 kHz	M	0.02	5.40
CDRH127-150	15 @ 1.0 kHz	M	0.03	4.50
CDRH127-180	18 @ 1.0 kHz	M	0.04	3.90
CDRH127-220	22 @ 1.0 kHz	M	0.04	3.60
CDRH127-330	33 @ 1.0 kHz	L,M	0.06	3.00
CDRH127-390	39 @ 1.0 kHz	L,M	0.07	2.75
CDRH127-470	47 @ 1.0 kHz	L,M	0.10	2.50
CDRH127-560	56 @ 1.0 kHz	L,M	0.11	2.35
CDRH127-680	68 @ 1.0 kHz	L,M	0.14	2.10
CDRH127-820	82 @ 1.0 kHz	L,M	0.16	1.95
CDRH127-101	100 @ 1.0 kHz	L,M	0.22	1.70
CDRH127-121	120 @ 1.0 kHz	L,M	0.25	1.60
CDRH127-151	150 @ 1.0 kHz	L,M	0.28	1.42
CDRH127-181	180 @ 1.0 kHz	L,M	0.35	1.30
CDRH127-221	220 @ 1.0 kHz	L,M	0.39	1.16
CDRH127-271	270 @ 1.0 kHz	L,M	0.56	1.06
CDRH127-331	330 @ 1.0 kHz	L,M	0.64	0.95
CDRH127-471	470 @ 1.0 kHz	L,M	0.98	0.79
CDRH127-561	560 @ 1.0 kHz	L,M	1.07	0.73
CDRH127-681	680 @ 1.0 kHz	L,M	1.46	0.67

ECM Electronics Limited, Penmaen House, Ashington, West Sussex, RH20 3JR, UK  
 Tel: +44(0)1903 892810; Fax: +44(0)1903 892738. Email: sales@ecmelectronics.co.uk

Although we have attempted to accurately reflect the products we market. ECM reserve the right without prior notice to discontinue any product or make design changes we believe necessary.



# ECM Surface Mount Power Inductors

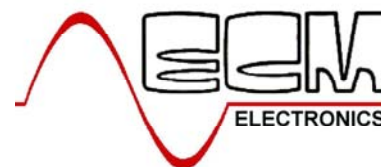

<b>ECM Part</b>	<b>L (<math>\mu</math>H)</b>	<b>Tol %</b>	<b>R<sub>DC</sub> MAX (<math>\Omega</math>)</b>	<b>I<sub>DC</sub> I<sub>N</sub> (A)</b>
-----------------	----------------------------------	------------------	---	---

## CDRH127 Series continued...

CDRH127-821	820 @ 1.0 kHz	L,M	1.64	0.60
CDRH127-102	102 @ 1.0 kHz	L,M	1.82	0.55

## CDR63B Series

CDR63B-100	10 @ 2.52 MHz	M	0.14	1.00
CDR63B-120	12 @ 2.52 MHz	M	0.16	0.94
CDR63B-150	15 @ 2.52 MHz	M	0.18	0.86
CDR63B-220	22 @ 2.52 MHz	M	0.25	0.76
CDR63B-270	27 @ 2.52 MHz	M	0.32	0.64
CDR63B-330	33 @ 2.52 MHz	L,M	0.36	0.61
CDR63B-390	39 @ 2.52 MHz	L,M	0.41	0.53
CDR63B-470	47 @ 2.52 MHz	L,M	0.51	0.50
CDR63B-560	56 @ 2.52 MHz	L,M	0.72	0.46
CDR63B-680	68 @ 2.52 MHz	L,M	0.82	0.42

## CDR74B Series

CDR74B-100	10 @ 2.52 MHz	M	0.07	1.65
CDR74B-120	12 @ 2.52 MHz	M	0.07	1.57
CDR74B-150	15 @ 2.52 MHz	M	0.08	1.39
CDR74B-180	18 @ 2.52 MHz	M	0.10	1.29
CDR74B-220	22 @ 2.52 MHz	M	0.13	1.12
CDR74B-270	27 @ 2.52 MHz	M	0.16	1.06
CDR74B-330	33 @ 2.52 MHz	M	0.18	0.97
CDR74B-390	39 @ 2.52 MHz	M	0.18	0.91
CDR74B-470	47 @ 2.52 MHz	M	0.27	0.80
CDR74B-560	56 @ 2.52 MHz	L,M	0.29	0.76
CDR74B-680	68 @ 2.52 MHz	L,M	0.33	0.68
CDR74B-820	82 @ 2.52 MHz	L,M	0.43	0.62
CDR74B-101	100 @ 1.0 kHz	L,M	0.49	0.55
CDR74B-121	120 @ 1.0 kHz	L,M	0.68	0.49
CDR74B-151	150 @ 1.0 kHz	L,M	0.94	0.44
CDR74B-181	180 @ 1.0 kHz	L,M	1.00	0.40
CDR74B-221	220 @ 1.0 kHz	L,M	1.18	0.36
CDR74B-271	270 @ 1.0 kHz	L,M	1.30	0.33

## CDR105B Series

CDR105B-100	10 @ 2.52 MHz	M	0.06	2.06
CDR105B-120	12 @ 2.52 MHz	M	0.07	1.94
CDR105B-150	15 @ 2.52 MHz	M	0.07	1.72
CDR105B-180	18 @ 2.52 MHz	M	0.08	1.58
CDR105B-220	22 @ 2.52 MHz	M	0.08	1.42
CDR105B-270	27 @ 2.52 MHz	M	0.10	1.32
CDR105B-330	33 @ 2.52 MHz	M	0.11	1.16
CDR105B-390	39 @ 2.52 MHz	M	0.12	1.10
CDR105B-470	47 @ 2.52 MHz	M	0.14	1.00
CDR105B-560	56 @ 2.52 MHz	L,M	0.19	0.93
CDR105B-680	68 @ 2.52 MHz	L,M	0.21	0.85
CDR105B-820	82 @ 2.52 MHz	L,M	0.28	0.79
CDR105B-101	100 @ 1.0 kHz	L,M	0.34	0.72
CDR105B-121	120 @ 1.0 kHz	L,M	0.37	0.63
CDR105B-151	150 @ 1.0 kHz	L,M	0.51	0.55
CDR105B-181	180 @ 1.0 kHz	L,M	0.57	0.50
CDR105B-221	220 @ 1.0 kHz	L,M	0.78	0.47
CDR105B-271	270 @ 1.0 kHz	L,M	0.87	0.41
CDR105B-331	330 @ 1.0 kHz	L,M	1.20	0.37
CDR105B-391	390 @ 1.0 kHz	L,M	1.34	0.35
CDR105B-471	470 @ 1.0 kHz	L,M	1.50	0.33

Tolerance. L=10% M=20% N=30%.

ECM Electronics Limited, Penmaen House, Ashington, West Sussex, RH20 3JR, UK  
Tel: +44(0)1903 892810; Fax: +44(0)1903 892738. Email: sales@ecmelectronics.co.uk

Although we have attempted to accurately reflect the products we market. ECM reserve the right without prior notice to discontinue any product or make design changes we believe necessary.