

### Key-Type Selector Switch

### A165K

Mounting Aperture of 16 mm

- Tool-free installation
- 2-piece construction
- Oil-resistant IP65 models
- Short mounting depth, less than 28.5 mm below panel
- Wide range of switching capacity from general to microload
- Maintained and spring return models available
- UL and CSA approved, VDE (pending)
- Conforms to EN60947-5-1, IEC947-5-1

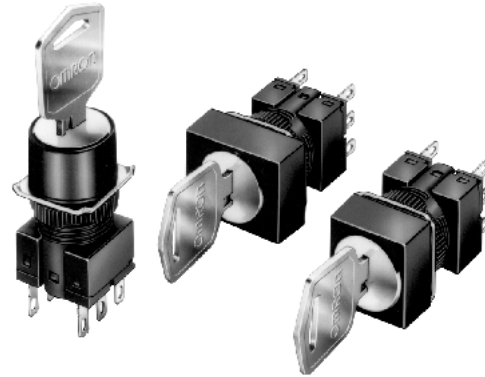

## Ordering Information

### ■ CONSTRUCTION

#### Flange Shape



#### Protective Case and Terminal Type

- **Protective Structure**  
Oil-resistant IP65
- **Terminal Type**  
Solder terminals  
(tab terminals #110)



#### Key Types

- Four key types are available in addition to the standard key.

#### Number of positions and Reset Method

- **2 positions**  
Maintained  
Spring Return
- **3 positions**  
Maintained  
Spring Return

#### Switch Unit Specifications

- **General-purpose Loads**  
125 VAC: 5 A  
250 VAC: 3 A  
30 VDC 3 A  
Minimum applicable load: 1 mA at 5 VDC

■ PART NUMBER NOMENCLATURE A165K ASSEMBLED KEY-TYPE SELECTOR SWITCH (COMPLETE ASSEMBLY)

A165K-J

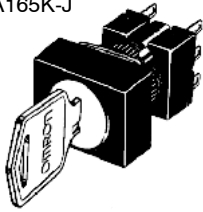

A165K-A

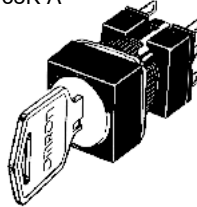

A165K-T

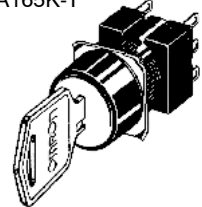

A165K-

1	2	3	4	5
---	---	---	---	---

**1 Flange Shape**

Code	Shape
T	Round
A	Square
J	Rectangular

**4 Key Release Position**

Code	Position
None	All
C	Center
R	Right
L	Left

**2 Number of Positions**

Code	Description
2	2 Position
3	3 Position

**5 Contacts**

Code	Description
1	SPDT
2	DPDT

**3 Reset Method**

Code	Description
M	Maintained
A	Spring returned

**■ PART NUMBERS: NON-ILLUMINATED KEY-TYPE SELECTOR SWITCH (COMPLETE ASSEMBLY)**

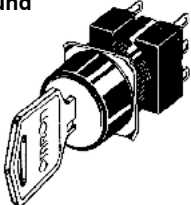
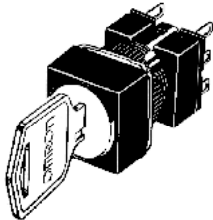
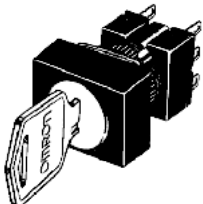

Shape	Number of positions	Contact	Reset method	Key release position	Part number	
<b>Round</b> 	2 positions	SPDT	Maintained	Left	<b>A165K-T2ML-1</b>	
				Right	<b>A165K-T2MR-1</b>	
				All	<b>A165K-T2M-1</b>	
		DPDT	Maintained	Spring return (right)	Left	<b>A165K-T2AL-1</b>
				Left	<b>A165K-T2ML-2</b>	
				Right	<b>A165K-T2MR-2</b>	
	3 positions	DPDT	Maintained	All	<b>A165K-T2M-2</b>	
				Spring return (right)	Left	<b>A165K-T2AL-2</b>
				Center	<b>A165K-T3MC-2</b>	
				Right	<b>A165K-T3MR-2</b>	
<b>Square</b> 	2 positions	SPDT	Maintained	Left	<b>A165K-A2ML-1</b>	
				Right	<b>A165K-A2MR-1</b>	
				All	<b>A165K-A2M-1</b>	
		DPDT	Maintained	Spring return (right)	Left	<b>A165K-A2AL-1</b>
				Left	<b>A165K-A2ML-2</b>	
				Right	<b>A165K-A3MR-2</b>	
3 positions	DPDT	Maintained	All	<b>A165K-A2M-2</b>		
			Spring return (right)	Left	<b>A165K-A2AL-2</b>	
			Center	<b>A165K-A3MC-2</b>		
			Right	<b>A165K-A3MR-2</b>		
<b>Rectangular</b> 	2 positions	SPDT	Maintained	Left	<b>A165K-J2ML-1</b>	
				Right	<b>A165K-J2MR-1</b>	
				All	<b>A165K-J2M-1</b>	
		DPDT	Maintained	Spring return (right)	Left	<b>A165K-J2AL-1</b>
				Left	<b>A165K-J2ML-2</b>	
				Right	<b>A165K-J2MR-2</b>	
	3 positions	DPDT	Maintained	All	<b>A165K-J2M-2</b>	
				Spring return (right)	Left	<b>A165K-J2AL-2</b>
				Center	<b>A165K-J3MC-2</b>	
				Right	<b>A165K-J3MR-2</b>	
				Left	<b>A165K-J3ML-2</b>	
				All	<b>A165K-J3M-2</b>	
				Spring return (both)	Center	<b>A165K-J3AC-2</b>

## Accessories (Order Separately)

### ■ PANEL PLUGS

Shape	Classification	Remarks	Part number
	Rectangular	Used for covering the panel cutouts for future panel expansion.	<b>A3BJ-3003</b>
	Square		<b>A3BA-3003</b>
	Round		<b>A3BT-3003</b>

### ■ TOOLS

Name	Shape	Applicable types					Remarks	Part number
		Pushbutton Switch	Knob-type Selector Switch	Key-type Selector Switch	Emergency Stop Switch	Indicator		
Screw fitting		Yes	Yes	Yes	Yes	Yes	Convenient for ganged installation. Tighten to a torque of 0.39 N • m (5 kgf • cm) min.	<b>A3B-3004</b>
Extractor		Yes	Yes	Yes	Yes	Yes	Convenient for extracting the Switch Unit and Lamps.	<b>A16Z-5080</b>

# Specifications

## ■ APPROVED STANDARDS

### UL, cUL (File No. E41515)

5 A at 125 VAC, 3 A at 250 VAC (general use)

3 A at 30 VDC (resistive)

### EN60947-5-1 (Low Voltage Directive)

## ■ RATINGS

AC resistive load	DC resistive load
3 A, 250 VAC 5 A, 125 VAC	3 A, 30 VDC

Minimum applicable load: 1 mA at 5 VDC

Rated values are obtained from tests conducted under the following conditions according to JIS C4505 and C4520.

1. Load: Resistive load
2. Mounting conditions: No vibration and no shock
3. Temperature: 20°±2°C
4. Operating frequency: 20 times/min

## ■ CONTACT

Name	Contact
SPDT	

## ■ CHARACTERISTICS

Item	Key-type Selector Switch	
Allowable operating frequency	Mechanical	20 operations/min max.
	Electrical	10 operations/min max.
Insulation resistance	100 MΩ min. (at 500 VDC)	
Dielectric strength	1,000 VAC, 50/60 Hz for 1 min between terminals of same polarity 2,000 VAC, 50/60 Hz for 1 min between terminals of different polarity and also between each terminal and ground	
Vibration resistance	Malfuction	10 to 55 Hz, 1.5-mm double amplitude (malfuction within 1 ms)
Shock resistance	Mechanical	500 m/s <sup>2</sup> (50G)
	Malfuction	150 m/s <sup>2</sup> (15G) max. (malfuction within 1 ms)
Life expectancy	Mechanical	250,000 operations min. (life of key: 10,000 operations min.)
	Electrical	100,000 operations min.
Ambient temperature	Operating: -10°C to 55°C (14°F to 131°F) with no icing or condensation Storage: -25°C to 65°C (-13°F to 149°F) with no icing or condensation	
Ambient humidity	Operating: 35% to 85%	
Electric shock protection class	Class II	
Degree of contamination	3 (IEC947-5-1)	
Weight	Approx. 26.5 g (0.93 oz) in the case of a DPDT switch key	

Note: Set and reset constitute one operation.

## ■ OPERATING CHARACTERISTICS

Features	Type	Key-type Selector Switch	
		2 positions	3 positions
Operating force (OF) max.		9.8 N • m (1,000 gf • cm)	
Set position (SP)		90±5°	45±10°

■ OPERATION ANGLE

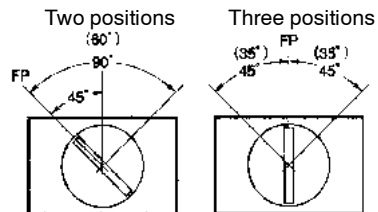

Note: The angle used for automatic reset is shown in parentheses.

■ CONTACTS

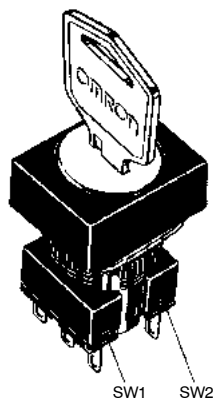

Position	Contact				
	SPDT		DPDT		
	Position	SW	Position	SW1	SW2
2 positions					
3 positions	—				
	—				
	—				

# Dimensions

Unit: mm (inch)

## KEY-TYPE SELECTOR SWITCHES

### Rectangular A165K-J

Solder terminals

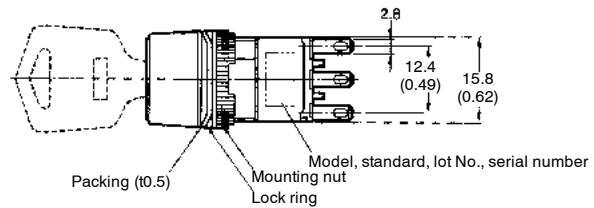
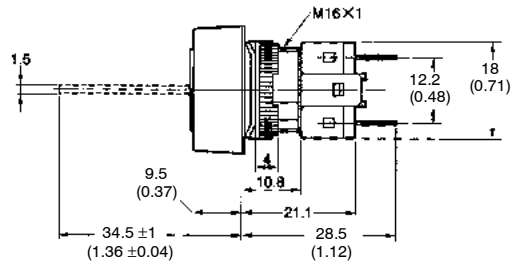
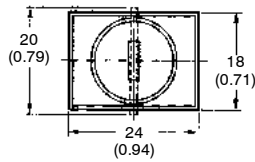
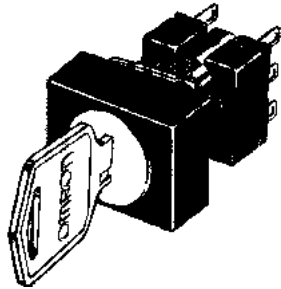

### Square A165K-A

Solder terminals

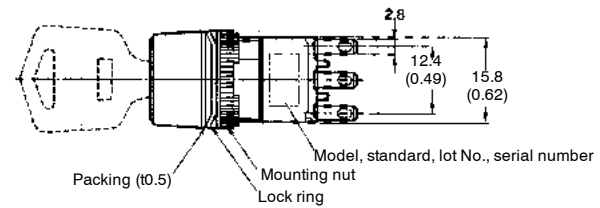
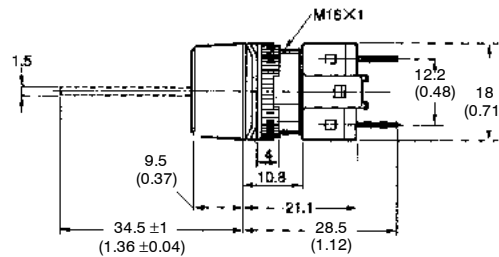
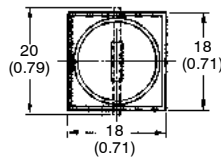
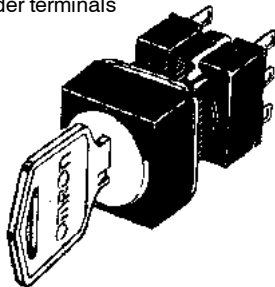

### Round A165K-T

Solder terminals

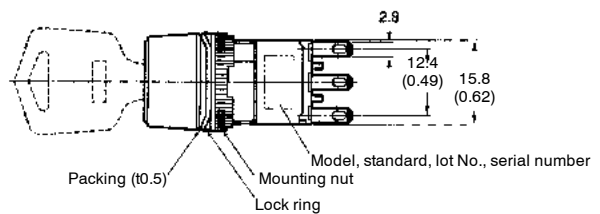
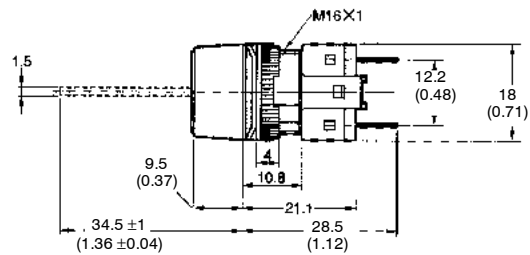
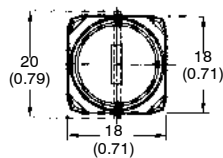
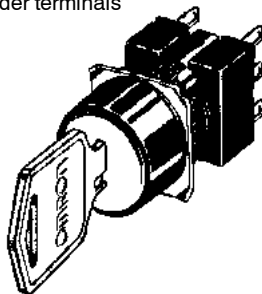

## ■ PANEL CUTOUTS

### Rectangular A165□-J

(Top View)

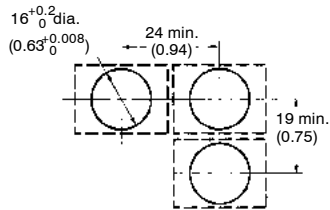

### Square A165□-A Round A165□-T

(Top View)

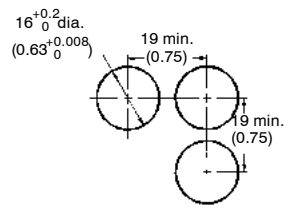

- Note: 1. Make sure the thickness of the mounting panel is between 0.5 and 3.2 mm. If, however, a Switch Guard or Dust Cover is used, the thickness of the mounting panel must be between 0.5 and 2 mm.
2. If the panel is to be finished with coating, etc., make sure that the panel meets the specified dimensions after coating.

## ■ TERMINAL ARRANGEMENT

### SPDT Switches

Dimensions of  
Terminal Holes

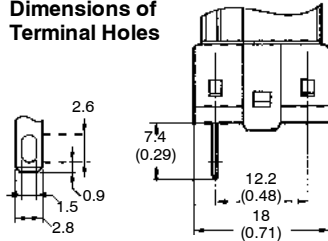

Terminal Arrangement  
(Bottom View)

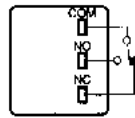

### DPDT Switches

Dimensions of  
Terminal Holes

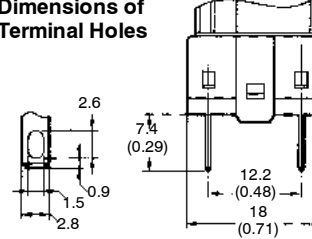

Terminal Arrangement  
(Bottom View)

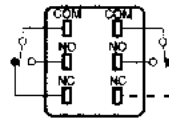

## Installation

For mounting and removal instructions refer to the *Installation* section of the A16 Pushbutton switch.

## ■ FLANGE ROTATION

### A165 Key-type Selector Switch

Fix the Switch screw and rotate the flange in 45° turns.

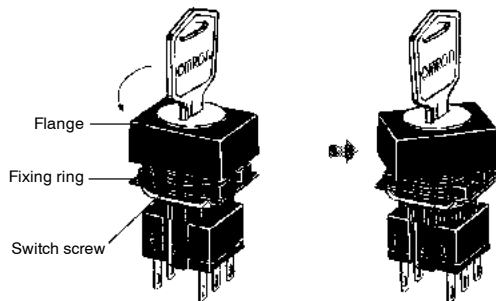



**NOTE: DIMENSIONS SHOWN ARE IN MILLIMETERS. To convert millimeters to inches divide by 25.4.**

---

**OMRON**<sup>®</sup>**OMRON ELECTRONICS LLC**One East Commerce Drive  
Schaumburg, IL 60173**1-800-55-OMRON****OMRON ON-LINE**Global - <http://www.omron.com>  
USA - <http://www.omron.com/oei>  
Canada - <http://www.omron.com/oci>**OMRON CANADA, INC.**885 Milner Avenue  
Scarborough, Ontario M1B 5V8**416-286-6465**