

**Features**

- **Low Voltage Programmable Logic Device**  
Wide Power Supply Range - 3.0 V to 5.5 V  
Ideal for Battery Powered Systems
- **High Speed Operation**  
20 ns max Propagation Delay at Vcc = 3.0 V
- **Full Military, Commercial and Industrial Temperature Ranges**
- **Familiar 22V10 Logic Architecture**
- **Low Power 3-Volt CMOS Operation**

	AT22LV10L	AT22LV10	
Temp	Com./Mil.	Com./Mil.	
Icc (mA)	4 / 5	35 / 45	Vcc = 3.6 V

- **CMOS and TTL Compatible Inputs and Outputs**  
10 µA Leakage Maximum
- **Reprogrammable - Tested 100% for Programmability**
- **High Reliability CMOS Technology**  
2000 V ESD Protection  
200 mA Latchup Immunity
- **Dual-In-Line and Surface Mount Packages**

**Logic Diagram**

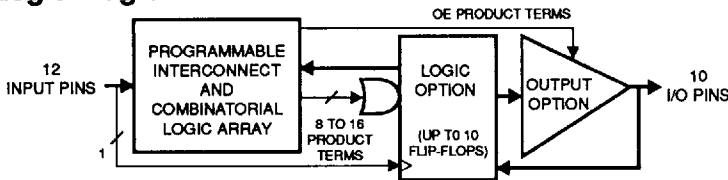

**Description**

The AT22LV10 and AT22LV10L are low voltage compatible CMOS high performance Programmable Logic Devices (PLDs). Speeds down to 20 ns and power dissipation as low as 14.4 mW are offered. All speed ranges are specified over the 3.0 V to 5.5 V range. All pins offer a low ±10 µA leakage.

The AT22LV10L provides the optimum low power CMOS PLD solution, with low DC power (1 mA typical at Vcc = 3.3 V) and full CMOS output levels. The AT22LV10L significantly reduces total system power, allowing battery powered operation.

Full CMOS output levels help reduce power in many other system components.

The AT22LV10 and AT22LV10L logic architectures are identical to the familiar 22V10. Each output is allocated from eight to 16 product terms, which allows highly complex logic functions to be realized.

Two additional product terms are included to provide synchronous preset and asynchronous reset. These terms are common to all ten registers. All registers are automatically cleared upon power up.

Register preload simplifies testing. A security fuse prevents unauthorized copying of programmed fuse patterns.

**Pin Configurations**

Pin Name	Function
CLK/IN	Clock and Logic Input
IN	Logic Inputs
I/O	Bidirectional Buffers
*	No Internal Connection
VCC	3.0 V to 5.5 V Supply

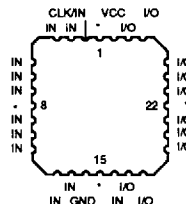
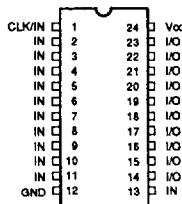

## Absolute Maximum Ratings\*

Temperature Under Bias.....	-55°C to +125°C
Storage Temperature.....	-65°C to +150°C
Voltage on Any Pin with Respect to Ground.....	-2.0 V to +7.0 V <sup>(1)</sup>
Voltage on Input Pins with Respect to Ground During Programming.....	-2.0 V to +14.0 V <sup>(1)</sup>
Programming Voltage with Respect to Ground.....	-2.0 V to +14.0 V <sup>(1)</sup>
Integrated UV Erase Dose.....	7258 W-sec/cm <sup>2</sup>

\*NOTICE: Stresses beyond those listed under "Absolute Maximum Ratings" may cause permanent damage to the device. This is a stress rating only and functional operation of the device at these or any other conditions beyond those indicated in the operational sections of this specification is not implied. Exposure to absolute maximum rating conditions for extended periods may affect device reliability.

Note:

1. Minimum voltage is -0.6 V dc which may undershoot to -2.0 V for pulses of less than 20 ns. Maximum pin voltage is  $V_{CC}+0.75$  V dc which may overshoot to  $V_{CC}+2.0$  V for pulses of less than 20 ns.

## Logic Options

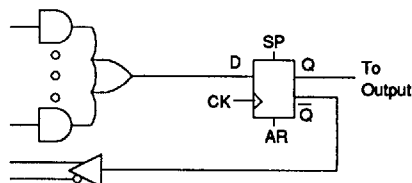
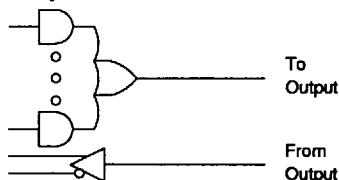

## Output Options

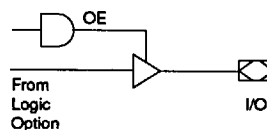
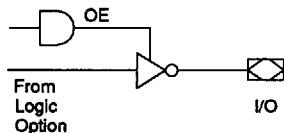

## D.C. and A.C. Operating Conditions

	Commercial AT22LV10/L -20, -25, -30	Industrial AT22LV10/L -20, -25, -30	Military AT22LV10/L -25, -30, -35
Operating Temperature (Case)	0°C - 70°C	-40°C - 85°C	-55°C - 125°C
V <sub>CC</sub> Power Supply	3.0 V to 5.5 V	3.0 V to 5.5 V	3.0 V to 5.5 V

## Operating Modes

Mode	24-Pin DIP	1	5	8	13	I/Os	V <sub>CC</sub> (24)
	28-Pin JLCC	2	6	10	16	I/Os	V <sub>CC</sub> (28)
"PLD"	X <sup>(1)</sup>	X	X	X	X	I/O	3.0 V to 5.5 V
Program	V <sub>PP</sub>	X/V <sub>H</sub> <sup>(2)</sup>	X	V <sub>PP</sub>	D <sub>IN</sub>	6 V	
PGM Verify	V <sub>PP</sub>	X/V <sub>H</sub>	X	V <sub>IL</sub>	D <sub>OUT</sub>	6 V	
PGM Inhibit	V <sub>PP</sub>	X/V <sub>H</sub>	X	V <sub>IH</sub>	High Z	6 V	
Preload	X	X	V <sub>H</sub>	X	D <sub>IN</sub>	3.0 V to 5.5 V	

Notes: 1. X can be V<sub>IL</sub> or V<sub>IH</sub>.

2. V<sub>H</sub> = 11.0 V to 14.0 V

## D.C. Characteristics

Symbol	Parameter	Condition	Min	Typ	Max	Units	
I <sub>LI</sub>	Input Load Current	V <sub>IN</sub> = -0.1 V to V <sub>CC</sub> +1 V			10	μA	
I <sub>LO</sub>	Output Leakage Current	V <sub>OUT</sub> = -0.1 V to V <sub>CC</sub> +0.1 V			10	μA	
I <sub>CC</sub>	Power Supply Current	V <sub>CC</sub> = 3.6 V / 5.5 V, V <sub>IN</sub> = GND, Outputs Open	AT22LV10	Com.	20/50	35/90	mA
				Ind., Mil.	20/50	45/100	mA
		AT22LV10L <sup>(2)</sup>	Com.	1/2	4/12	mA	
			Ind., Mil.	1/2	5/15	mA	
I <sub>CC2</sub>	Clocked Power Supply Current	f = 1 MHz, V <sub>CC</sub> = 3.6 V / 5.5 V, Outputs Open	AT22LV10L <sup>(2)</sup>	Com.	3/5	7/15	mA
				Ind., Mil.	3/5	10/20	mA
I <sub>OS</sub> <sup>(1)</sup>	Output Short Circuit Current	V <sub>OUT</sub> = 0.5 V			-90	mA	
V <sub>IL1</sub>	Input Low Voltage	4.5 V ≤ V <sub>CC</sub> ≤ 5.5 V	-0.6		0.8	V	
V <sub>IL2</sub>	Input Low Voltage	3.0 V ≤ V <sub>CC</sub> < 4.5 V	-0.6		0.6	V	
V <sub>IH</sub>	Input High Voltage		2.0		V <sub>CC</sub> +0.75	V	
V <sub>OL</sub>	Output Low Voltage V <sub>IN</sub> = V <sub>IH</sub> or V <sub>IL</sub>	V <sub>CC</sub> = 3.0 V	Com., Ind./Mil.	I <sub>OL</sub> = 8 mA / 6 mA		0.5	V
		V <sub>CC</sub> = 4.5 V	Com., Ind./Mil.	I <sub>OL</sub> = 16 mA / 12 mA		0.5	V
		V <sub>CC</sub> = 3.0 V	Com., Ind./Mil.	I <sub>OL</sub> = 6 mA / 4 mA		0.35	V
V <sub>OH</sub>	Output High Voltage	V <sub>IN</sub> = V <sub>IH</sub> or V <sub>IL</sub> , V <sub>CC</sub> = 3.0 V / 4.5 V	I <sub>OH</sub> = -100 μA		V <sub>CC</sub> -0.3		V
			I <sub>OH</sub> = -0.4 mA / -4.0 mA		2.4		V

Notes: 1. Not more than one output at a time should be shorted. Duration of short circuit test should not exceed 30 sec.  
 2. See I<sub>CC</sub> vs. Frequency curves in the back of this data sheet.

## A.C. Characteristics for the AT22LV10

Symbol	Parameter	AT22LV10-20			AT22LV10-25			AT22LV10-30			Units
		Min	Typ	Max	Min	Typ	Max	Min	Typ	Max	
t <sub>PD</sub>	Input or Feedback to Non-Registered Output		12	20		15	25		20	30	ns
t <sub>EA</sub>	Input to Output Enable			20		15	25		20	30	ns
t <sub>ER</sub>	Input to Output Disable			20		15	25		20	30	ns
t <sub>CF</sub>	Clock to Feedback	0	4	9	0	5	9	0	6	10	ns
t <sub>CO</sub>	Clock to Output	0	8	14	0	10	17	0	12	20	ns
t <sub>S</sub>	Input or Feedback Setup Time	10	6		12	7		15	8		ns
t <sub>H</sub>	Hold Time	0			0			0			ns
t <sub>P</sub>	Clock Period	10			12			14			ns
t <sub>W</sub>	Clock Width	5			6			7			ns
F <sub>MAX</sub>	External Feedback 1/(t <sub>S</sub> +t <sub>CO</sub> )			41.6			34.5			28.5	MHz
	Internal Feedback 1/(t <sub>S</sub> + t <sub>CF</sub> )			52.6			47.6			40.0	MHz
	No Feedback 1/(t <sub>P</sub> )			100.0			83.3			71.4	MHz
t <sub>AW</sub>	Asynchronous Reset Width	20	12		25	15		30	18		ns
t <sub>AR</sub>	Asynchronous Reset, Synchronous Preset, Recovery Time	20	12		25	15		30	18		ns
t <sub>AP</sub>	Asynchronous Reset to Registered Output Reset		15	25		18	28		20	30	ns





## A.C. Waveforms <sup>(1)</sup>

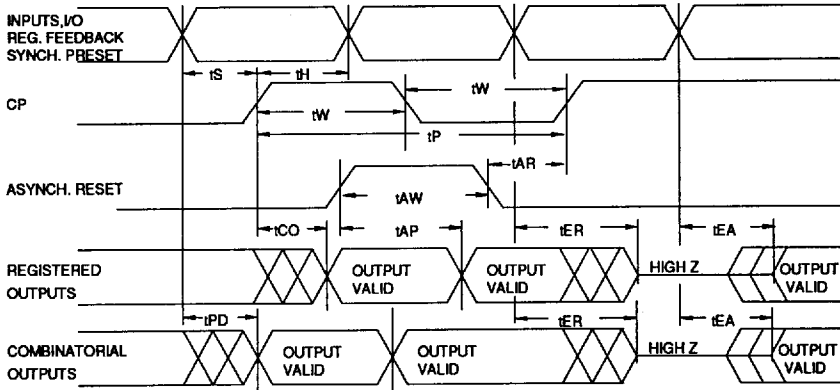

Note: 1. Timing measurement reference is 1.5 V. Input AC driving levels are 0.0 V and 3.0 V, unless otherwise specified.

## A.C. Characteristics for the AT22LV10L

Symbol	Parameter	AT22LV10L-25			AT22LV10L-30			AT22LV10L-35			Units
		Min	Typ	Max	Min	Typ	Max	Min	Typ	Max	
$t_{PD}$	Input or Feedback to Non-Registered Output		15	25		20	30		25	35	ns
$t_{EA}$	Input to Output Enable		15	25		20	30		25	35	ns
$t_{ER}$	Input to Output Disable		15	25		20	30		25	35	ns
$t_{CF}$	Clock to Feedback	0	5	9	0	6	10		7	11	ns
$t_{CO}$	Clock to Output	0	10	14	0	12	17		15	20	ns
$t_{SF}$	Feedback Setup Time	12	7		15	10		18	12		ns
$t_S$	Input Setup Time	17	15		20	15		22	15		ns
$t_H$	Hold Time	0			0			0			ns
$t_P$	Clock Period	12			14			16			ns
$t_W$	Clock Width	6			7			8			ns
$f_{MAX}$	External Feedback $1/(t_S+t_{CO})$			32.2			27.0			23.8	MHz
	Internal Feedback $1/(t_{SF} + t_{CF})$			47.6			40.0			34.4	MHz
	No Feedback $1/(t_P)$			83.3			71.4			62.5	MHz
$t_{AW}$	Asynchronous Reset Width	25	15		30	18		35	20		ns
$t_{AR}$	Asynchronous Reset Recovery Time	25	15		30	18		35	20		ns
$t_{AP}$	Asynchronous Reset to Registered Output Reset		18	28		20	30		22	35	ns

## Input Test Waveforms and Measurement Levels

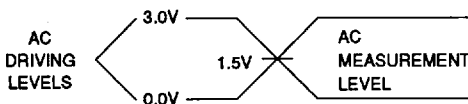

$t_R, t_F < 5$  ns (10% to 90%)

## Output Test Loads:

### Commercial

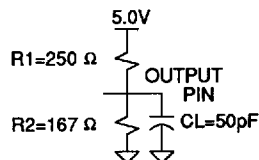

### Military

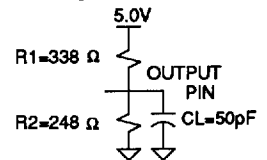

Functional Logic Diagram AT22LV10/L

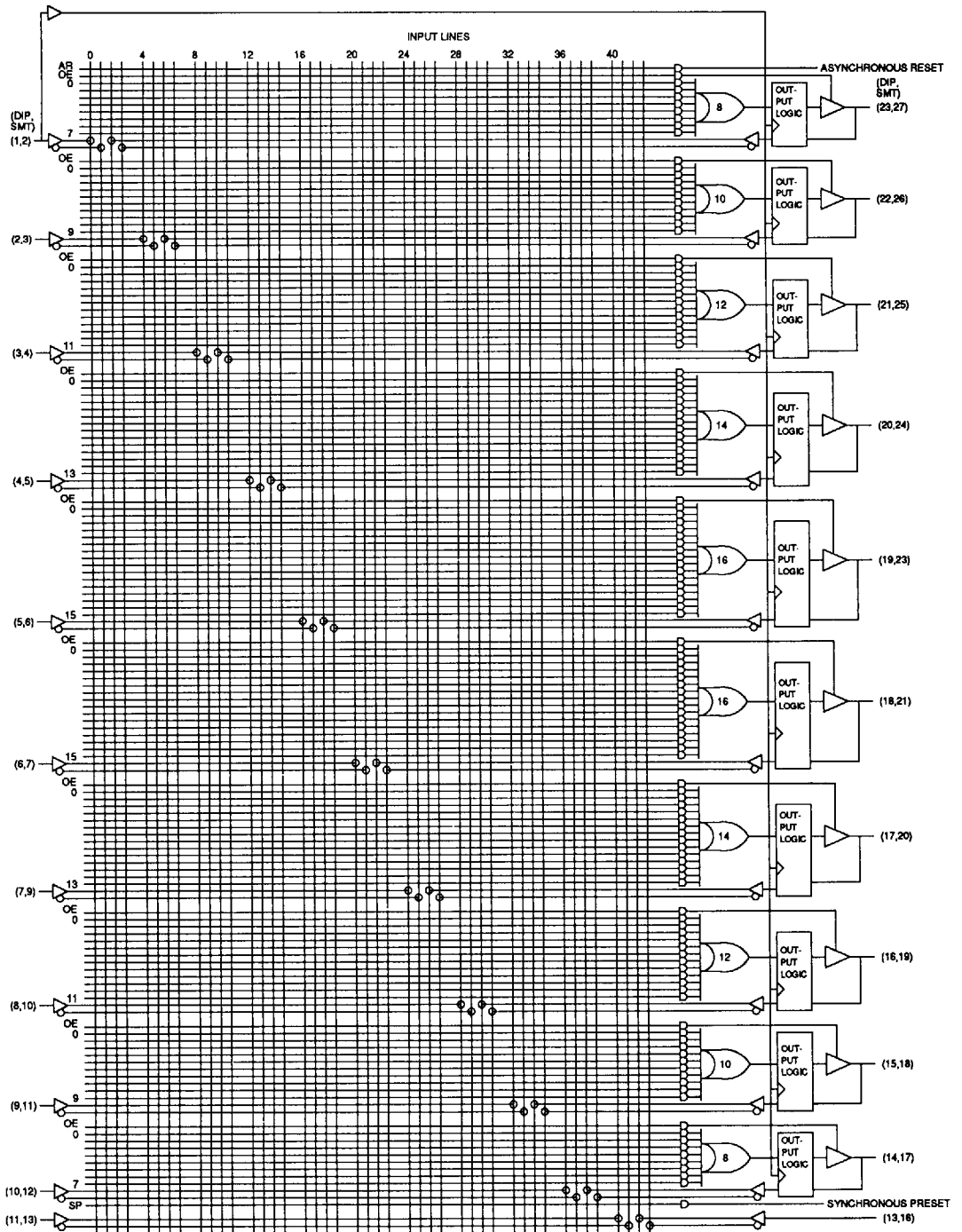

1



## Preload of Registered Outputs

The registers in the AT22LV10 and AT22LV10L are provided with circuitry to allow loading of each register asynchronously with either a high or a low. This feature will simplify testing since any state can be forced into the registers to control test sequencing. A  $V_{IH}$  level on the I/O pin will force the register high; a  $V_{IL}$  will force it low, independent of the polarity bit (C0) setting. The preload state is entered by placing an 11-V to 14-V signal on pin 8 on DIPs, and pin 10 on SMPs. When the clock pin is pulsed high, the data on the I/O pins is placed into the ten registers.

Level forced on registered output pin during preload cycle	Register state after cycle
$V_{IH}$	High
$V_{IL}$	Low

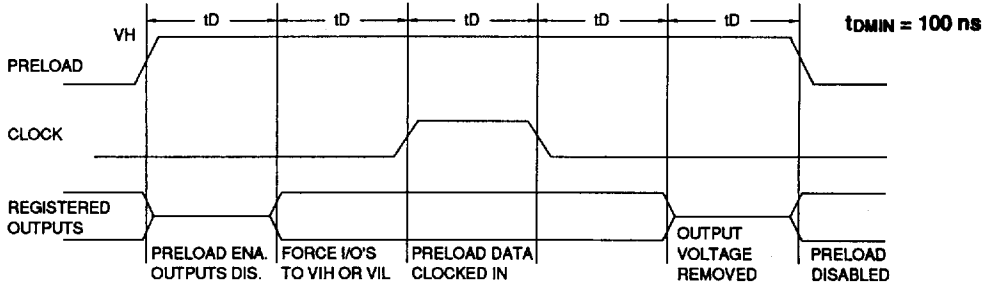

## Power Up Reset

The registers in the AT22LV10 and AT22LV10L are designed to reset during power up. At a point delayed slightly from  $V_{CC}$  crossing 2.5 V, all registers will be reset to the low state. The output state will depend on the polarity of the output buffer.

This feature is critical for state machine initialization. However, due to the asynchronous nature of reset and the uncertainty of how  $V_{CC}$  actually rises in the system, the following conditions are required:

- 1) The  $V_{CC}$  rise must be monotonic,
- 2) After reset occurs, all input and feedback setup times must be met before driving the clock pin high, and
- 3) The clock must remain stable during  $t_{PR}$ .

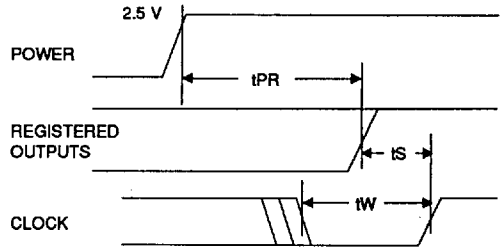

Parameter	Description	Min	Typ	Max	Units
$t_{PR}$	Power-Up Reset Time		600	1000	ns

## Pin Capacitance ( $f = 1 \text{ MHz}$ , $T = 25^\circ\text{C}$ )<sup>(1)</sup>

	Typ	Max	Units	Conditions
$C_{IN}$	5	8	pF	$V_{IN} = 0 \text{ V}$
$C_{OUT}$	6	8	pF	$V_{OUT} = 0 \text{ V}$

Note: 1. Typical values for nominal supply voltage. This parameter is only sampled and is not 100% tested.

## Erasure Characteristics

The entire fuse array of an AT22LV10 or AT22LV10L is erased after exposure to ultraviolet light at a wavelength of 2537 Å. Complete erasure is assured after a minimum of 20 minutes exposure using 12,000  $\mu\text{W}/\text{cm}^2$  intensity lamps spaced one inch away from the chip. Minimum erase time for lamps at other in-

tensity ratings can be calculated from the minimum integrated erasure dose of 15  $\text{W}\cdot\text{sec}/\text{cm}^2$ . To prevent unintentional erasure, an opaque label is recommended to cover the clear window on any UV erasable PLD which will be subjected to continuous fluorescent indoor lighting or sunlight.

## SUPPLY CURRENT vs. INPUT FREQUENCY

AT22LV10 (TA = 25°C)

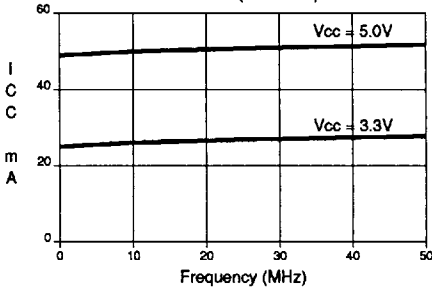

## SUPPLY CURRENT vs. INPUT FREQUENCY

AT22LV10L (TA = 25°C)

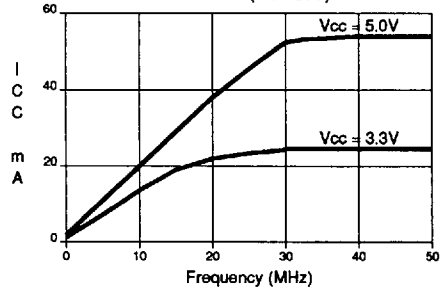

## NORMALIZED SUPPLY CURRENT vs. SUPPLY VOLTAGE

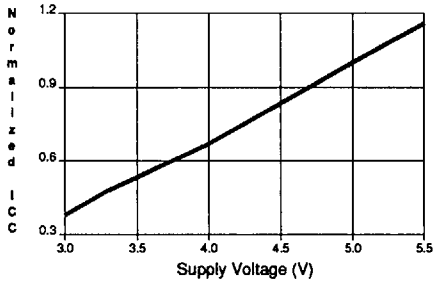

## NORMALIZED ICC vs. AMBIENT TEMP.

f = 30 MHz

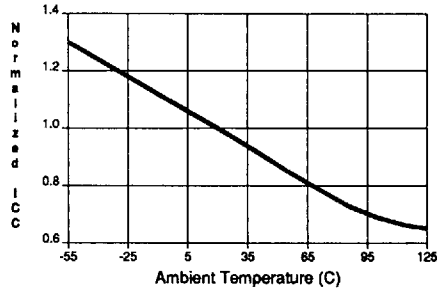

## OUTPUT SINK CURRENT vs. SUPPLY VOLTAGE (TA = 25°C)

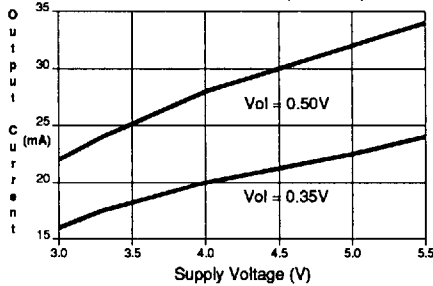

## OUTPUT SINK CURRENT vs. OUTPUT VOLTAGE (TA = 25°C)

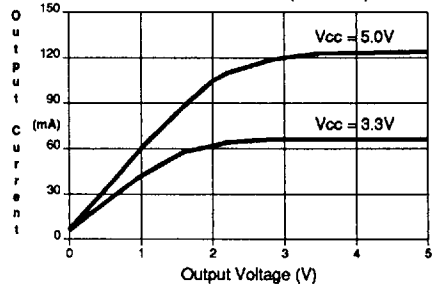

## OUTPUT SOURCE CURRENT vs. SUPPLY VOLTAGE (VOH = 2.4V TA = 25°C)

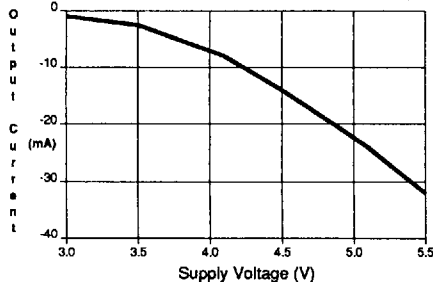

## OUTPUT SOURCE CURRENT vs. OUTPUT VOLTAGE (TA = 25°C)

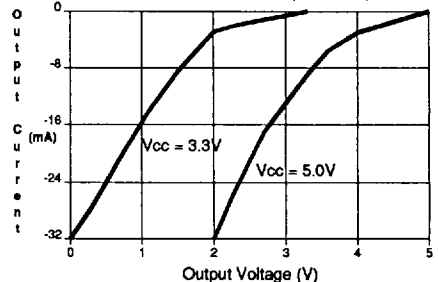

**NORMALIZED TPD  
vs. SUPPLY VOLTAGE**

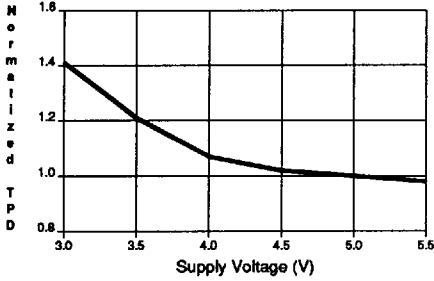

**NORMALIZED TPD  
vs. TEMPERATURE**

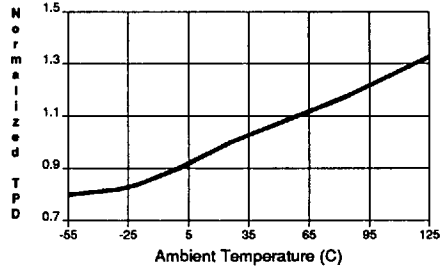

**NORMALIZED TCO  
vs. SUPPLY VOLTAGE**

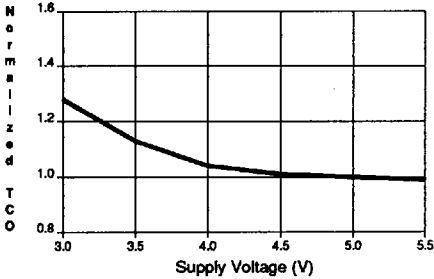

**NORMALIZED TCO  
vs. TEMPERATURE**

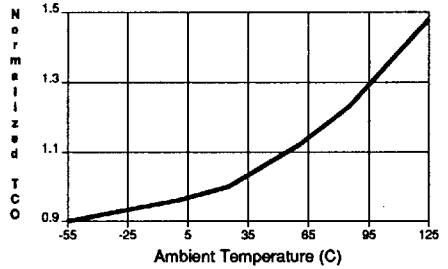

**NORMALIZED TS  
vs. SUPPLY VOLTAGE**

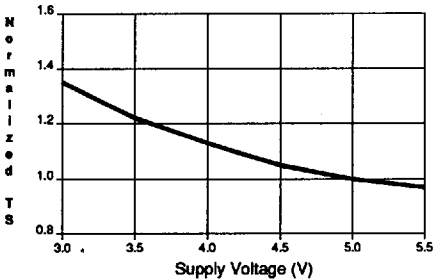

**NORMALIZED TS  
vs. TEMPERATURE**

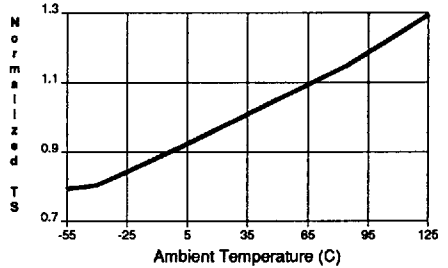

**DELTA TPD vs. OUTPUT LOADING**  
(VCC = 4.5V, OUTPUT LOAD = COMMERCIAL)

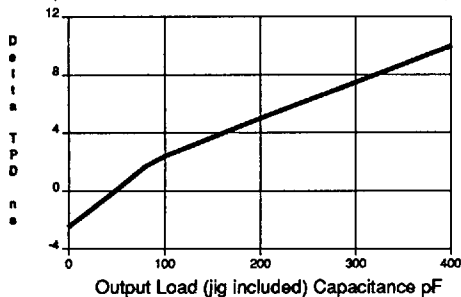

**DELTA TCO vs. OUTPUT LOADING**  
(VCC = 4.5V, OUTPUT LOAD = COMMERCIAL)

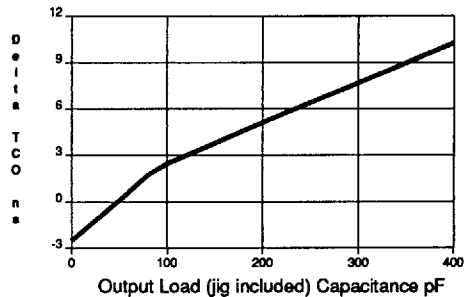



## Ordering Information

t <sub>PD</sub> (ns)	t <sub>s</sub> (ns)	t <sub>CO</sub> (ns)	Ordering Code	Package	Operation Range
20	10	14	AT22LV10-20DC AT22LV10-20GC AT22LV10-20JC AT22LV10-20KC AT22LV10-20LC AT22LV10-20NC AT22LV10-20PC AT22LV10-20SC	24DW3 24D3 28J 28KW 28LW 28L 24P3 24S	Commercial (0°C to 70°C)
			AT22LV10-20DI AT22LV10-20GI AT22LV10-20JI AT22LV10-20KI AT22LV10-20LI AT22LV10-20NI AT22LV10-20PI AT22LV10-20SI	24DW3 24D3 28J 28KW 28LW 28L 24P3 24S	Industrial (-40°C to 85°C)
25	12	17	AT22LV10-25DC AT22LV10-25GC AT22LV10-25JC AT22LV10-25KC AT22LV10-25LC AT22LV10-25NC AT22LV10-25PC AT22LV10-25SC	24DW3 24D3 28J 28KW 28LW 28L 24P3 24S	Commercial (0°C to 70°C)
			AT22LV10-25DI AT22LV10-25GI AT22LV10-25JI AT22LV10-25KI AT22LV10-25LI AT22LV10-25NI AT22LV10-25PI AT22LV10-25SI	24DW3 24D3 28J 28KW 28LW 28L 24P3 24S	Industrial (-40°C to 85°C)
			AT22LV10-25DM AT22LV10-25GM AT22LV10-25KM AT22LV10-25LM AT22LV10-25NM	24DW3 24D3 28KW 28LW 28L	Military (-55°C to 125°C)
			AT22LV10-25DM/883 AT22LV10-25GM/883 AT22LV10-25KM/883 AT22LV10-25LM/883 AT22LV10-25NM/883	24DW3 24D3 28KW 28LW 28L	Military/883D (-55°C to 125°C) Class B, Fully Compliant
30	15	20	AT22LV10-30DC AT22LV10-30GC AT22LV10-30JC AT22LV10-30KC AT22LV10-30LC AT22LV10-30NC AT22LV10-30PC AT22LV10-30SC	24DW3 24D3 28J 28KW 28LW 28L 24P3 24S	Commercial (0°C to 70°C)





## Ordering Information

tpd (ns)	ts (ns)	tco (ns)	Ordering Code	Package	Operation Range
30	15	20	AT22LV10-30DI	24DW3	Industrial (-40°C to 85°C)
			AT22LV10-30GI	24D3	
			AT22LV10-30JI	28J	
			AT22LV10-30KI	28KW	
			AT22LV10-30LI	28LW	
			AT22LV10-30NI	28L	
			AT22LV10-30PI	24P3	
			AT22LV10-30SI	24S	
			AT22LV10-30DM	24DW3	
AT22LV10-30GM	24D3				
AT22LV10-30KM	28KW				
AT22LV10-30LM	28LW				
AT22LV10-30NM	28L				
AT22LV10-30DM/883	24DW3	Military/883D (-55°C to 125°C) Class B, Fully Compliant			
AT22LV10-30GM/883	24D3				
AT22LV10-30KM/883	28KW				
AT22LV10-30LM/883	28LW				
AT22LV10-30NM/883	28L				

## Ordering Information

tpd (ns)	ts (ns)	tCO (ns)	Ordering Code	Package	Operation Range
25	17	14	AT22LV10L-25DC AT22LV10L-25GC AT22LV10L-25JC AT22LV10L-25KC AT22LV10L-25LC AT22LV10L-25NC AT22LV10L-25PC AT22LV10L-25SC	24DW3 24D3 28J 28KW 28LW 28L 24P3 24S	Commercial (0°C to 70°C)
			AT22LV10L-25DI AT22LV10L-25GI AT22LV10L-25JI AT22LV10L-25KI AT22LV10L-25LI AT22LV10L-25NI AT22LV10L-25PI AT22LV10L-25SI	24DW3 24D3 28J 28KW 28LW 28L 24P3 24S	Industrial (-40°C to 85°C)
30	20	17	AT22LV10L-30DC AT22LV10L-30GC AT22LV10L-30JC AT22LV10L-30KC AT22LV10L-30LC AT22LV10L-30NC AT22LV10L-30PC AT22LV10L-30SC	24DW3 24D3 28J 28KW 28LW 28L 24P3 24S	Commercial (0°C to 70°C)
			AT22LV10L-30DI AT22LV10L-30GI AT22LV10L-30JI AT22LV10L-30KI AT22LV10L-30LI AT22LV10L-30NI AT22LV10L-30PI AT22LV10L-30SI	24DW3 24D3 28J 28KW 28LW 28L 24P3 24S	Industrial (-40°C to 85°C)
			AT22LV10L-30DM AT22LV10L-30GM AT22LV10L-30KM AT22LV10L-30LM AT22LV10L-30NM	24DW3 24D3 28KW 28LW 28L	Military (-55°C to 125°C)
			AT22LV10L-30DM/883 AT22LV10L-30GM/883 AT22LV10L-30KM/883 AT22LV10L-30LM/883 AT22LV10L-30NM/883	24DW3 24D3 28KW 28LW 28L	Military/883D (-55°C to 125°C) Class B, Fully Compliant
35	22	20	AT22LV10L-35DC AT22LV10L-35GC AT22LV10L-35JC AT22LV10L-35KC AT22LV10L-35LC AT22LV10L-35NC AT22LV10L-35PC AT22LV10L-35SC	24DW3 24D3 28J 28KW 28LW 28L 24P3 24S	Commercial (0°C to 70°C)





## Ordering Information

tpd (ns)	ts (ns)	tco (ns)	Ordering Code	Package	Operation Range
35	22	20	AT22LV10L-35DI	24DW3	Industrial (-40°C to 85°C)
			AT22LV10L-35GI	24D3	
			AT22LV10L-35JI	28J	
			AT22LV10L-35KI	28KW	
			AT22LV10L-35LI	28LW	
			AT22LV10L-35NI	28L	
			AT22LV10L-35PI	24P3	
			AT22LV10L-35SI	24S	
			AT22LV10L-35DM	24DW3	
AT22LV10L-35GM	24D3				
AT22LV10L-35KM	28KW				
AT22LV10L-35LM	28LW				
AT22LV10L-35NM	28L	Military/883D (-55°C to 125°C) Class B, Fully Compliant			
AT22LV10L-35DM/883	24DW3				
AT22LV10L-35GM/883	24D3				
AT22LV10L-35KM/883	28KW				
AT22LV10L-35LM/883	28LW				
AT22LV10L-35NM/883	28L				

Package Type	
<b>24DW3</b>	24 Lead, 0.300" Wide, Windowed, Ceramic Dual Inline Package (Cerdip)
<b>24D3</b>	24 Lead, 0.300" Wide, Non-Windowed (OTP), Ceramic Dual Inline Package (Cerdip)
<b>28J</b>	28 Lead, Plastic J-Leaded Chip Carrier OTP (PLCC)
<b>28KW</b>	28 Lead, Windowed, Ceramic J-Leaded Chip Carrier (JLCC)
<b>28LW</b>	28 Pad, Windowed, Ceramic Leadless Chip Carrier (LCC)
<b>28L</b>	28 Pad, Non-Windowed, Ceramic Leadless Chip Carrier OTP (LCC)
<b>24P3</b>	24 Lead, 0.300" Wide, Plastic Dual Inline Package OTP (PDIP)
<b>24S</b>	24 Lead, 0.300" Wide, Plastic Gull Wing Small Outline OTP (SOIC)