

FEATURES

Wide Operating Range: 50 μ A–10 mA
Initial Accuracy: $\pm 0.1\%$ Max
Temperature Drift: ± 50 ppm/ $^{\circ}$ C Max
Output Impedance: 0.5 Ω Max
Wideband Noise (10 Hz–10 kHz): 20 μ V rms
Operating Temperature Range: -40° C to $+85^{\circ}$ C
High ESD Rating
 4 kV Human Body Model
 400 V Machine Model
Compact, Surface-Mount, SOT-23 and SC70 Packages

PIN CONFIGURATIONS

SOT-23 Package

SC70 Package

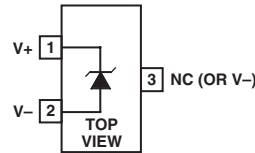

NC = NO CONNECT

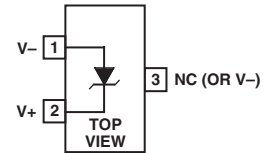

NC = NO CONNECT

GENERAL DESCRIPTION

The AD1580 is a low cost, 2-terminal (shunt), precision bandgap reference. It provides an accurate 1.225 V output for input currents between 50 μ A and 10 mA.

The AD1580's superior accuracy and stability is made possible by the precise matching and thermal tracking of on-chip components. Proprietary curvature correction design techniques have been used to minimize the nonlinearities in the voltage output temperature characteristics. The AD1580 is stable with any value of capacitive load.

The low minimum operating current makes the AD1580 ideal for use in battery powered 3 V or 5 V systems. However, the wide operating current range means that the AD1580 is extremely versatile and suitable for use in a wide variety of high current applications.

The AD1580 is available in two grades, A and B, both of which are provided in the SOT-23 and SC70 packages, the smallest surface-mount package available. Both grades are specified over the industrial temperature range of -40° C to $+85^{\circ}$ C.

TARGET APPLICATIONS

1. Portable, Battery-Powered Equipment:
Cellular Phones, Notebook Computers, PDAs, GPSes, and DMMs
2. Computer Workstations Suitable for use with a wide range of video RAMDACs
3. Smart Industrial Transmitters
4. PCMCIA Cards
5. Automotive
6. 3 V/5 V 8-Bit to 12-Bit Data Converters

*Protected by U.S. Patent No. 5,969,657; other patents pending.

REV. A

Information furnished by Analog Devices is believed to be accurate and reliable. However, no responsibility is assumed by Analog Devices for its use, nor for any infringements of patents or other rights of third parties that may result from its use. No license is granted by implication or otherwise under any patent or patent rights of Analog Devices. Trademarks and registered trademarks are the property of their respective owners.

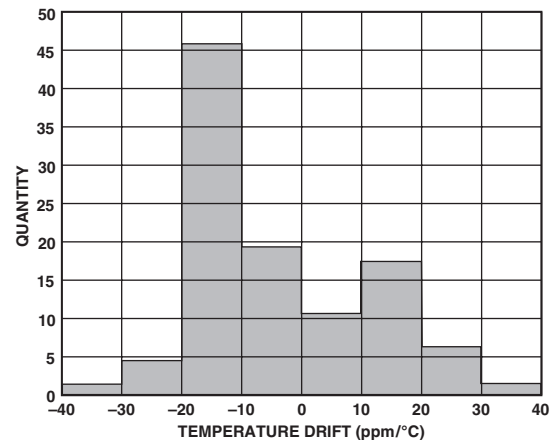

Figure 1. Reverse Voltage Temperature Drift Distribution

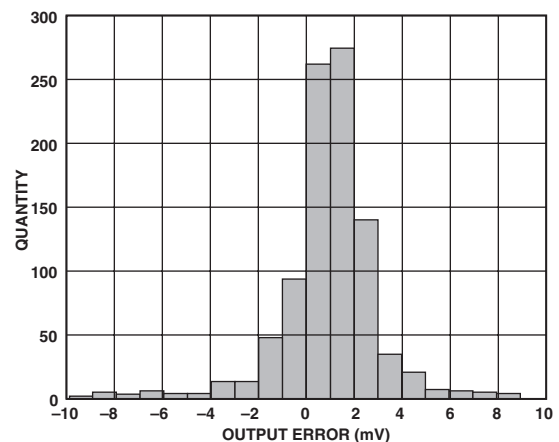

Figure 2. Reverse Voltage Error Distribution

AD1580—SPECIFICATIONS (@ T_A = 25°C, I_{IN} = 100 μA, unless otherwise noted.)

Model	AD1580A			AD1580B			Unit
	Min	Typ	Max	Min	Typ	Max	
REVERSE VOLTAGE OUTPUT (SOT-23)	1.215	1.225	1.235	1.224	1.225	1.226	V
REVERSE VOLTAGE OUTPUT (SC70)				1.2225	1.225	1.2275	V
REVERSE VOLTAGE TEMPERATURE DRIFT -40°C to +85°C			100			50	ppm/°C
MINIMUM OPERATING CURRENT, T _{MIN} to T _{MAX}			50			50	μA
REVERSE VOLTAGE CHANGE WITH REVERSE CURRENT							
50 μA < I _{IN} < 10 mA, T _{MIN} to T _{MAX}		2.5	6		2.5	6	mV
50 μA < I _{IN} < 1 mA, T _{MIN} to T _{MAX}		0.5			0.5		mV
DYNAMIC OUTPUT IMPEDANCE (ΔV _R /ΔI _R) I _{IN} = 1 mA ± 100 μA (f = 120 Hz)		0.4	1		0.4	0.5	Ω
OUTPUT NOISE							
RMS Noise Voltage: 10 Hz to 10 kHz		20			20		μV rms
Low Frequency Noise Voltage: 0.1 Hz to 10 Hz		5			5		μV p-p
TURN-ON SETTLING TIME TO 0.1% ¹		5			5		μs
OUTPUT VOLTAGE HYSTERESIS ²		80			80		μV
TEMPERATURE RANGE							
Specified Performance, T _{MIN} to T _{MAX}	-40		+85	-40		+85	°C
Operating Range ³	-55		+125	-55		+125	°C

NOTES

¹Measured with no load capacitor.

²Output hysteresis is defined as the change in the +25°C output voltage after a temperature excursion to +85°C and then to -40°C.

³The operating temperature range is defined as the temperature extremes at which the device will continue to function. Parts may deviate from their specified performance.

Specifications subject to change without notice.

ABSOLUTE MAXIMUM RATINGS¹

Reverse Current	25 mA
Forward Current	20 mA
Internal Power Dissipation ²	
SOT-23 (RT)	0.3 W
Storage Temperature Range	-65°C to +150°C
Operating Temperature Range	
AD1580/RT	-55°C to +125°C
Lead Temperature, Soldering	
Vapor Phase (60 sec)	+215°C
Infrared (15 sec)	+220°C
ESD Susceptibility ³	
Human Body Model	4 kV
Machine Model	400 V

NOTES

¹Stresses above those listed under “Absolute Maximum Ratings” may cause permanent damage to the device. This is a stress rating only and functional operation of the device at these or any other conditions above those indicated in the operational section of this specification is not implied. Exposure to absolute maximum rating conditions for extended periods may affect device reliability.

²Specification is for device in free air at 25°C: SOT-23 package: θ_{JA} = 300°C/W.

³The human body model is a 100 pF capacitor discharged through 1.5 kΩ. For the machine model, a 200 pF capacitor is discharged directly into the device.

CAUTION

ESD (electrostatic discharge) sensitive device. Electrostatic charges as high as 4000 V readily accumulate on the human body and test equipment and can discharge without detection. Although the AD1580 features proprietary ESD protection circuitry, permanent damage may occur on devices subjected to high energy electrostatic discharges. Therefore, proper ESD precautions are recommended to avoid performance degradation or loss of functionality.

ORDERING GUIDE

Model	Initial Output Error	Temperature Coefficient	Package Option	Branding
AD1580ART-R2 ¹	10 mV	100 ppm/°C	RT-3	0Axx
AD1580ART-REEL ²	10 mV	100 ppm/°C	RT-3	0Axx
AD1580ART-REEL7 ³	10 mV	100 ppm/°C	RT-3	0Axx
AD1580BRT-R2 ¹	1 mV	50 ppm/°C	RT-3	0Bxx
AD1580BRT-REEL7 ³	1 mV	50 ppm/°C	RT-3	0Bxx
AD1580BKSZ-REEL ⁴	2.5 mV	50 ppm/°C	KS-3	K0B

NOTES

¹R2 is 250 piece reel.

²Provided on a 13-inch reel containing 10,000 pieces.

³Provided on a 7-inch reel containing 3,000 pieces.

⁴Pb-free.

PACKAGE BRANDING INFORMATION

In the SOT-23 package (RT), four marking fields identify the device generic, grade, and date of processing. The first field is the product identifier. A 0 identifies the generic as the AD1580. The second field indicates the device grade; A or B. In the third field a numeral or letter indicates a calendar year; 5 for 1995, A for 2001. In the fourth field, letters A through Z represent a two week window within the calendar year; starting with A for the first two weeks of January.



Typical Performance Characteristics—AD1580

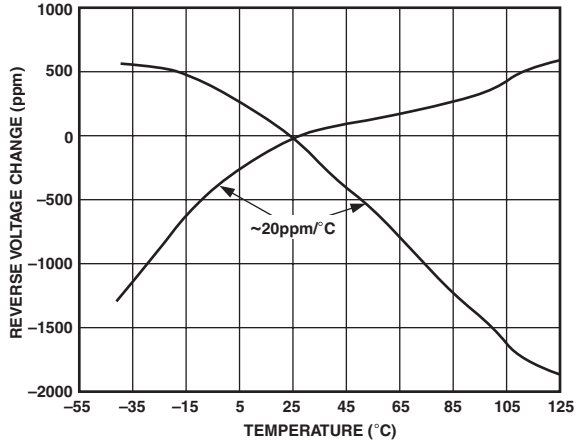

TPC 1. Output Drift for Different Temperature Characteristics

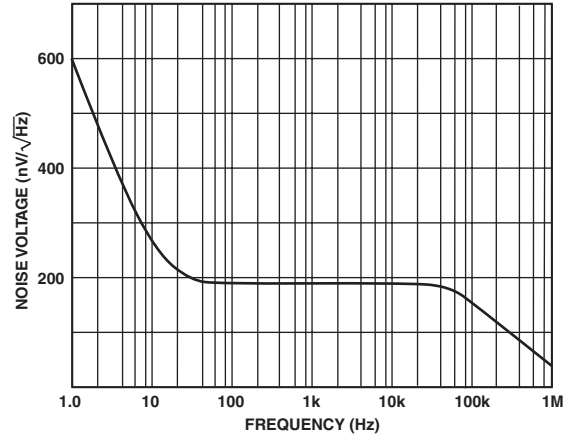

TPC 3. Noise Spectral Density

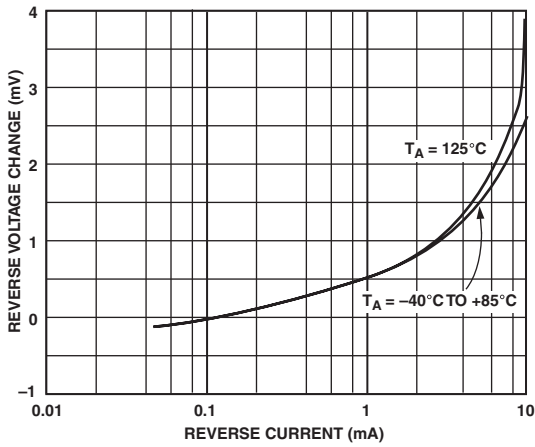

TPC 2. Output Voltage Error vs. Reverse Current

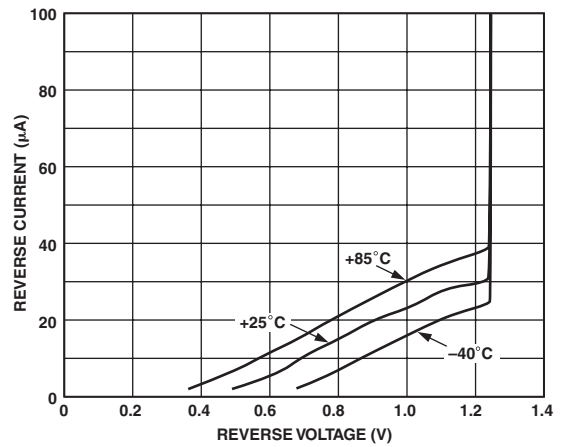

TPC 4. Reverse Current vs. Reverse Voltage

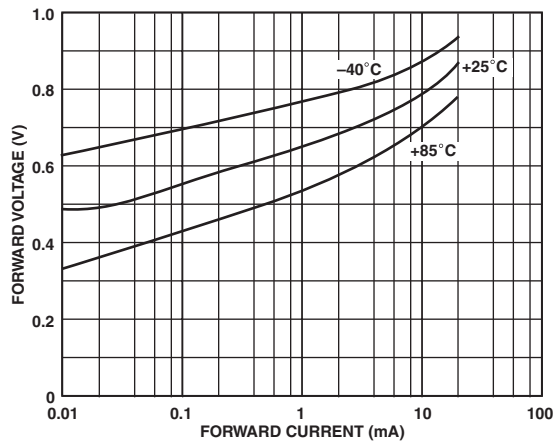

TPC 5. Forward Voltage vs. Forward Current

AD1580

THEORY OF OPERATION

The AD1580 uses the bandgap concept to produce a stable, low temperature coefficient voltage reference suitable for high accuracy data acquisition components and systems. The device makes use of the underlying physical nature of a silicon transistor base emitter voltage in the forward biased operating region. All such transistors have an approximately $-2 \text{ mV}/^\circ\text{C}$ temperature coefficient, which is unsuitable for use directly as a low TC reference; however, extrapolation of the temperature characteristic of any one of these devices to absolute zero (with collector current proportional to absolute temperature) reveals that its V_{BE} will go to approximately the silicon bandgap voltage. Thus, if a voltage could be developed with an opposing temperature coefficient to sum with V_{BE} , a zero TC reference would result. The AD1580 circuit in Figure 3 provides such a compensating voltage, V_1 , by driving two transistors at different current densities and amplifying the resultant V_{BE} difference (ΔV_{BE} , which has a positive TC). The sum of V_{BE} and V_1 provides a stable voltage reference.

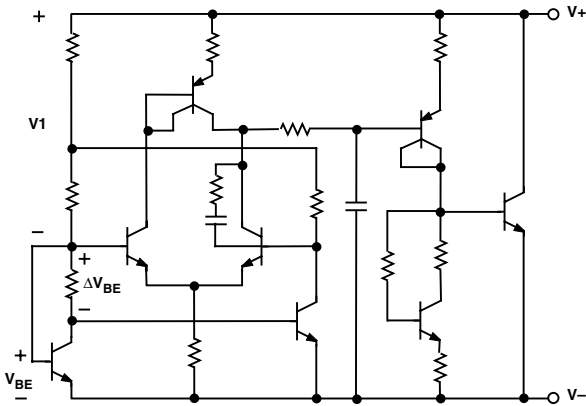

Figure 3. Schematic Diagram

APPLYING THE AD1580

The AD1580 is simple to use in virtually all applications. To operate the AD1580 as a conventional shunt regulator (Figure 4a), an external series resistor is connected between the supply voltage and the AD1580. For a given supply voltage, the series resistor, R_S , determines the reverse current flowing through the AD1580. The value of R_S must be chosen to accommodate the expected variations of the supply voltage, V_S , load current, I_L , and the AD1580 reverse voltage, V_R , while maintaining an acceptable reverse current, I_R , through the AD1580.

The minimum value for R_S should be chosen when V_S is at its minimum and I_L and V_R are at their maximum—while maintaining the minimum acceptable reverse current.

The value of R_S should be large enough to limit I_R to 10 mA when V_S is at its maximum and I_L and V_R are at their minimum.

The equation for selecting R_S is as follows:

$$R_S = (V_S - V_R) / (I_R + I_L)$$

Figure 4b shows a typical connection of the AD1580BRT operating at a minimum of 100 μA . This connection can provide $\pm 1 \text{ mA}$ to the load, while accommodating $\pm 10\%$ power supply variations.

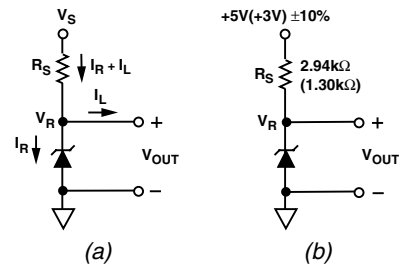

Figure 4. Typical Connection Diagram

TEMPERATURE PERFORMANCE

The AD1580 is designed for reference applications where stable temperature performance is important. Extensive temperature testing and characterization ensure that the device's performance is maintained over the specified temperature range.

Some confusion exists in the area of defining and specifying reference voltage error over temperature. Historically, references have been characterized using a maximum deviation per degree centigrade, e.g., 50 ppm/ $^\circ\text{C}$. However, because of nonlinearities in temperature characteristics that originated in standard Zener references (such as S type characteristics), most manufacturers now use a maximum limit error band approach to specify devices. This technique involves the measurement of the output at three or more different temperatures to guarantee that the voltage will fall within the given error band. The proprietary curvature correction design techniques used to minimize the AD1580 nonlinearities allow the temperature performance to be guaranteed using the maximum deviation method. This method is of more use to a designer than the one that simply guarantees the maximum error band over the entire temperature change.

Figure 5 shows a typical output voltage drift for the AD1580 and illustrates the methodology. The maximum slope of the two diagonals drawn from the initial output value at $+25^\circ\text{C}$ to the output values at $+85^\circ\text{C}$ and -40°C determines the performance grade of the device. For a given grade of the AD1580, the designer can easily determine the maximum total error from the initial tolerance plus temperature variation.

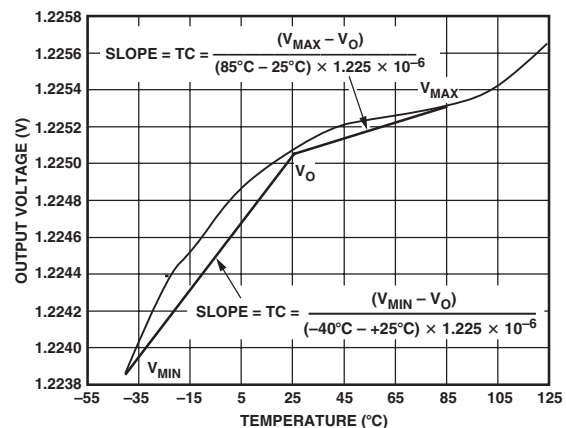

Figure 5. Output Voltage vs. Temperature

For example, the AD1580BRT initial tolerance is $\pm 1 \text{ mV}$; a $\pm 50 \text{ ppm}/^\circ\text{C}$ temperature coefficient corresponds to an error band of $\pm 4 \text{ mV}$ ($50 \times 10^{-6} \times 1.225 \text{ V} \times 65^\circ\text{C}$) thus, the unit is guaranteed to be $1.225 \text{ V} \pm 5 \text{ mV}$ over the operating temperature range.

Duplication of these results requires a combination of high accuracy and stable temperature control in a test system. Evaluation of the AD1580 will produce a curve similar to that in TPC 1 and Figure 5.

VOLTAGE OUTPUT NONLINEARITY VERSUS TEMPERATURE

When a reference is used with data converters, it is important to understand how temperature drift affects the overall converter performance. The nonlinearity of the reference output drift represents additional error that is not easily calibrated out of the system. This characteristic (Figure 6) is generated by normalizing the measured drift characteristic to the end point average drift. The residual drift error of approximately 500 ppm shows that the AD1580 is compatible with systems that require 10-bit accurate temperature performance.

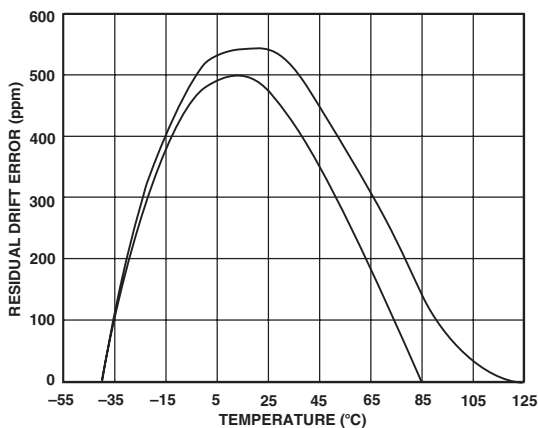

Figure 6. Residual Drift Error

REVERSE VOLTAGE HYSTERESIS

A major requirement for high performance industrial equipment manufacturers is a consistent output voltage at nominal temperature following operation over the operating temperature range. This characteristic is generated by measuring the difference between the output voltage at +25°C after operation at +85°C and the output, at +25°C after operation at -40°C. Figure 7 displays the hysteresis associated with the AD1580. This characteristic exists in all references and has been minimized in the AD1580.

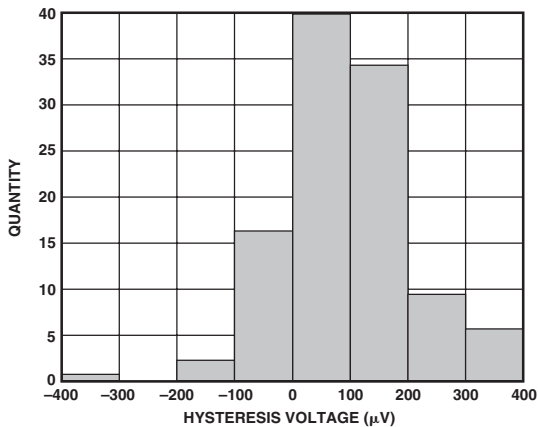

Figure 7. Reverse Voltage Hysteresis Distribution

OUTPUT IMPEDANCE VERSUS FREQUENCY

Understanding the effect of the reverse dynamic output impedance in a practical application may be important to successfully apply the AD1580. A voltage divider is formed by the AD1580's output impedance and the external source impedance. When an external source resistor of about 30 kΩ ($I_R = 100 \mu A$) is used, 1% of the noise from a 100 kHz switching power supply is developed at the output of the AD1580. Figure 8 shows how a 1 µF load capacitor connected directly across the AD1580 reduces the effect of power supply noise to less than 0.01%.

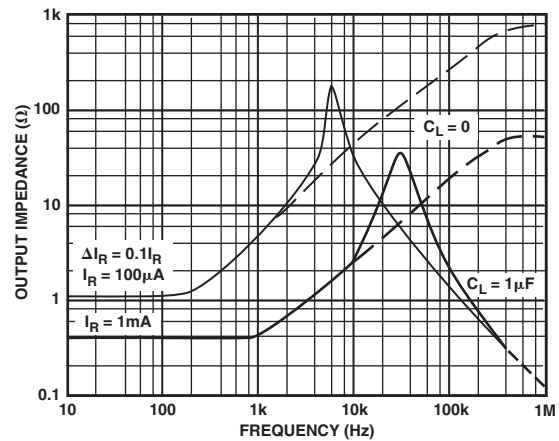

Figure 8. Output Impedance vs. Frequency

NOISE PERFORMANCE AND REDUCTION

The noise generated by the AD1580 is typically less than 5 µV p-p over the 0.1 Hz to 10 Hz band. Figure 9 shows the 0.1 Hz to 10 Hz noise of a typical AD1580. Noise in a 10 Hz to 10 kHz bandwidth is approximately 20 µV rms (Figure 10a). If further noise reduction is desired, a 1-pole low-pass filter may be added between the output pin and ground. A time constant of 0.2 ms will have a -3 dB point at about 800 Hz, and will reduce the high frequency noise to about 6.5 µV rms, (Figure 10b). A time constant of 960 ms will have a -3 dB point at 165 Hz, and will reduce the high frequency noise to about 2.9 µV rms (Figure 10c).

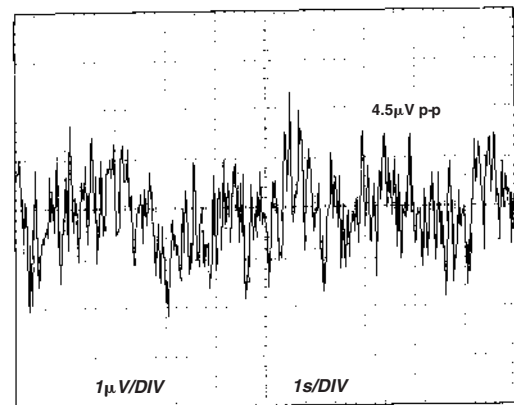

Figure 9. 0.1 Hz-10 Hz Voltage Noise

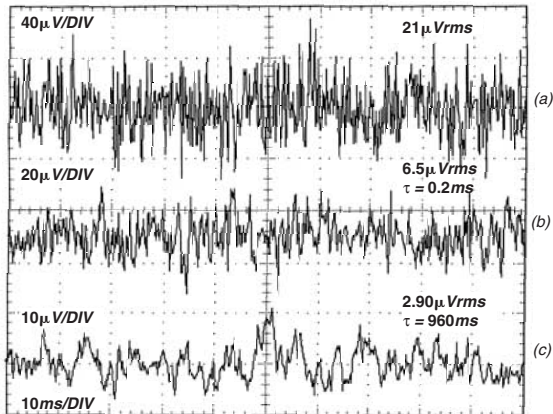

Figure 10. Total RMS Noise

TURN-ON TIME

Many low power instrument manufacturers are becoming increasingly concerned with the turn-on characteristics of components being used in their systems. Fast turn-on components often enable the end user to keep power off it is when not needed and yet those components respond quickly when the power is turned on for operation. Figure 11a displays the turn-on characteristic of the AD1580. Upon application of power (cold start), the time required for the output voltage to reach its final value within a specified error is the turn-on settling time. Two components normally associated with this are time for active circuits to settle and time for thermal gradients on the chip to stabilize. This characteristic is generated from cold start operation and represents the true turn-on waveform after power up. Figure 12 shows both the coarse and fine turn-on settling characteristics of the device; the total settling time to within 1.0 mV is about 6 μs, and there is no long thermal tail when the horizontal scale is expanded to 2 ms/div.

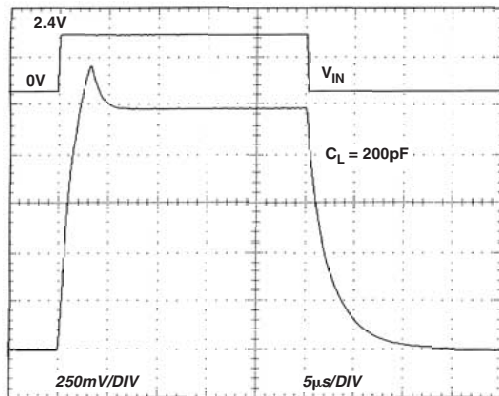

Figure 11a. Response Time

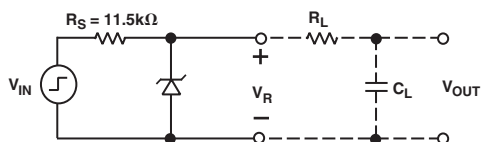

Figure 11b. Turn-On, Settling, and Transient Test Circuit

Output turn-on time is modified when an external noise reduction filter is used. When present, the time constant of the filter will dominate overall settling.

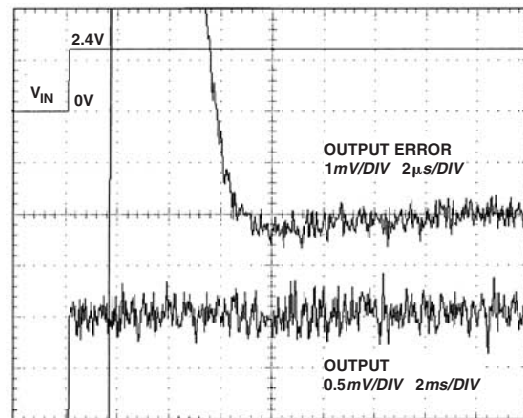

Figure 12. Turn-On Settling

TRANSIENT RESPONSE

Many A/D and D/A converters present transient current loads to the reference. Poor reference response can degrade the converter's performance.

Figure 13 displays both the coarse and fine settling characteristics of the device to load transients of $\pm 50 \mu\text{A}$.

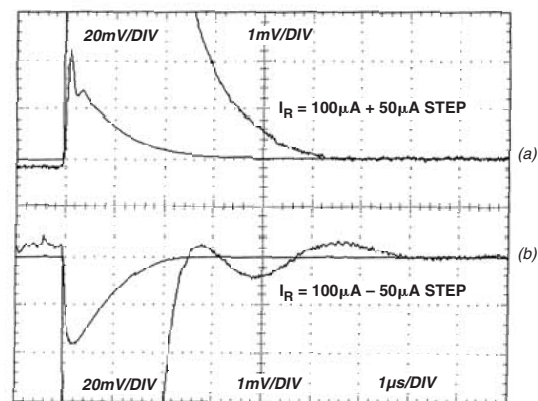

Figure 13. Transient Settling

Figure 13a shows the settling characteristics of the device for an increased reverse current of 50 μA. Figure 13b shows the response when the reverse current is decreased by 50 μA. The transients settle to 1 mV in about 3 μs.

Attempts to drive a large capacitive load (in excess of 1,000 pF) may result in ringing, as shown in the step response photo (Figure 14). This is due to the additional poles formed by the load capacitance and the output impedance of the reference. A recommended method of driving capacitive loads of this magnitude is shown in Figure 11b. A resistor isolates the capacitive load from the output stage, while the capacitor provides a single-pole low-pass filter and lowers the output noise.

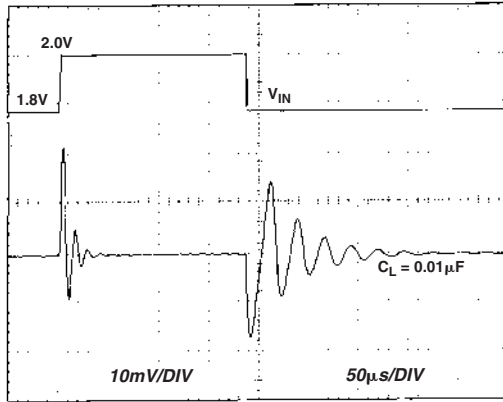

Figure 14. Transient Response with Capacitive Load

PRECISION MICROPOWER LOW DROPOUT REFERENCE

The circuit in Figure 15 provides an ideal solution for making a stable voltage reference with low standby power consumption, low input/output dropout capability, and minimum noise output. The amplifier both buffers and optionally scales up the AD1580 output voltage, V_R . Output voltages as high as 2.1 V can supply 1 mA of load current. A one-pole filter connected between the AD1580 and the OP193 input may be used to achieve low output noise. The nominal quiescent power consumption is a mere 200 μ W.

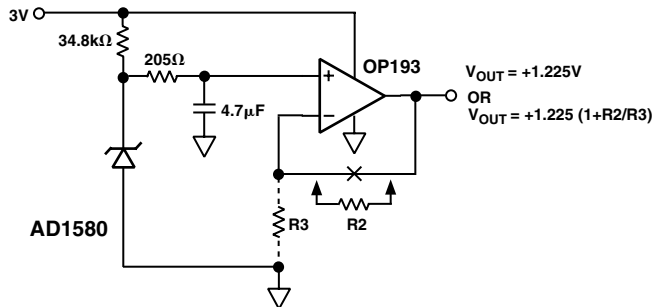

Figure 15. Micropower Buffered Reference

USING THE AD1580 WITH 3 V DATA CONVERTERS

The AD1580's low output drift (50 ppm/°C) and compact subminiature SOT-23 package makes it ideally suited for today's high performance converters in space critical applications.

One family of ADCs that the AD1580 is well suited for is the AD7714-3 and AD7715-3. The AD7714/AD7715 are charge-balancing (Σ - Δ) A/D converters with on-chip digital filtering intended for the measurement of wide dynamic range, low frequency signals such as those representing chemical, physical, or biological processes. Figure 16 shows the AD1580 connected to the AD7714/AD7715 for 3 V operation.

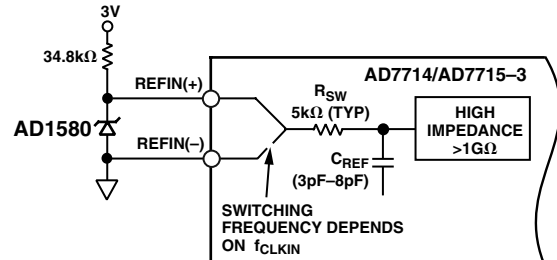

Figure 16. Reference Circuit for the AD7714/AD7715-3

The AD1580 is ideal for creating the reference level to use with 12-bit multiplying DACs such as the AD7943, AD7945, and AD7948. In the single-supply bias mode (Figure 17), the impedance seen looking into the I_{OUT2} terminal changes with DAC code. If the AD1580 drives I_{OUT2} and AGND directly, less than 0.2 LSBs of additional linearity error will result. The buffer amp eliminates any linearity degradation that could result from variations in the reference level.

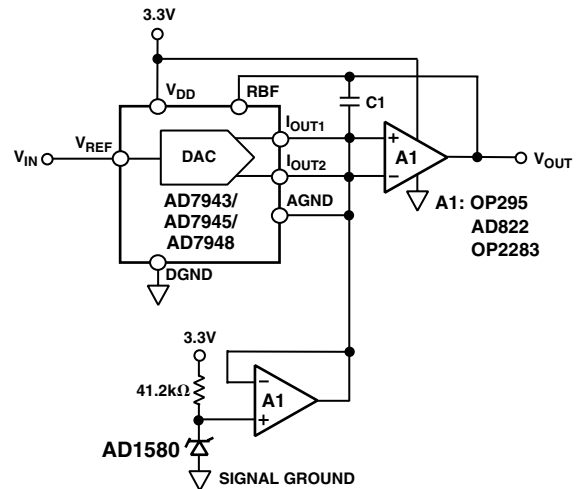

Figure 17. Single-Supply System

