

MODEL 82 SW

1/4" Diameter Sealed Switch

NEW PRODUCT



ELECTRICAL

Input Voltage, Maximum	16 Vdc
Slider Current, Maximum	100mA or within rated power, whichever is less
Insulation Resistance, Minimum	10 Megohms
Contact Resistance, Maximum	2 Ohms
Contact Timing	Non-shorting
Switch Type	Single Pole / Double Throw (SPDT)

ENVIRONMENTAL

Seal	85°C Fluorinert® (No Leaks)
Operating Temperature Range	-55°C to +125°C
Thermal Shock	5 cycles, -55°C to +125°C
Moisture Resistance	Ten 24 hour cycles
Shock, 6ms Sawtooth	100G's
Vibration	20G's, 10 to 2,000 Hz
Rotational Life	200 cycles
Resistance to Solder Heat	260°C for 10 sec.

MECHANICAL

Stop Strength	5 oz.-in.
Torque, Starting Maximum	3 oz.-in. (0.021 N-m)
Weight, Nominal	.02 oz. (0.60 grams)

Fluorinert® is a registered trademark of 3M Company.
Specifications subject to change without notice.
Last Update: 06/24/02.

TOP ADJUSTMENT (Inch/mm)

Model 82PSW, 82PFSW

Model	Dim. A
82PSW	$\frac{.25}{6.35}$ Min.
82PFSW	$\frac{.625}{15.875}$ Min.

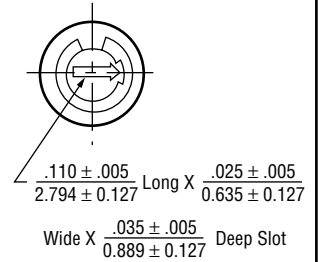
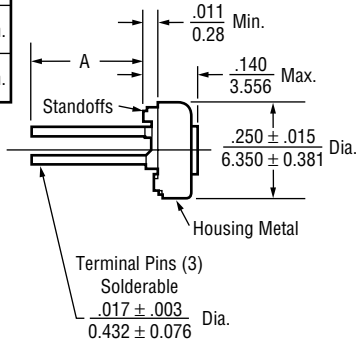
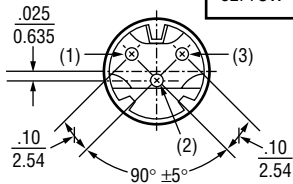

Note: Model 82PSW dimensions applicable to all models except as noted.

Model 82MSW

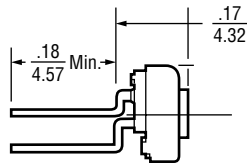
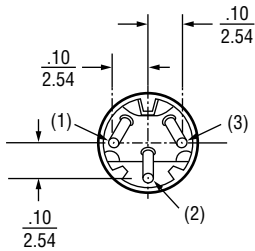

Model 82WSW

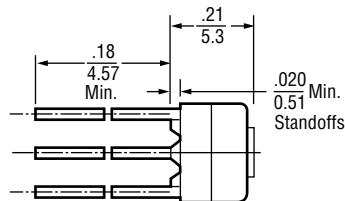
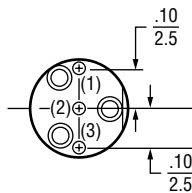

SIDE ADJUSTMENT (Inch/mm)

Model 82PASW

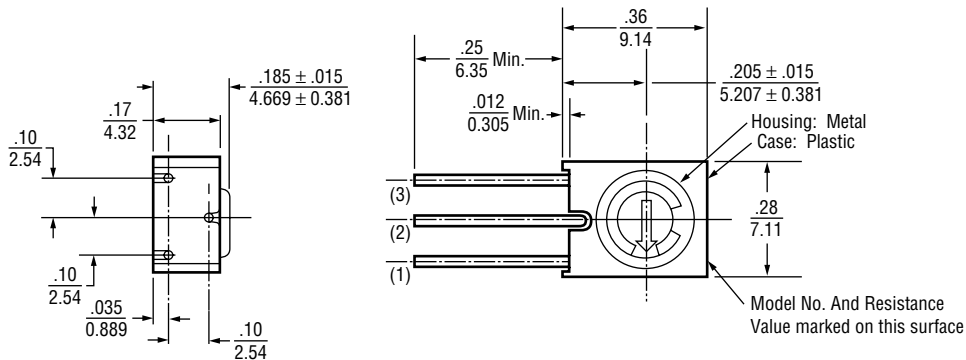

PACKAGING

Standard: Boxes

Capacity	=	50 Units (82PASW, 82PFSW)
	=	100 Units (All other styles)

Option: Tubes

All units oriented with #1 pin to same side.

	Pin Style	PASW	PSW,MSW,WSW
Magazine	Width	= 0.28"	0.34"
	Height	= 0.94"	0.65"
	Length	= 15.6"	27.5"
	Capacity	= 50 Units	100 Units

Option: Tape & Reel, Ammo Pack (Available for 82WSW Only)

All units oriented with #1 pin to the right of the direction of feed.

	Seat Plane to Centerline of Sprocket Hole	=	.71" (18.03 mm)
Tape	Width	=	18 mm
	Sprocket	=	Single Hole .50" spacing
	Capacity	=	1,000 Units
Reel	Diameter	=	14" (356 mm)
Ammo	Tape Fold	=	12" (305 mm)
	Box	=	1.5" x 13" x 10"

ORDERING INFORMATION

Standard:

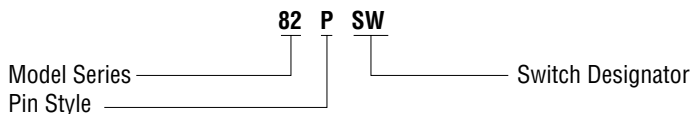

Option:

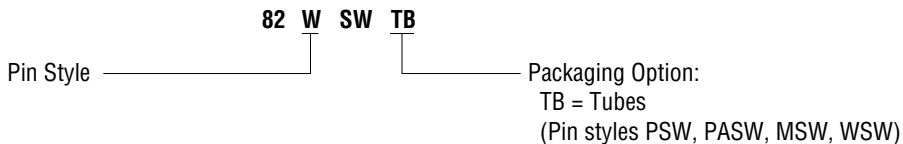

Option:

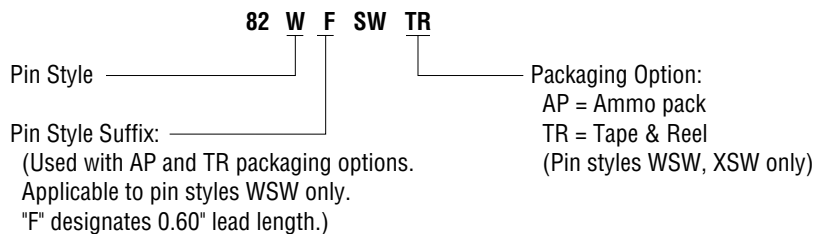

CIRCUIT DIAGRAM

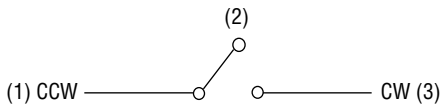

NOTES

Metric equivalents, based on 1 inch = 25.4mm are rounded to the same number of significant figures as in the original English units and are provided for general information only.

Tolerances unless otherwise specified:
Linear = ± .01 inches (.25mm)
Angular = ± 2 degrees

