

8880 N

AC axial compact fan



ebm-papst St. Georgen GmbH & Co. KG

Hermann-Papst-Straße 1

78112 St. Georgen

Phone: +49 7724 81-0

Fax: +49 7724 81-1309

www.ebmpapst.com

info2@de.ebmpapst.com

Nominal data

Type	8880 N	
Nominal voltage	[VAC]	230
Frequency	[Hz]	50
Speed	[min ⁻¹]	1750
Power input	[W]	9.0
Min. ambient temperature	[°C]	-10
Max. ambient temperature	[°C]	80
Air flow	[m ³ /h]	30
Sound power level	[B]	3.3
Sound pressure level	[dB(A)]	18

ml = max. load · me = max. efficiency · rfa = running at free air · cs = customer specs · cu = customer unit
Subject to alterations

Technical features

Dimensions	80 x 80 x 38 mm
General description	AC fan with external rotor shaded-pole motor.
Connection line	2 single strands AWG 28, TR 64
Direction of protection	Right, looking at rotor
Direction of air flow	Air exhaust over bars
Bearing	Sintec sleeve bearing system
Lifetime L10 at 40 °C	60000 h
Lifetime L10 at maximum temperature	25000 h
Mass	0.490 kg
Housing material	Metal
Material of impeller	Metal
Motor protection	Protected from overload using impedance protection
Approval	VDE, CSA, UL, CE

Product drawing

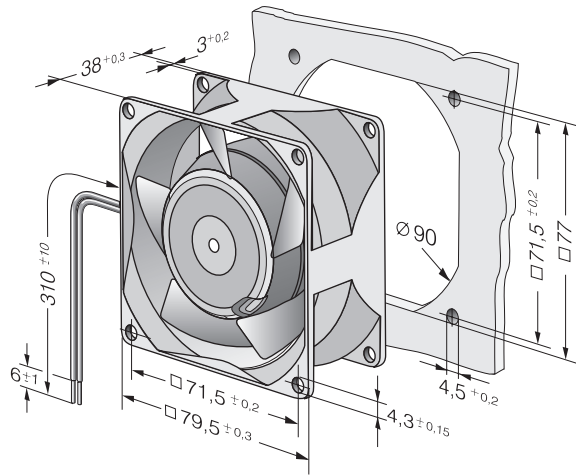

Charts: Air flow

