

△1
ターミナル装着図
TERMINAL ASSEMBLY DRAWING

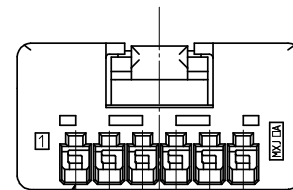
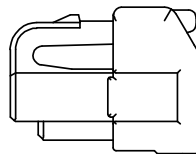
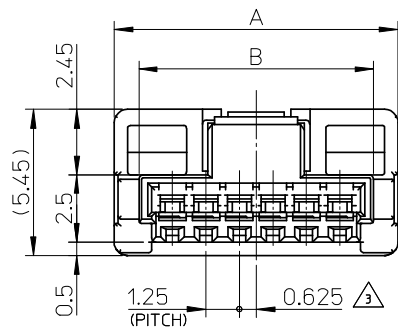

回路番号 1
CKT NO. 1

NOTES

- △1 適合ターミナル: 502381-00**
APPLICABLE TERMINAL: 502381-00**
- 2. 嵌合相手: 502382-**09 / 502386-**09
MATE WITH: 502382-**09 / 502386-**09
- △3 極数/2=偶数に適用。
APPLY FOR CKT. SIZE / 2 = EVEN.
- 4. 本製品のプラスチック部に黒点等が確認される場合や色合いが異なる場合がありますが、製品性能に影響はありません。
THERE IS NO INFLUENCE IN THE PRODUCT PERFORMANCE THOUGH THE BLACK SPOT ETC. MIGHT BE CONFIRMED TO THE PLASTIC PART OF THIS PRODUCT AND THE SHADE MIGHT BE DIFFERENT.
- 5. アプリケーション仕様書(コネクタ取扱説明書): AS-502380-001
APPLICATION SPECIFICATIONS (CONNECTOR MANUAL): AS-502380-001
- 6. 製品仕様書: PS-502382-001
Product specification: PS-502382-001



2 CKT.

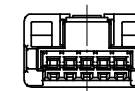

5 CKT.



3 CKT.

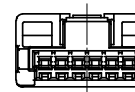

6 CKT.



4 CKT.

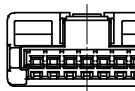

7 CKT.

極数の種類 (正面図)
KIND OF CKT. NO. (FRONT VIEW)

10	11.85	502380-0700	7
8.75	10.6	502380-0600	6
7.5	9.35	502380-0500	5
6.25	8.1	502380-0400	4
5	6.85	502380-0300	3
3.75	5.6	502380-0200	2
B	A	製品番号 MATERIAL NO.	極数 CKT. NO.

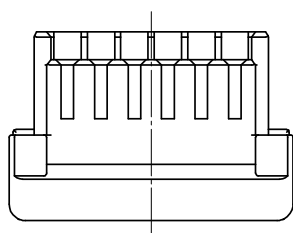

REVISED EC NO: J2008-1880 DRW: NISHI 2007/12/18 CH: KDK ASAKAWA 2007/12/19 APPR: YO ITO 2007/12/19	GENERAL TOLERANCES (UNLESS SPECIFIED)		DIMENSION STYLE MM ONLY	SCALE 5:1	DESIGN UNITS METRIC	THIRD ANGLE PROJECTION	
	10 UNDER	±0.2	DRAWN BY DATE T. MIYAZAKI 2006/08/28	TITLE 1.25 W/B CONN. SINGLE PLUG HOUSING 2-7CKT.			
	10 OVER 30 UNDER	±0.25	CHECKED BY DATE K. ASAKAWA 2006/08/28				
	30 OVER	±0.3	APPROVED BY DATE YO. ITO 2006/08/28	MOLEX INCORPORATED			
	ANGULAR	±3 °	MATERIAL NO.				
DRAFT WHERE APPLICABLE MUST REMAIN WITHIN DIMENSIONS			SEE TABLE	SD-502380-001		1 OF 1	
THIS DRAWING CONTAINS INFORMATION THAT IS PROPRIETARY TO MOLEX INCORPORATED AND SHOULD NOT BE USED WITHOUT WRITTEN PERMISSION							

部品 PART	材質 MATERIAL
ハウジング HOUSING	ポリブチレンテレフタレート UL94V-0 色:白 POLYBUTYLENE TEREPHTHALATE UL94V-0 COLOR:WHITE

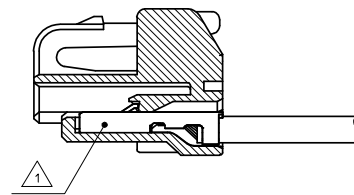
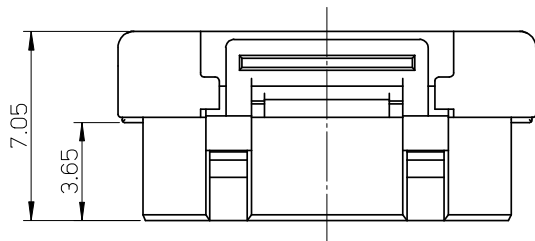

ターミナル装着図
TERMINAL ASSEMBLY DRAWING

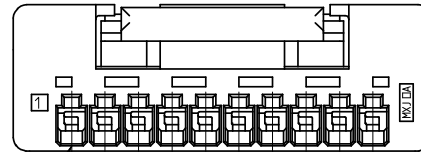
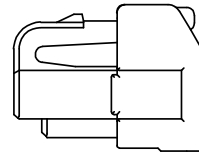
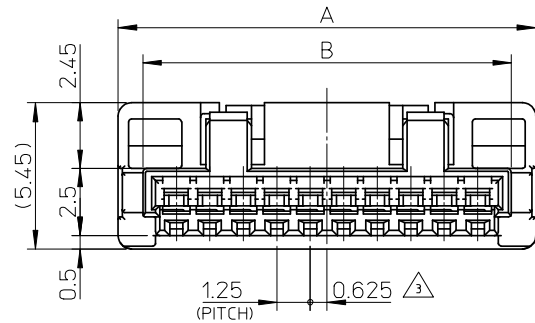

回路番号 1
CKT. NO. 1

NOTES

- △ 適合ターミナル: 502381-00**
APPLICABLE TARMINAL: 502381-00**
- 嵌合相手: 502382-**09 / 502386-**09
MATE WITH: 502382-**09 / 502386-**09
- △ 極数/2=偶数に適用。
APPLY FOR CKT. SIZE / 2 = EVEN.
- 本製品のプラスチック部に黒点等が確認される場合や色合いが異なる場合がありますが、製品性能に影響はありません。
THERE IS NO INFLUENCE IN THE PRODUCT PERFORMANCE THOUGH THE BLACK SPOT ETC. MIGHT BE CONFIRMED TO THE PLASTIC PART OF THIS PRODUCT AND THE SHADE MIGHT BE DIFFERENT.
- アプリケーション仕様書(コネクタ取扱説明書): AS-502380-001
APPLICATION SPECIFICATIONS (CONNECTOR MANUAL): AS-502380-001.
- 製品仕様書: PS-502382-001
Product specification: PS-502382-001
- ELV AND RoHS COMPLIANT.

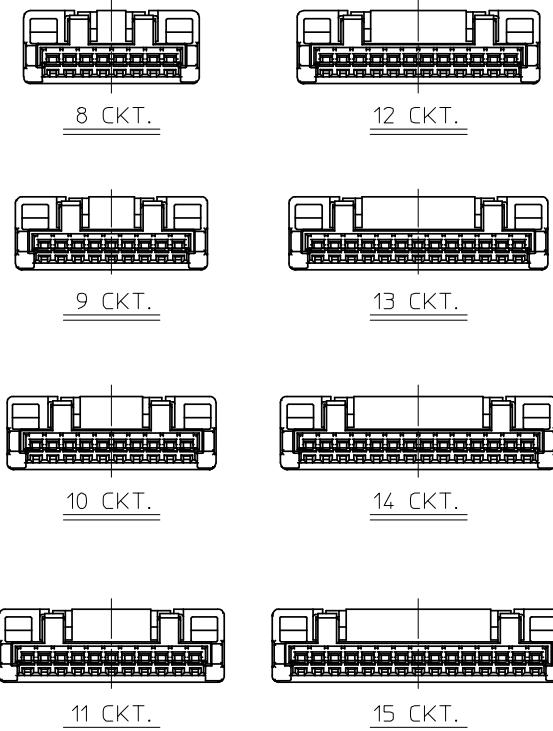

極数の種類 (正面図)
KIND OF CKT. NO. (FRONT VIEW)

20	21.85	502380-1500	15
18.75	20.6	502380-1400	14
17.5	19.35	502380-1300	13
16.25	18.1	502380-1200	12
15	16.85	502380-1100	11
13.75	15.6	502380-1000	10
12.5	14.35	502380-0900	9
11.25	13.1	502380-0800	8
B	A	ポリ袋 POLYBAG PACKAGE オーダー番号 ORDER NO.	極数 CKT. NO.

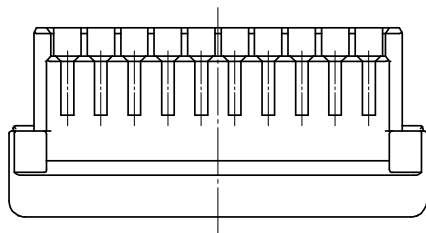

REVISED EC NO: J2008-4410 DRWN:KSETO 2008/06/26 CHKD:KASAKAWA 2008/06/27 APPR: SICHIKAWA 2008/06/27	GENERAL TOLERANCES (UNLESS SPECIFIED)		DIMENSION STYLE MM ONLY		SCALE 5:1	DESIGN UNITS METRIC	THIRD ANGLE PROJECTION	
	10 UNDER	±0.2	DRAWN BY T. MIYAZAKI	DATE 2006/08/28	TITLE 1.25 W/B CONN. SINGLE PLUG HOUSING 8-15CKT.			
	10 OVER 30 UNDER	±0.25	CHECKED BY K. ASAKAWA	DATE 2006/08/28				
	30 OVER	±0.3	APPROVED BY YO. ITO	DATE 2006/08/28	MOLEX INCORPORATED			
	ANGULAR	±3 °	MATERIAL NO.					
DRAFT WHERE APPLICABLE MUST REMAIN WITHIN DIMENSIONS		SEE TABLE		SD-502380-002		1 OF 1		
THIS DRAWING CONTAINS INFORMATION THAT IS PROPRIETARY TO MOLEX INCORPORATED AND SHOULD NOT BE USED WITHOUT WRITTEN PERMISSION								

部品 PART	材質 MATERIAL
ハウジング HOUSING	ポリブチレンテレフタレート UL94V-0 色:白 POLYBUTYLENE TEREPHTHALATE UL94V-0 COLOR:WHITE