

TOSHIBA SCHOTTKY BARRIER RECTIFIER STACK SCHOTTKY BARRIER TYPE

5GWJ2CZ47C

SWITCHING MODE POWER SUPPLY APPLICATION
 CONVERTER & CHOPPER APPLICATION

- Repetitive Peak Reverse Voltage : $V_{RRM} = 40\text{ V}$
- Average Output Rectified Current : $I_O = 5\text{ A}$
- Low Switching Losses and Output Noise

MAXIMUM RATINGS ($T_a = 25^\circ\text{C}$)

CHARACTERISTIC	SYMBOL	RATING	UNIT
Repetitive Peak Reverse Voltage	V_{RRM}	40	V
Repetitive Peak Reverse Surge Voltage (Note 1)	V_{RRSM}	48	V
Average Output Rectified Current	I_O	5	A
Peak One Cycle Surge Forward Current (Sin Wave)	I_{FSM}	50 (50Hz)	A
		55 (60Hz)	
Junction Temperature	T_j	-40~125	$^\circ\text{C}$
Storage Temperature Range	T_{stg}	-40~150	$^\circ\text{C}$
Screw Torque	—	0.6	N·m

Note 1: Pulse Width (t_w) $\leq 500\text{ns}$, duty (t_w / T) $\leq 1 / 25$

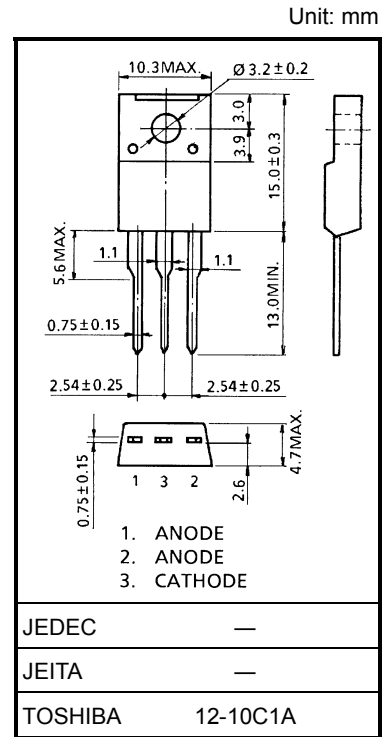

Weight: 2.0 g (typ.)

ELECTRICAL CHARACTERISTICS ($T_a = 25^\circ\text{C}$)

CHARACTERISTIC	SYMBOL	TEST CONDITION	TYP.	MAX	UNIT
Peak Forward Voltage (Note 2)	V_{FM}	$I_{FM} = 2.5\text{A}$	—	0.55	V
Repetitive Peak Reverse Current (Note 2)	I_{RRM}	$V_{RRM} = \text{Rated}$	—	3.5	mA
Junction Capacitance (Note 2)	C_j	$V_R = 10\text{V}$, $f = 1.0\text{MHz}$	100	—	pF
Thermal Resistance	$R_{th(j-c)}$	Total DC, Junction to Case	—	3.5	$^\circ\text{C} / \text{W}$

Note 2: A value applied to one cell.

POLARITY

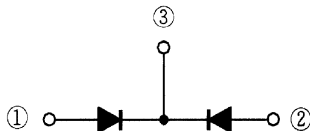

MARKING

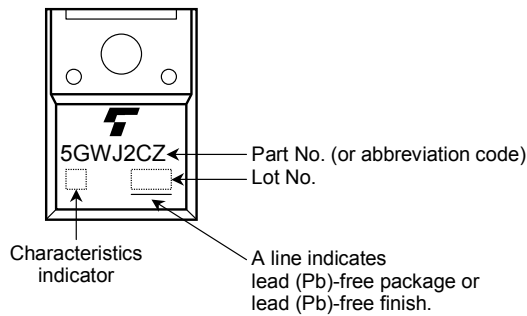

Abbreviation Code	Part No.
5GWJ2CZ	5GWJ2CZ47C

Handling Precaution

Schottky barrier diodes have reverse current characteristics compared to other diodes. There is a possibility SBD may cause thermal runaway when it is used under high temperature or high voltage. Please take forward and reverse loss into consideration during design.

The maximum ratings denote the absolute maximum ratings, which are rated values and must not be exceeded during operation, even for an instant. The following are the general derating methods that we recommend when you design a circuit with a device.

- V_{RRM}:** Use this rating with reference to the above. V_{RRM} has a temperature coefficient of 0.1%/°C. Take this temperature coefficient into account designing a device at low temperature.
- I_O:** We recommend that the worst case current be no greater than 80% of the maximum rating of I_O and T_j be below 100°C. When using this device, take the margin into consideration by using an allowable Tamax-I_O curve.
- I_{FSM}:** This rating specifies the non-repetitive peak current. This is only applied for an abnormal operation, which seldom occurs during the lifespan of the device.
- T_j:** Derate this rating when using a device in order to ensure high reliability. We recommend that the device be used at a T_j of below 100°C.

Please refer to the Rectifiers databook for further information.

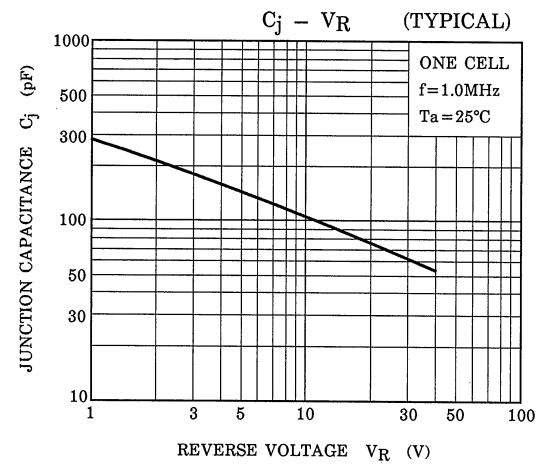
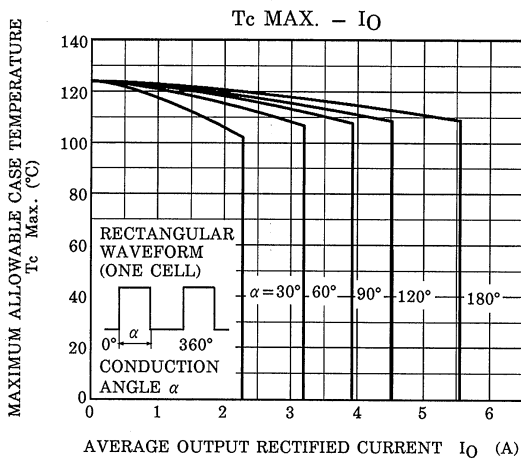
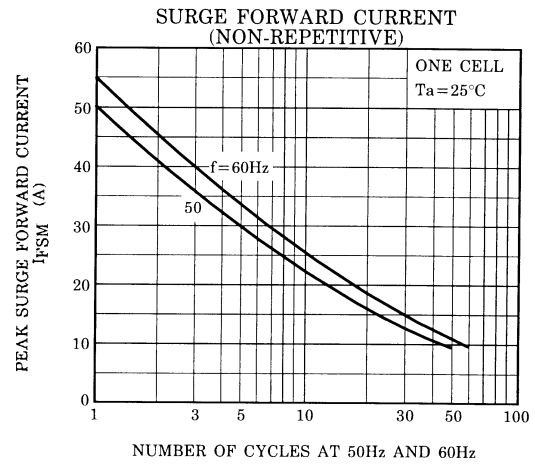
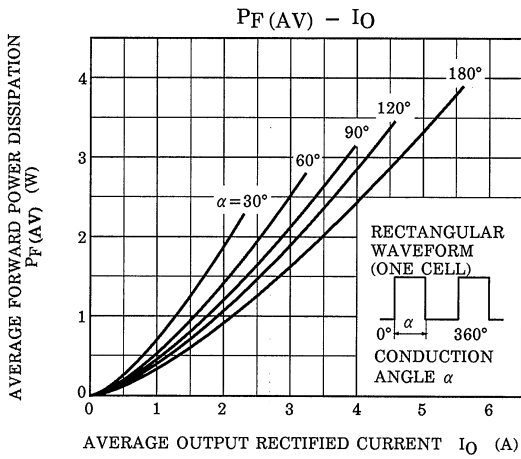
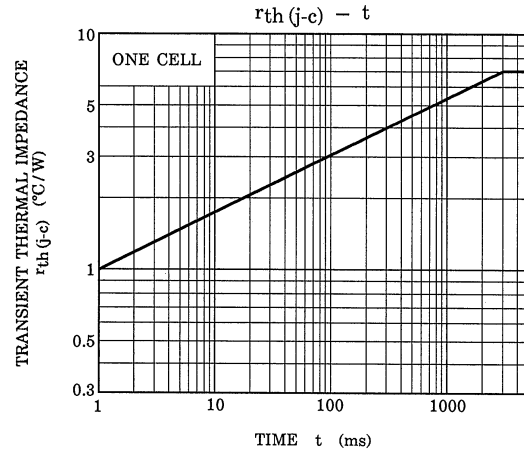
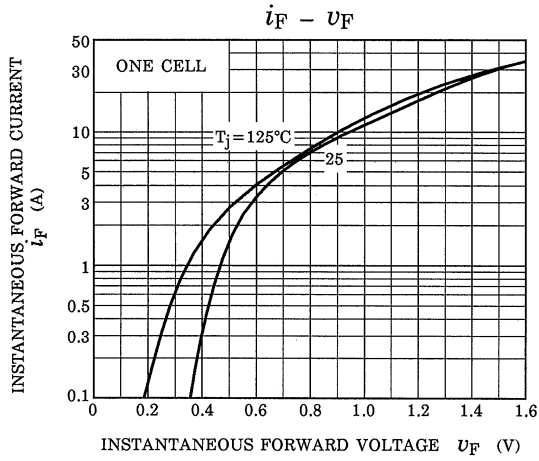

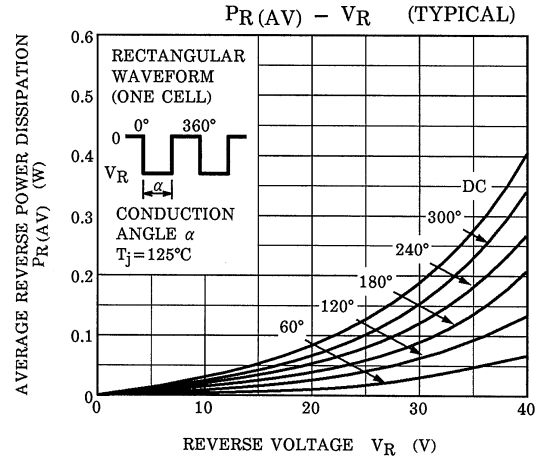
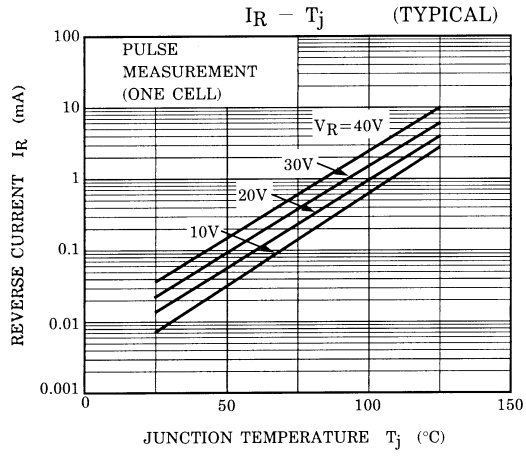

RESTRICTIONS ON PRODUCT USE

030619EAA

- The information contained herein is subject to change without notice.
- The information contained herein is presented only as a guide for the applications of our products. No responsibility is assumed by TOSHIBA for any infringements of patents or other rights of the third parties which may result from its use. No license is granted by implication or otherwise under any patent or patent rights of TOSHIBA or others.
- TOSHIBA is continually working to improve the quality and reliability of its products. Nevertheless, semiconductor devices in general can malfunction or fail due to their inherent electrical sensitivity and vulnerability to physical stress. It is the responsibility of the buyer, when utilizing TOSHIBA products, to comply with the standards of safety in making a safe design for the entire system, and to avoid situations in which a malfunction or failure of such TOSHIBA products could cause loss of human life, bodily injury or damage to property.
In developing your designs, please ensure that TOSHIBA products are used within specified operating ranges as set forth in the most recent TOSHIBA products specifications. Also, please keep in mind the precautions and conditions set forth in the "Handling Guide for Semiconductor Devices," or "TOSHIBA Semiconductor Reliability Handbook" etc..
- The TOSHIBA products listed in this document are intended for usage in general electronics applications (computer, personal equipment, office equipment, measuring equipment, industrial robotics, domestic appliances, etc.). These TOSHIBA products are neither intended nor warranted for usage in equipment that requires extraordinarily high quality and/or reliability or a malfunction or failure of which may cause loss of human life or bodily injury ("Unintended Usage"). Unintended Usage include atomic energy control instruments, airplane or spaceship instruments, transportation instruments, traffic signal instruments, combustion control instruments, medical instruments, all types of safety devices, etc.. Unintended Usage of TOSHIBA products listed in this document shall be made at the customer's own risk.
- TOSHIBA products should not be embedded to the downstream products which are prohibited to be produced and sold, under any law and regulations.