

Amphenol

Telecom Solutions

BNC 31 Series Bayonet Lock RF Connector System

Materials		Electrical			Environmental	
Body/Finish	– Brass/Nickel	Frequency range	50 ohm	75 ohm	Temp. range	– -65°C thru 165°C
Contact			0-4GHz	0-10GHz	Shock	– Consult Rep
Centre MALE	– Brass	Working Voltage 50Hz	500Vrms	500Vrms	Vibration	– Consult Rep
Centre FEMALE	– Phosphor Bronze	Dielectric Withstand	1500V	1500V	Corrosion	– Consult Rep
Centre Finish	– Gold 30µ"	VSWR Straight	1.3 max	1.3 max	Related Information	
Insulator	– Delron/PBT	Right Angle	1.5 max	1.5 max	Hand Tools	– Section F
Gasket	– Silicone Rubber	Resistance Inner	≤3 Milliohms	≤3 Milliohms	Termination Instr.	– Section G
Crimp Ferrules	– Annealed Copper	Outer	2Milliohms	2Milliohms	Terminology	– Section J
Durability	– 500 Cycles	Insulator	≥5000Megaohms	≥5000Megaohms		

Single Crimp Straight Plug					
Termination Instruction E					
50 Ohm			75 Ohm		
B1111x1ND3Gxxx50			B1111x1ND3Gxxx75		
Part Number:	Cable:	Bayonet:	Part Number	Cable:	Bayonet:
31-5896-RFX	RG/U 58/141	Brass	31-71068-RFX	RG/U 59/62	Brass
31-5557-RFX		Diecast			Diecast
31-5897-RFX	Plenum 58/141	Brass	31-71070-RFX		Brass
31-5559-RFX		Diecast			Diecast
31-5898-RFX	RG/U 59/62	Brass	31-71069-RFX		Brass
31-5556-RFX		Diecast			Diecast
31-5899-RFX	Plenum 59/62	Brass	31-71071-RFX	Plenum 59/62	Brass
31-5560-RFX		Diecast			Diecast

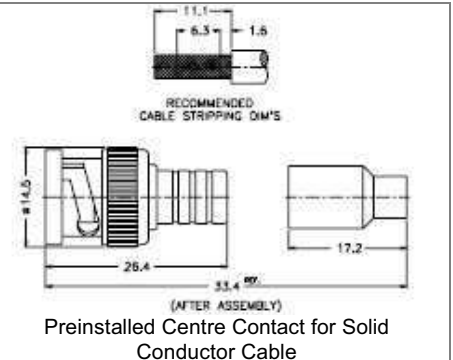

Crimp Straight Plug – Captive Contact					
Termination Instruction E					
50 Ohm			75 Ohm		
B1121x1ND3Gxxx50			B1121x1ND3Gxxx75		
Part Number:	Cable:	Bayonet:	Part Number:	Cable:	Bayonet:
31-320-RFX	RG/U 58/141	Brass	31-71008-RFX	RG/U 59/62	Brass
31-5905-RFX		Diecast			Diecast
31-321-RFX	RG/U 59/62	Brass	31-71072-RFX		Brass
31-5906-RFX		Diecast			Diecast
36650-3RFX	RG/U 58/141	Brass	31-71073-RFX	RG/U 59/62	Brass
31-5908-RFX		Diecast			Diecast
68175-11RFX	RG/U 59/62	Brass	31-71074-RFX		Brass
31-5909-RFX		Diecast			Diecast

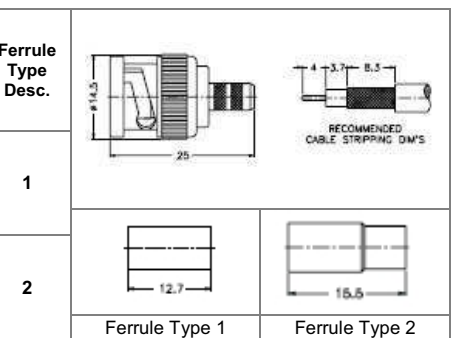

Crimp Straight Plug					
Termination Instruction type 3 - F, type 4 - E, type TPX - G					
50 Ohm			75 Ohm		
B1121x1ND3Gxxx50			B1121x1ND3Gxxx75		
Part Number:	Cable:	Bayonet:	Part Number:	Cable:	Bayonet:
31-315-RFX	RG/U	Brass	31-71013-RFX	RG/U 179/187	Brass
31-5912-RFX		174/188/316			Diecast
31-242-RFX	RG/U 179/187	Brass	31-71075-RFX		Brass
31-5913-RFX		Diecast			Diecast
			31-71077-RFX	RG/U 179/187	Brass
			31-71078-RFX	B1121E9NTPX3Gxxx75	Diecast
31-5915-RFX	RG/U	Brass	31-71076-RFX	RG/U 179/187	Brass
31-5918-RFX		174/188/316			Diecast
31-5916-RFX	RG/U 179/187	Brass	31-71121-RFX		Brass
31-5919-RFX		Diecast			Diecast

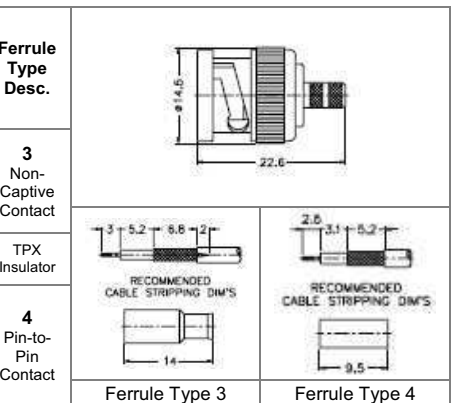

Clamp/Solder Straight Plug					
Termination Instruction type 5 - I, type 6 - H					
50 Ohm			75 Ohm		
B1141x1ND3Gxxx50			B1141x1ND3Gxxx75		
Part Number:	Cable:	Bayonet:	Part Number:	Cable:	Bayonet:
31-5966-RFX	RG/U 58/141	Brass	31-71105-RFX	RG/U 59/62	Brass
31-301-RFX		Diecast			Diecast
31-5968-RFX	Plenum 58/141	Brass	31-71107-RFX		Brass
31-5970-RFX		Diecast			Diecast
31-5967-RFX	RG/U 59/62	Brass	31-71106-RFX	Plenum 59/62	Brass
31-304-RFX		Diecast			Diecast
31-5969-RFX	Plenum 59/62	Brass	31-71108-RFX		Brass
31-5971-RFX		Diecast			Diecast
31-2-RFX	RG/U 58/141	Brass	31-71109-RFX	RG/U 59/62	Brass
31-5972-RFX		Diecast			Diecast
31-212-RFX	RG/U 59/62	Brass	31-71110-RFX		Brass
31-5973-RFX		Diecast			Diecast

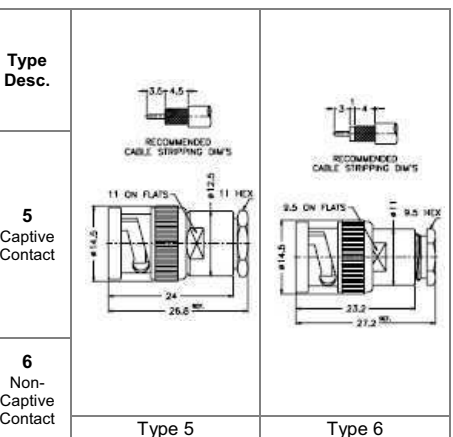

ARFA/RF

Amphenol

Telecom Solutions

BNC 31 Series Bayonet Lock RF Connector System – Continued

Twist-On Straight Plug for Solid Centre Conductor					
Termination Instruction K					
50 Ohm			75 Ohm		
Part Number:	Cable:	Bayonet:	Part Number:	Cable:	Bayonet:
B1131x1ND3Gxxx50					
31-5137-RFX	RG/U 58/141	Brass	Consult Representative		
31-5960-RFX		Diecast			
31-5962-RFX	Plenum 58/141	Brass			
31-5964-RFX		Diecast			
31-5136-RFX	RG/U 59/62	Brass			
31-5961-RFX		Diecast			
31-5963-RFX	Plenum 59/62	Brass			
31-5369-RFX		Diecast			

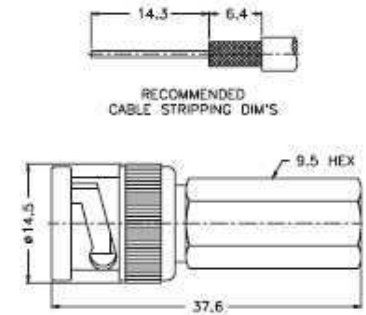

Solder Straight Plug for Semi-Rigid Cable					
Termination Instruction S					
50 Ohm			75 Ohm		
Part Number:	Cable:	Bayonet:	Part Number:	Cable:	Bayonet:
B1181A1NT3Gxxx50					
31-5934-RFX	.085" A:2.2 B:3.0	Brass	Consult Representative		
31-5933-RFX	.141" A:3.6 B:4.6	Brass Diecast			

On Request

Crimp Right Angle Plug					
Termination Instruction E					
50 Ohm			75 Ohm		
Part Number:	Cable:	Bayonet:	Part Number:	Cable:	Bayonet:
B1112x1ND3Gxxx50			B1112x1ND3Gxxx75		
31-5911-RFX	RG/U 58/141	Brass	31-71083-RFX	RG/U 59/62	Brass
31-5917-RFX		Diecast			Diecast
31-5914-RFX	RG/U 59/62	Brass	31-71084-RFX	Plenum 59/62	Brass
31-5920-RFX		Diecast			Diecast
31-5921-RFX	Plenum 58/141	Brass	31-71085-RFX	Plenum 59/62	Brass
31-5923-RFX		Diecast			Diecast
31-5922-RFX	Plenum 59/62	Brass	31-71086-RFX	RG/U 179/187	Brass
31-5924-RFX		Diecast			Diecast
31-5925-RFX	RG/U 174/179/ 187/188/316	Brass	31-71087-RFX	RG/U 179/187	Brass
31-5926-RFX		Diecast			Diecast

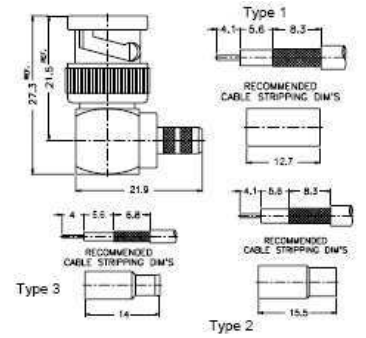

Crimp Right Angle Long Body Plug						
Termination Instruction type 4/5 - E, type 6 - F						
50 Ohm			75 Ohm			
Part Number:	Cable:	Bayonet:	Part Number:	Cable:	Bayonet:	
B1112x1ND3Gxxx50			B1122x1ND3Gxxx75			
31-335-RFX	RG/U 58/141	Brass	31-71010-RFX	RG/U 59/62	Brass	
31-5927-RFX		Diecast			Diecast	
31-336-RFX		Brass			31-71089-RFX	Brass
31-5928-RFX		Diecast				
31-5929-RFX		Brass			31-71090-RFX	Brass
31-5231-RFX		Diecast				
31-5930-RFX		Brass			31-71091-RFX	Diecast
31-5932-RFX	Diecast	Diecast				
31-5991-RFX	RG/U 179/187	Brass	31-71101-RFX	RG/U 179/187	Brass	
31-316-RFX		Diecast			Diecast	
31-5992-RFX		Brass			31-71015-RFX	Diecast
31-243-RFX		Diecast				

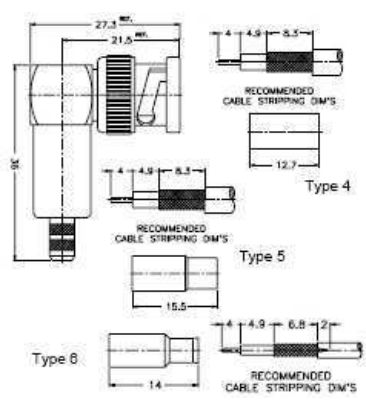

Crimp Straight Jack					
Termination Instruction type 7/8 - E, type 9 - F					
50 Ohm			75 Ohm		
Part Number:	Cable:	Contact/Insul:	Part Number:	Cable:	Contact/Insul:
B6121x1Nx3Gxxx50			B6121x1Nx3Gxxx75		
31-327-RFX	RG/U 58/141	Captive/Teflon	31-71079-RFX	RG/U 59/62	Captive/Teflon
36800-RFX		Non-Cap/Delrin			Non-Cap/Delrin
31-328-RFX	RG/U 59/62	Captive/Teflon	31-71009-RFX	Plenum 59/62	Captive/Teflon
68150-RFX		Non-Cap/Delrin			Non-Cap/Delrin
31-5901-RFX	Plenum 58/141	Captive/Teflon	31-71080-RFX	Plenum 59/62	Captive/Teflon
31-5903-RFX		Non-Cap/Delrin			Non-Cap/Delrin
31-5902-RFX	Plenum 59/62	Captive/Teflon	31-71081-RFX	RG/U 179/187	Captive/Teflon
31-5904-RFX		Non-Cap/Delrin			Non-Cap/Delrin
31-317-RFX	RG/U 174/188/316	Non-Cap/Delrin	31-71014-RFX	RG/U 179/187	Non-Cap/Delrin
31-244-RFX	RG/U 179/187				

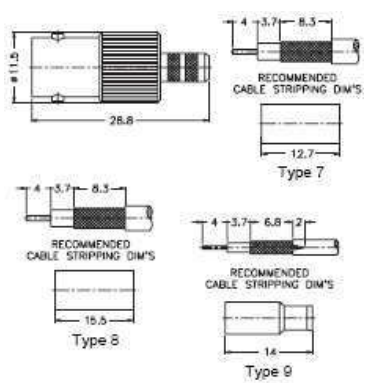

Amphenol

Telecom Solutions

BNC 31 Series Bayonet Lock RF Connector System – Continued

Crimp Straight Pin-to-Pin Jack					
Termination Instruction type E					
50 Ohm			75 Ohm		
Part Number:	Cable:	Contact/Insul:	Part Number:	Cable:	Contact/Insul:
B6121AG1ND3Gxxx50			B6121AG1ND3Gxxx75		
31-5907-RFX	RG/U 174/188/316	Delrin	31-71082-RFX	RG/U 179/187	Delrin
31-5910-RFX	RG/U 179/187				

Crimp Straight Bulkhead Jack					
Termination Instruction E					
50 Ohm			75 Ohm		
Part Number:	Cable:	Contact/Insul:	Part Number:	Cable:	Contact/Insul:
B6421xNx3Gxxx50			B6421xNx3Gxxx75		
31-5935-RFX	RG/U	Captive/Teflon	31-71092-RFX	RG/U 59/62	Captive/Teflon
31-342-RFX	58/141	Non-Cap/Delrin			Non-Cap/Delrin
31-5936-RFX	RG/U 59/62	Captive/Teflon			31-71011-RFX
31-5937-RFX	RG/U	Captive/Teflon	31-71093-RFX	RG/U 59/62	Captive/Teflon
31-5939-RFX	58/141	Non-Cap/Delrin			Non-Cap/Delrin
31-5938-RFX	RG/U 59/62	Captive/Teflon			31-71094-RFX
31-5940-RFX	RG/U	Captive/Teflon	31-71095-RFX	RG/U 59/62	Captive/Teflon
31-5941-RFX	58/141	Non-Cap/Delrin			Non-Cap/Delrin
31-5942-RFX	RG/U 59/62	Captive/Teflon			31-71096-RFX
31-5944-RFX	RG/U 59/62	Captive/Teflon	31-71097-RFX	RG/U 59/62	Captive/Teflon
31-5945-RFX	RG/U	Non-Cap/Delrin			Non-Cap/Delrin
31-5947-RFX	58/141	Captive/Teflon			31-71098-RFX
31-5946-RFX	RG/U 59/62	Captive/Teflon			
31-5948-RFX	RG/U 59/62	Non-Cap/Delrin			

Crimp/Crimp Straight Bulkhead Jack					
Termination Instruction Ferrule 3 - F, Ferrule 4 - E					
50 Ohm			75 Ohm		
Part Number:	Cable:	Contact/Insul:	Part Number:	Cable:	Contact/Insul:
B6421x1ND3Gxxx50			B6421x1ND3Gxxx75		
31-318-RFX	RG/U 174/188/316	Non-Cap/Delrin	31-71016-RFX	RG/U 179/187	Non-Cap/Delrin
31-245-RFX	RG/U 179/187				
31-5949-RFX	RG/U 174/188/316	Pin-to-Pin/Delrin	Consult Representative		

Crimp/Crimp Straight Bulkhead Jack Isolated from Ground					
Termination Instruction E					
50 Ohm			75 Ohm		
Part Number:	Cable:	Contact/Insul:	Part Number:	Cable:	Contact/Insul:
B6721x1Nx3Gxxx50			B6721x1Nx3Gxxx75		
31-5950-RFX	RG/U	Captive/Teflon	31-71099-RFX	RG/U 59/62	Captive/Teflon
31-5952-RFX	58/141	Non-Cap/Delrin			Non-Cap/Delrin
31-5951-RFX	RG/U 59/62	Captive/Teflon	31-71100-RFX	RG/U 59/62	Non-Cap/Delrin
31-5953-RFX	RG/U 59/62	Non-Cap/Delrin			Captive/Teflon
31-5954-RFX	RG/U	Captive/Teflon			31-71102-RFX
31-5990-RFX	58/141	Non-Cap/Delrin	31-71103-RFX	RG/U 59/62	Captive/Teflon
31-5955-RFX	RG/U 59/62	Captive/Teflon			Non-Cap/Delrin
31-5956-RFX	RG/U 59/62	Non-Cap/Delrin			
31-5957-RFX	RG/U 174/188/316	Non-Cap/Delrin	31-5959-RFX	RG/U 179/187	Non-Cap/Delrin
31-5958-RFX	RG/U 179/187				

Twist-On Straight Jack for Solid Centre Conductor					
Termination Instruction K					
50 Ohm			75 Ohm		
Part Number:	Cable:	Bayonet:	Part Number:	Cable:	Bayonet:
B6131A1ND3Gxxx50					
31-5139-RFX	RG/U 58/141	Brass	Consult Representative		
31-5965-RFX	Plenum 58/141	Diecast			
31-5138-RFX	RG/U 59/62	Brass			
31-5370-RFX	Plenum 59/62	Diecast			

ARFA/RP

BNC 31 Series Bayonet Lock RF Connector System – Continued

Clamp/Solder Straight Jack					
Termination Instruction type I					
50 Ohm			75 Ohm		
B6141A1ND3Gxxx50			B6141A1ND3Gxxx75		
Part Number:	Cable:	Insulator:	Part Number	Cable:	Contact/Insul:
31-5-RFX	RG/U 58/141	Delrin	31-71111-RFX	RG/U 59/62	Delrin
31-5974-RFX	Plenum 58/141		31-71112-RFX	Plenum 59/62	
31-15-RFX	RG/U 59/62				
31-5975-RFX	Plenum 59/62				

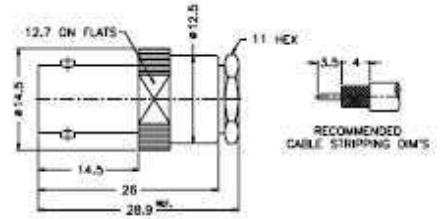

Solder-Terminal Types - Straight Bulkhead Jack					
50 Ohm			75 Ohm		
Part Number:	Description:	Part Number:	Description:	Figure	
31-203-RFX	4-Hole Flange Mount Teflon Insulator B6551A1NT3G50	31-71104-RFX	4-Hole Flange Mount Teflon Insulator B6551A1NT3G75	Fig 1	
31-221-RFX	Solder-Pot L1:3.2mm L:26.7mm B6351xxNDxx50	31-221-75RFX	Solder-Pot L1:3.2mm L:26.7mm B6351xxNDxx75	Fig 2	
31-5977-RFX	Solder-Pot L1:6.5mm L:30.0mm B6351xxNDxx50	31-5977-75RFX	Solder-Pot L1:6.5mm L:30.0mm B6351xxNDxx75	Fig 2	
31-5978-RFX	Solder-Pot L1:9.5mm L:33.0mm B6351xxNDxx50	31-5978-75RFX	Solder-Pot L1:9.5mm L:33.0mm B6351xxNDxx75	Fig 2	
31-10-RFX	Solder-Pot Isolated from Ground L1: 3.2mm L:30mm B6651B1NNYL3G50	31-10-75RFX	Solder-Pot Isolated from Ground L1: 3.2mm L:30mm B6651B1NNYL3G75	Fig 3	<p style="text-align: center; font-size: 1.2em;">Missing Eyelet</p>
31-2221-RFX	Solder-Tab with Eyelet B6351xxNDxx50	31-2221-75RFX	Solder-Tab with Eyelet B6351xxNDxx75	Fig 3	

PCB Mount Jacks					
50 Ohm			75 Ohm		
Part Number:	Description:	Part Number:	Description:	Figure	
B6251xxNx3G50			B6251xxNx3G75		
31-597650-RFX	Straight Low Profile L:11.7 PCB Layout A	31-5976-75RFX	Straight Low Profile L:11.7 PCB Layout A	Fig 4	
31-18225-RFX	Straight Low Profile L:10.8 PCB Layout C	31-18225-75RFX	Straight Low Profile L:10.8 PCB Layout C	Fig 4	
31-5158-RFX	Straight 3 Peg PCB Layout B	31-5158-75RFX	Straight 3 Peg PCB Layout B	Fig 5	
31-5493-RFX	Straight Plastic White Bulkhead	31-71058-RFX	Straight Plastic White Bulkhead	Fig 5	
31-5539-RFX	Straight Plastic Black Bulkhead	31-71059-RFX	Straight Plastic Black Bulkhead	Fig 6	
B6252HxNPP3G50			B6252HxNPP3G75		
31-543110-RFX	R/A Plastic White L:15.88mm Bulkhead PCB Layout E	31-71047-10RFX	R/A Plastic White L:15.88mm Bulkhead PCB	Fig 6	
31-553810-RFX	R/A Plastic Black L:15.88mm Bulkhead PCB Layout E	31-71046-10RFX	R/A Plastic Black L:15.88mm Bulkhead PCB Layout E	Fig 6	
31-548610-RFX	R/A Plastic White L:13.1mm Bulkhead PCB Layout E	31-71052-10RFX	R/A Plastic White L:13.1mm Bulkhead PCB Layout E	Like Fig 6	
31-554010-RFX	R/A Plastic Black L:13.1mm Bulkhead PCB Layout E	31-71053-10RFX	R/A Plastic Black L:13.1mm Bulkhead PCB Layout E	Like Fig 6	
31-5640-RFX	R/A Commercial Metal L:15.88mm Bulkhead PCB Layout E	31-71043-RFX	R/A Commercial Metal L:15.88mm Bulkhead PCB Layout E	Like Fig 6	
31-5637-RFX	R/A Commercial Metal L:13.1mm Bulkhead PCB Layout E	31-71042-RFX	R/A Commercial Metal L:13.1mm Bulkhead PCB Layout E	Like Fig 6	
G11A0299	R/A Seamless Metal Fig 7 PCB Layout F	Consult Representative			

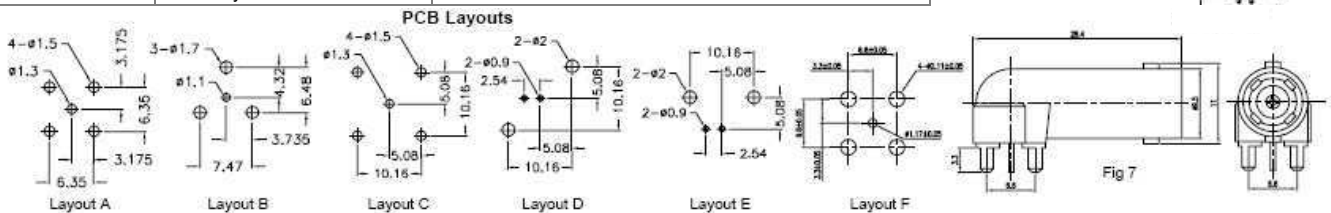

PCB Layouts

Amphenol

Telecom Solutions

BNC 31 Series Bayonet Lock RF Connector System – Continued

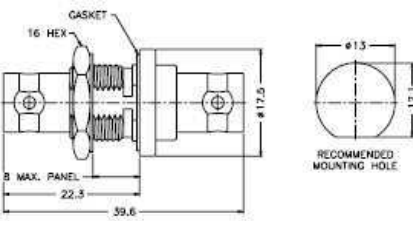
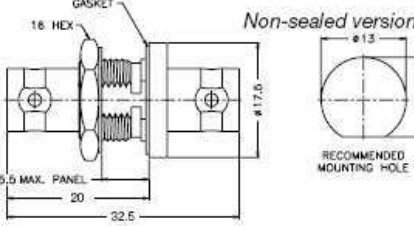
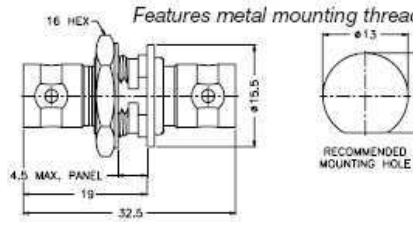
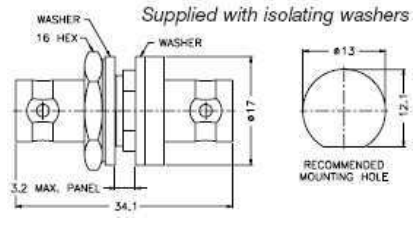
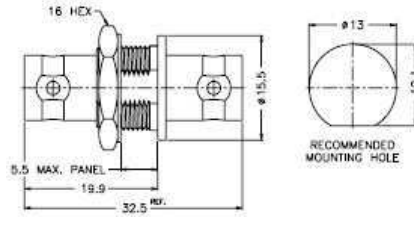
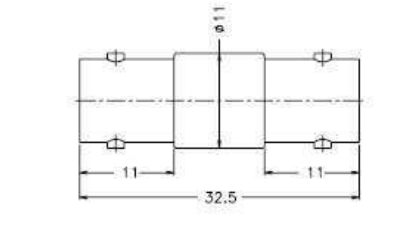
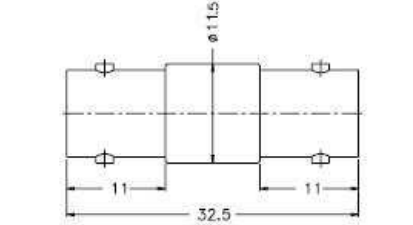
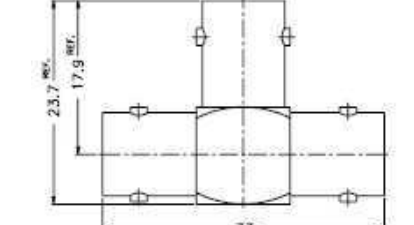
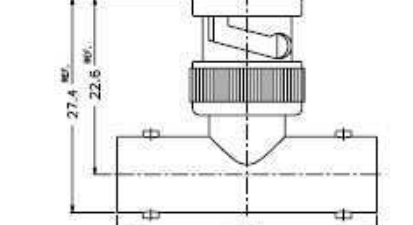
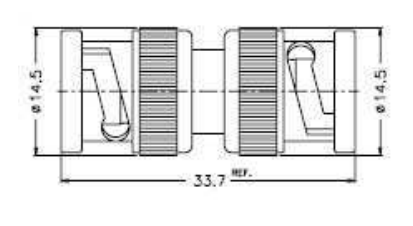
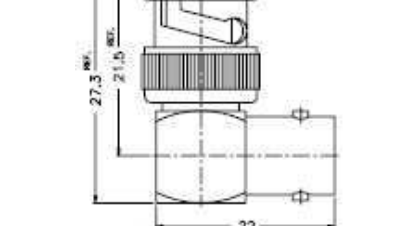
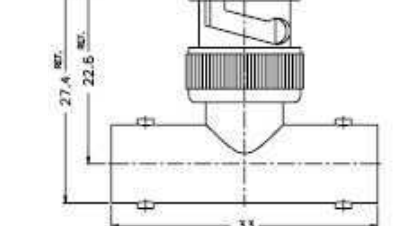
 <p style="text-align: center;">Jack-to-Jack Bulkhead Straight Adapter 8mm Panel <small>B7471A1ND3Gxx</small></p>	 <p style="text-align: center;">Jack-to-Jack Bulkhead Straight Adapter 5.5mm Panel <small>B7471B1ND3Gxx</small></p>	 <p style="text-align: center;">Jack-to-Jack Bulkhead Straight Adapter Isolated from Ground 4.5mm Panel <small>B7771B1ND3Gxx</small></p>																														
<table border="1" style="width: 100%; border-collapse: collapse;"> <thead> <tr> <th style="width: 15%;">Part Number:</th> <th style="width: 85%;">Description:</th> </tr> </thead> <tbody> <tr> <td>31-220G-RFX</td> <td>50 Ohm</td> </tr> <tr> <td>31220G-75RFX</td> <td>75 Ohm</td> </tr> </tbody> </table>	Part Number:	Description:	31-220G-RFX	50 Ohm	31220G-75RFX	75 Ohm	<table border="1" style="width: 100%; border-collapse: collapse;"> <thead> <tr> <th style="width: 15%;">Part Number:</th> <th style="width: 85%;">Description:</th> </tr> </thead> <tbody> <tr> <td>31-220N-RFX</td> <td>50 Ohm</td> </tr> <tr> <td>31-220N-75RFX</td> <td>75 Ohm</td> </tr> </tbody> </table>	Part Number:	Description:	31-220N-RFX	50 Ohm	31-220N-75RFX	75 Ohm	<table border="1" style="width: 100%; border-collapse: collapse;"> <thead> <tr> <th style="width: 15%;">Part Number:</th> <th style="width: 85%;">Description:</th> </tr> </thead> <tbody> <tr> <td>31-5979-RFX</td> <td>50 Ohm</td> </tr> <tr> <td>31-71113-RFX</td> <td>75 Ohm</td> </tr> </tbody> </table>	Part Number:	Description:	31-5979-RFX	50 Ohm	31-71113-RFX	75 Ohm												
Part Number:	Description:																															
31-220G-RFX	50 Ohm																															
31220G-75RFX	75 Ohm																															
Part Number:	Description:																															
31-220N-RFX	50 Ohm																															
31-220N-75RFX	75 Ohm																															
Part Number:	Description:																															
31-5979-RFX	50 Ohm																															
31-71113-RFX	75 Ohm																															
 <p style="text-align: center;">Jack-to-Jack Bulkhead Straight Adapter Isolated from Ground 3.2mm Panel <small>B7771B2NPBT3Gxx</small></p>	 <p style="text-align: center;">Jack-to-Jack Bulkhead Straight Adapter Isolated from Ground 5.5mm Panel <small>B7771B3ND3Gxx</small></p>	 <p style="text-align: center;">Jack-to-Jack Straight Adapter <small>B7071A1ND3Gxx</small></p>																														
<table border="1" style="width: 100%; border-collapse: collapse;"> <thead> <tr> <th style="width: 15%;">Part Number:</th> <th style="width: 85%;">Description:</th> </tr> </thead> <tbody> <tr> <td>31-5980-RFX</td> <td>50 Ohm</td> </tr> <tr> <td>31-71114-RFX</td> <td>75 Ohm</td> </tr> </tbody> </table>	Part Number:	Description:	31-5980-RFX	50 Ohm	31-71114-RFX	75 Ohm	<table border="1" style="width: 100%; border-collapse: collapse;"> <thead> <tr> <th style="width: 15%;">Part Number:</th> <th style="width: 85%;">Description:</th> </tr> </thead> <tbody> <tr> <td>31-4803-RFX</td> <td>50 Ohm</td> </tr> <tr> <td>31-4803-75RFX</td> <td>75 Ohm</td> </tr> </tbody> </table>	Part Number:	Description:	31-4803-RFX	50 Ohm	31-4803-75RFX	75 Ohm	<table border="1" style="width: 100%; border-collapse: collapse;"> <thead> <tr> <th style="width: 15%;">Part Number:</th> <th style="width: 85%;">Description:</th> </tr> </thead> <tbody> <tr> <td>31-219-RFX</td> <td>50 Ohm</td> </tr> <tr> <td>31-219-75</td> <td>75 Ohm</td> </tr> </tbody> </table>	Part Number:	Description:	31-219-RFX	50 Ohm	31-219-75	75 Ohm												
Part Number:	Description:																															
31-5980-RFX	50 Ohm																															
31-71114-RFX	75 Ohm																															
Part Number:	Description:																															
31-4803-RFX	50 Ohm																															
31-4803-75RFX	75 Ohm																															
Part Number:	Description:																															
31-219-RFX	50 Ohm																															
31-219-75	75 Ohm																															
 <p style="text-align: center;">Jack-to-Jack Straight Adapter <small>B7071A1ND3Gxx</small></p>	 <p style="text-align: center;">Jack-to-Jack-to-Jack Tee Adapter <small>B8073A1ND3Gxx</small></p>	 <p style="text-align: center;">Jack-to-Plug-to-Jack Tee Adapter <small>B9073D1ND3G50</small></p>																														
<table border="1" style="width: 100%; border-collapse: collapse;"> <thead> <tr> <th style="width: 15%;">Part Number:</th> <th style="width: 85%;">Description:</th> </tr> </thead> <tbody> <tr> <td>31-5981-RFX</td> <td>50 Ohm</td> </tr> <tr> <td>31-71115-RFX</td> <td>75 Ohm</td> </tr> </tbody> </table>	Part Number:	Description:	31-5981-RFX	50 Ohm	31-71115-RFX	75 Ohm	<table border="1" style="width: 100%; border-collapse: collapse;"> <thead> <tr> <th style="width: 15%;">Part Number:</th> <th style="width: 85%;">Description:</th> </tr> </thead> <tbody> <tr> <td>31-5984-RFX</td> <td>50 Ohm</td> </tr> <tr> <td>31-71118-RFX</td> <td>75 Ohm</td> </tr> </tbody> </table>	Part Number:	Description:	31-5984-RFX	50 Ohm	31-71118-RFX	75 Ohm	<table border="1" style="width: 100%; border-collapse: collapse;"> <thead> <tr> <th style="width: 15%;">Part Number:</th> <th style="width: 85%;">Description:</th> </tr> </thead> <tbody> <tr> <td>31-208-RFX</td> <td>50 Ohm</td> </tr> </tbody> </table>	Part Number:	Description:	31-208-RFX	50 Ohm														
Part Number:	Description:																															
31-5981-RFX	50 Ohm																															
31-71115-RFX	75 Ohm																															
Part Number:	Description:																															
31-5984-RFX	50 Ohm																															
31-71118-RFX	75 Ohm																															
Part Number:	Description:																															
31-208-RFX	50 Ohm																															
 <p style="text-align: center;">Plug-to-Plug Straight Adapter <small>B2071x2ND3Gxx</small></p>	 <p style="text-align: center;">Plug-to-Jack Right Angle Adapter <small>B5072x1ND3Gxx</small></p>	 <p style="text-align: center;">Jack-to-Plug-to-Jack Tee Adapter <small>B9073x1ND3Gxx</small></p>																														
<table border="1" style="width: 100%; border-collapse: collapse;"> <thead> <tr> <th style="width: 15%;">Part Number:</th> <th style="width: 85%;">Description:</th> </tr> </thead> <tbody> <tr> <td>31-218-RFX</td> <td>50 Ohm Brass Bayonet</td> </tr> <tr> <td>31-218-RFXD</td> <td>50 Ohm Diecast Bayonet</td> </tr> <tr> <td>21-218-75RFX</td> <td>75 Ohm Brass Bayonet</td> </tr> <tr> <td>31-71116-RFX</td> <td>75 Ohm Diecast Bayonet</td> </tr> </tbody> </table>	Part Number:	Description:	31-218-RFX	50 Ohm Brass Bayonet	31-218-RFXD	50 Ohm Diecast Bayonet	21-218-75RFX	75 Ohm Brass Bayonet	31-71116-RFX	75 Ohm Diecast Bayonet	<table border="1" style="width: 100%; border-collapse: collapse;"> <thead> <tr> <th style="width: 15%;">Part Number:</th> <th style="width: 85%;">Description:</th> </tr> </thead> <tbody> <tr> <td>31-5983-RFX</td> <td>50 Ohm Brass Bayonet</td> </tr> <tr> <td>31-9-RFX</td> <td>50 Ohm Diecast Bayonet</td> </tr> <tr> <td>31-71117-RFX</td> <td>75 Ohm Brass Bayonet</td> </tr> <tr> <td>31-9-75RFX</td> <td>75 Ohm Diecast Bayonet</td> </tr> </tbody> </table>	Part Number:	Description:	31-5983-RFX	50 Ohm Brass Bayonet	31-9-RFX	50 Ohm Diecast Bayonet	31-71117-RFX	75 Ohm Brass Bayonet	31-9-75RFX	75 Ohm Diecast Bayonet	<table border="1" style="width: 100%; border-collapse: collapse;"> <thead> <tr> <th style="width: 15%;">Part Number:</th> <th style="width: 85%;">Description:</th> </tr> </thead> <tbody> <tr> <td>31-5985-BRFX</td> <td>50 Ohm Brass Bayonet</td> </tr> <tr> <td>31-5986-RFX</td> <td>50 Ohm Diecast Bayonet</td> </tr> <tr> <td>31-71119-RFX</td> <td>75 Ohm Brass Bayonet</td> </tr> <tr> <td>31-71120-RFX</td> <td>75 Ohm Diecast Bayonet</td> </tr> </tbody> </table>	Part Number:	Description:	31-5985-BRFX	50 Ohm Brass Bayonet	31-5986-RFX	50 Ohm Diecast Bayonet	31-71119-RFX	75 Ohm Brass Bayonet	31-71120-RFX	75 Ohm Diecast Bayonet
Part Number:	Description:																															
31-218-RFX	50 Ohm Brass Bayonet																															
31-218-RFXD	50 Ohm Diecast Bayonet																															
21-218-75RFX	75 Ohm Brass Bayonet																															
31-71116-RFX	75 Ohm Diecast Bayonet																															
Part Number:	Description:																															
31-5983-RFX	50 Ohm Brass Bayonet																															
31-9-RFX	50 Ohm Diecast Bayonet																															
31-71117-RFX	75 Ohm Brass Bayonet																															
31-9-75RFX	75 Ohm Diecast Bayonet																															
Part Number:	Description:																															
31-5985-BRFX	50 Ohm Brass Bayonet																															
31-5986-RFX	50 Ohm Diecast Bayonet																															
31-71119-RFX	75 Ohm Brass Bayonet																															
31-71120-RFX	75 Ohm Diecast Bayonet																															

ARFA/RF

Amphenol

Telecom Solutions

BNC 31 Series Bayonet Lock RF Connector System – Continued

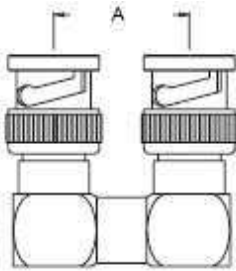
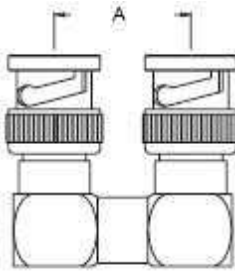
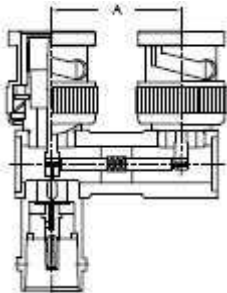
 <p>Plug-to-Plug Adapter U-Link</p>		 <p>Plug-to-Plug Adapter U-Link</p>		 <p>Plug-to-Jack-to-Plug Adapter U-Link with Tap</p>	
Part Number:	Description:	Part Number:	Description:	Part Number:	Description:
B2076A1002-NT50G-50	50 Ohm	B2076A1003-NT3G-75	75 Ohm (A) 18.5mm	B4070A2-ND3G-75	75 Ohm (A) 20mm
		B2076A1001-NT3G-75	75 Ohm (A) 20.6mm	B4070A3-ND3G-75	75 Ohm (A) 20.6mm
		B2076A1004-NT3G-75	75 Ohm (A) 25mm	B4070A1-ND3G-75	75 Ohm (A) 30mm
		B2076A1-NT3G-75	75 Ohm (A) 30mm		

BNC Patch Panels With Jack to Jack Bulkhead Adapters



Part Number:	Description:
AC-BNC20MJ75	20 way/Supplied with strip ID labels

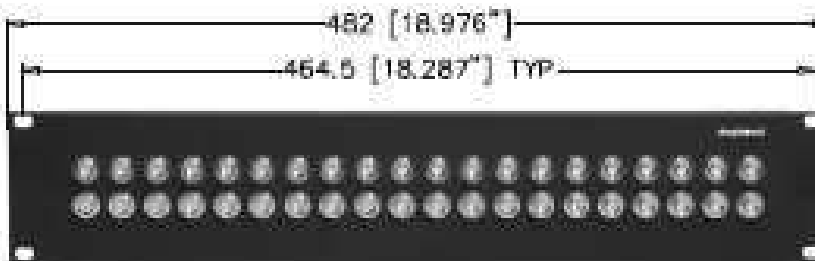

Part Number:	Description:
AC-BNC40MJ75	40 way/Supplied with strip ID labels