

Features

- Fully encapsulated
- Low profile
- Low insertion loss
- Frequency range 10 kHz to 500 MHz
- Impedance levels from 12.5 Ω to 800 Ω (nominal 50 Ω)
- 6 pin DIP and SMD
- Lead free
- RoHS compliant**

RF2, RF3, RF4 Series - Wideband Transformers

Electrical Specifications @ 25 °C

Type D	Part Number Type W	Type J	Ratio Impedance	Frequency MHz	Insertion Loss			Schematic
					3dB MHz	2dB MHz	1dB MHz	
2-1-1D_	2-1-1W_	2-1-1J_	1	.050-200	.050-200	.080-150	.20-80	<p style="text-align: center;">RF2 Series</p>
2-1-6D_	2-1-6W_	2-1-6J_	1	.003-300	.003-300	.010-150	.02-50	
2-2-1D_	2-2-1W_	2-2-1J_	2	.070-200	.070-200	.100-100	.50-50	
2-2.5-6D_	2-2.5-6W_	2-2.5-6J_	2.5	.010-100	.010-100	.020-50	.05-20	
2-3-1D_	2-3-1W_	2-3-1J_	3	.050-250	.050-250	.100-200	.50-70	
2-4-1D_	2-4-1W_	2-4-1J_	4	.200-350	.200-350	.350-300	2-100	
2-4-6D_	2-4-6W_	2-4-6J_	4	.020-250	.020-250	.050-150	.10-100	
2-5-1D_	2-5-1W_	2-5-1J_	5	.300-300	.300-300	.600-200	5-100	
2-8-1D_	2-8-1W_	2-8-1J_	8	.030-140	.030-140	.100-90	1-60	
2-13-1D_	2-13-1W_	2-13-1J_	13	.300-120	.300-120	.700-80	5-20	
2-16-6D_	2-16-6W_	2-16-6J_	16	.030-75	.030-75	.060-30	10-20	
3-1-1D_	3-1-1W_	3-1-1J_	1	.150-400	.150-400	.350-200	2-50	
3-1-6D_	3-1-6W_	3-1-6J_	1	.010-150	.010-150	.020-100	.05-50	
3-1.5-1D_	3-1.5-1W_	3-1.5-1J_	1.5	.100-300	.100-300	.200-150	.50-80	
3-1.5-6D_	3-1.5-6W_	3-1.5-6J_	1.5	.020-100	.020-100	.050-50	.10-25	
3-2.5-6D_	3-2.5-6W_	3-2.5-6J_	2.5	.010-100	.010-100	.020-50	.05-20	
3-4-6D_	3-4-6W_	3-4-6J_	4	.020-200	.020-200	.050-150	.10-100	
3-9-1D_	3-9-1W_	3-9-1J_	9	.150-200	.150-200	.300-150	2-40	
3-16-1D_	3-16-1W_	3-16-1J_	16	.300-120	.300-120	.700-80	.50-20	
3-36-1D_	3-36-1W_	3-36-1J_	36	.030-20	.030-20	.050-10	.10-5	
4-1-6D_	4-1-6W_	4-1-6J_	1	.004-500	.004-500	.020-200	.10-50	<p style="text-align: center;">RF4 Series</p>
4-1.5-1D_	4-1.5-1W_	4-1.5-1J_	1.5	.075-500	.075-500	.200-100	.10-50	
4-2.5-6D_	4-2.5-6W_	4-2.5-6J_	2.5	.010-50	.010-50	.025-25	.05-10	
4-4-1D_	4-4-1W_	4-4-1J_	4	.050-200	.050-200	.200-50	1-30	
4-25-1D_	4-25-1W_	4-25-1J_	25	.020-30	.020-30	.050-20	.10-10	

Note:

RF2 and RF3 are standard units. RF4 only on request.

Terminal Material: 97Sn/2.5Cu/0.5Ag

Operating Temperature Range: 0 °C to +70 °C

Storage Temperature Range: -40 °C to +85 °C

RF2, RF3, RF4 Series - Wideband Transformers



Product Dimensions

Type D

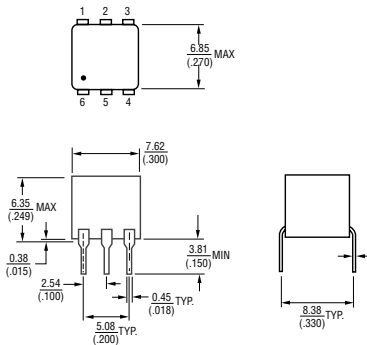

Type J

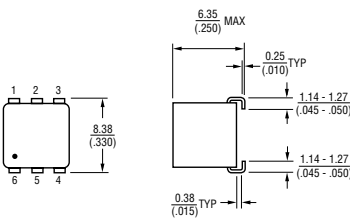

Type W

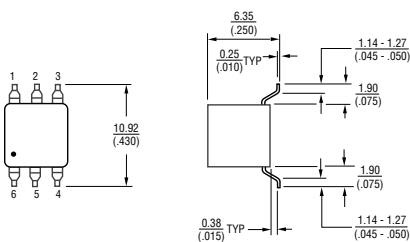

Typical Frequency Response

2-4-1 3 dB Bandwidth 0.200-350 MHz

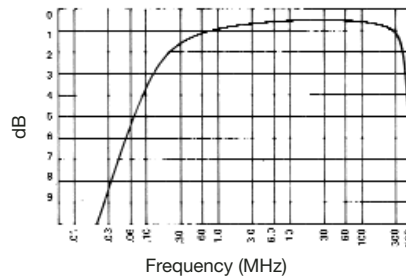

2-3-1 3 dB Bandwidth 0.050-250 MHz

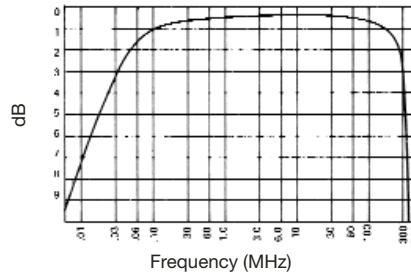

3-1-1 3 dB Bandwidth 0.150-400 MHz

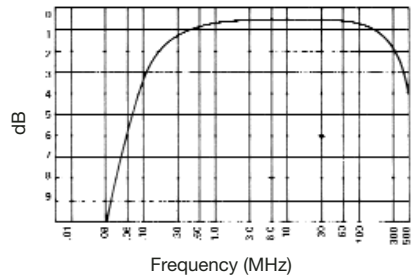

DIMENSIONS ARE: $\frac{\text{MM}}{\text{(INCHES)}}$

How to Order

Model **x - x - x x** **L**

Impedance Ratio
(see "Ratio Impedance")

Type Number

Termination Type
(see "Product Dimensions")
D = Through-hole
W = Surface Mount (Gull-Wing)
J = Surface Mount ("J" Leads)

Impedance Ratio
P = Ratio: Primary to Secondary (R : 1)
Blank = Ratio: Secondary to Primary (R : 1)
Where "R" is the Ratio Impedance in
Electrical Specifications chart

Packaging
E = Tape and Reel (Types J and W only)
Blank = Tubes (Types D and W only)

Termination Material
L = 97Sn/2.5Cu/0.5Ag (lead free)

Packaging

Tape and Reel (Types J and W only)
.....700 pcs./reel
Tubes (Types D and W only)....68 pcs./tube

RF2, RF3, RF4 Series - Wideband Transformers

BOURNS®

Packaging Dimensions

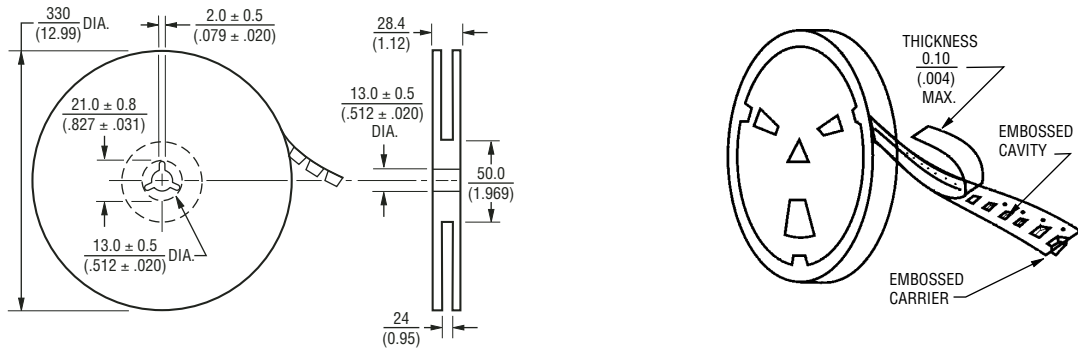

Tape Dimensions for "W" Type

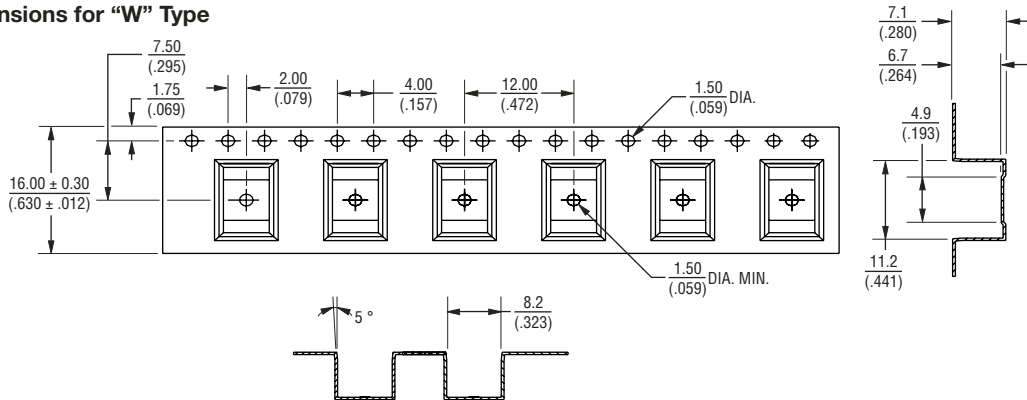

Tape Dimensions for "J" Type

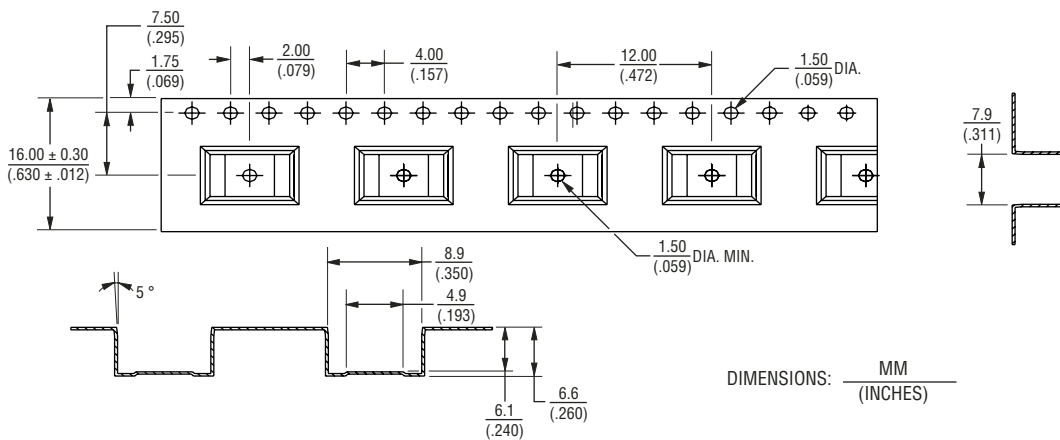

DIMENSIONS: $\frac{\text{MM}}{\text{(INCHES)}}$