

# 2SK3262-01MR

FUJI POWER MOS-FET

## N-CHANNEL SILICON POWER MOS-FET

### ■ Features

- High speed switching
- Low on-resistance
- No secondary breakdown
- Low driving power
- Avalanche-proof

### ■ Applications

- Switching regulators
- UPS (Uninterruptible Power Supply)
- DC-DC converters

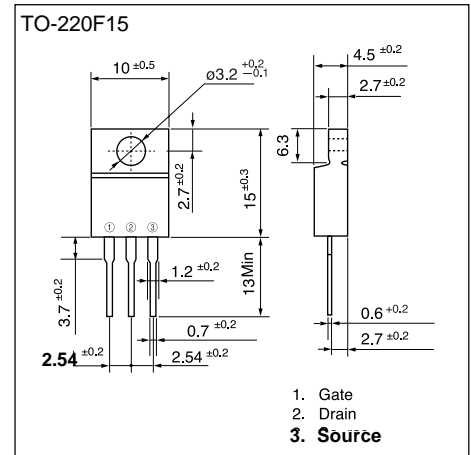

### ■ Maximum ratings and characteristic Absolute maximum ratings

#### ● (Tc=25°C unless otherwise specified)

Item	Symbol	Rating	Unit	
Drain-source voltage	V <sub>DS</sub>	200	V	
Continuous drain current	I <sub>D</sub>	±20	A	
Pulsed drain current	I <sub>D(puls)</sub>	±80	A	
Gate-source voltage	V <sub>GS</sub>	±20	V	
Maximum Avalanche Energy	E <sub>AV*1</sub>	355	mJ	
Max. power dissipation	T <sub>a</sub> =25°C	P <sub>D</sub>	2	W
	T <sub>c</sub> =25°C	P <sub>D</sub>	45	W
Operating and storage temperature range	T <sub>ch</sub>	+150	°C	
	T <sub>stg</sub>	-55 to +150	°C	

\*1 L=1.6mH, V<sub>cc</sub>=24V

### ■ Equivalent circuit schematic

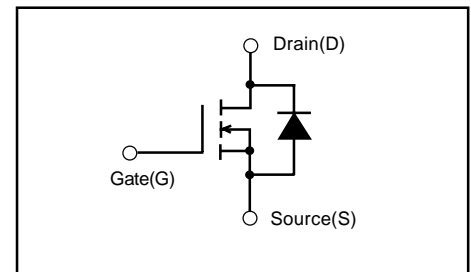

### ● Electrical characteristics (T<sub>c</sub> =25°C unless otherwise specified)

Item	Symbol	Test Conditions	Min.	Typ.	Max.	Units
Drain-source breakdown voltage	V <sub>(BR)DSS</sub>	I <sub>D</sub> =1mA V <sub>GS</sub> =0V	200			V
Gate threshold voltage	V <sub>GS(th)</sub>	I <sub>D</sub> =1mA V <sub>DS</sub> =V <sub>GS</sub>	1.0	1.5	2.0	V
Zero gate voltage drain current	I <sub>DSS</sub>	V <sub>DS</sub> =200V V <sub>GS</sub> =0V	T <sub>ch</sub> =25°C	10	500	μA
			T <sub>ch</sub> =125°C	0.2	0.5	mA
Gate-source leakage current	I <sub>GSS</sub>	V <sub>GS</sub> =±20V V <sub>DS</sub> =0V		10	100	nA
Drain-source on-state resistance	R <sub>DS(on)</sub>	I <sub>D</sub> =10A V <sub>GS</sub> =4V		110	150	mΩ
		I <sub>D</sub> =10A V <sub>GS</sub> =10V		85	100	
Forward transconductance	g <sub>fs</sub>	I <sub>D</sub> =10A V <sub>DS</sub> =25V	9.0	19.0		S
Input capacitance	C <sub>iss</sub>	V <sub>DS</sub> =25V		1700	2550	pF
Output capacitance	C <sub>oss</sub>	V <sub>GS</sub> =0V		290	435	
Reverse transfer capacitance	C <sub>rss</sub>	f=1MHz		185	280	
Turn-on time t <sub>on</sub>	t <sub>d(on)</sub>	V <sub>CC</sub> =100V I <sub>D</sub> =20A V <sub>GS</sub> =10V		10	15	ns
			t <sub>r</sub>		45	
Turn-off time t <sub>off</sub>	t <sub>d(off)</sub>	R <sub>G</sub> =10Ω		225	340	
			t <sub>f</sub>		120	
Avalanche capability	I <sub>AV</sub>	L=100μH T <sub>ch</sub> =25°C	20			A
Diode forward on-voltage	V <sub>SD</sub>	I <sub>F</sub> =20A V <sub>GS</sub> =0V T <sub>ch</sub> =25°C		0.93	1.40	V
Reverse recovery time	t <sub>rr</sub>	I <sub>F</sub> =20A V <sub>GS</sub> =0V		250		ns
Reverse recovery charge	Q <sub>rr</sub>	-di/dt=100A/μs T <sub>ch</sub> =25°C		2.90		μC

### ● Thermal characteristics

Item	Symbol	Test Conditions	Min.	Typ.	Max.	Units
Thermal resistance	R <sub>th(ch-c)</sub>	channel to case			2.78	°C/W
	R <sub>th(ch-a)</sub>	channel to ambient			62.5	°C/W

Characteristics

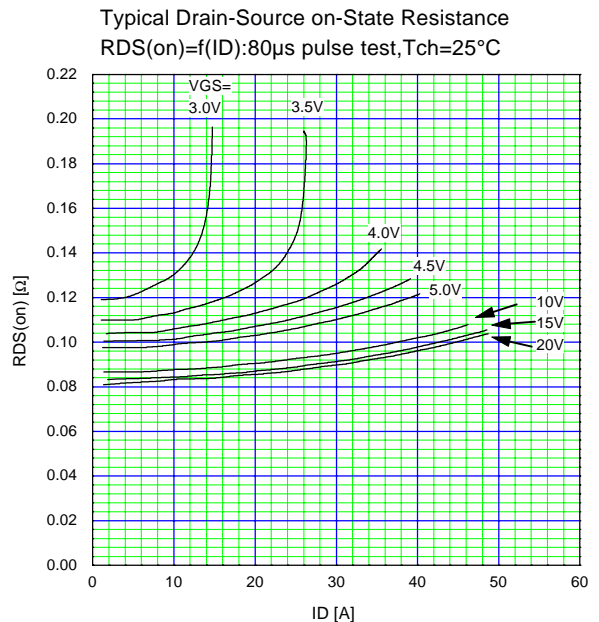
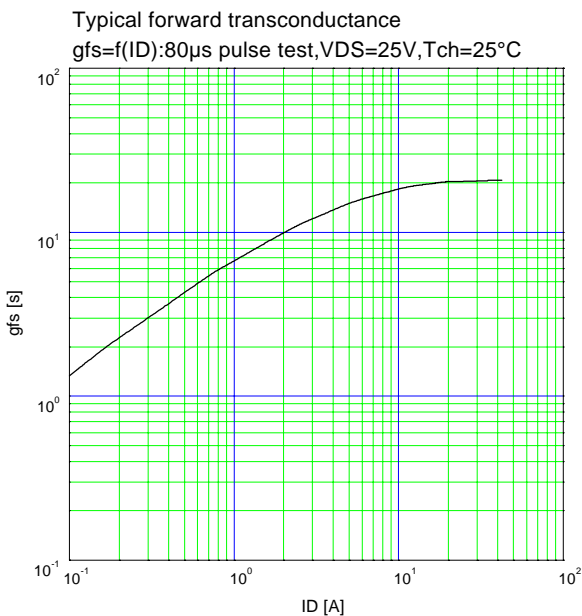
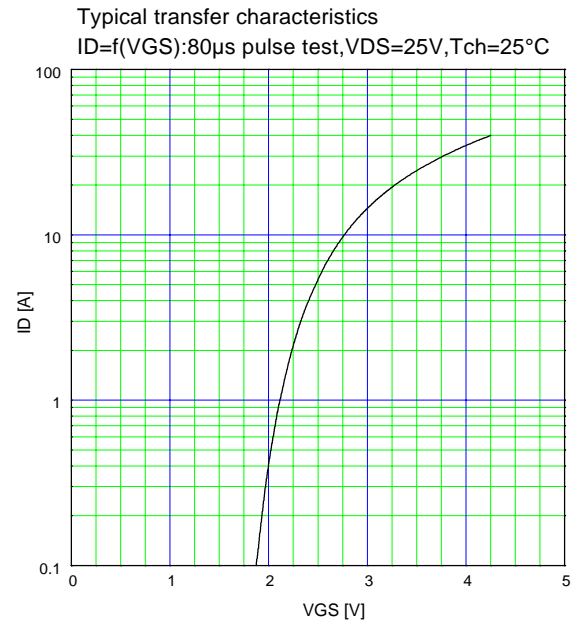
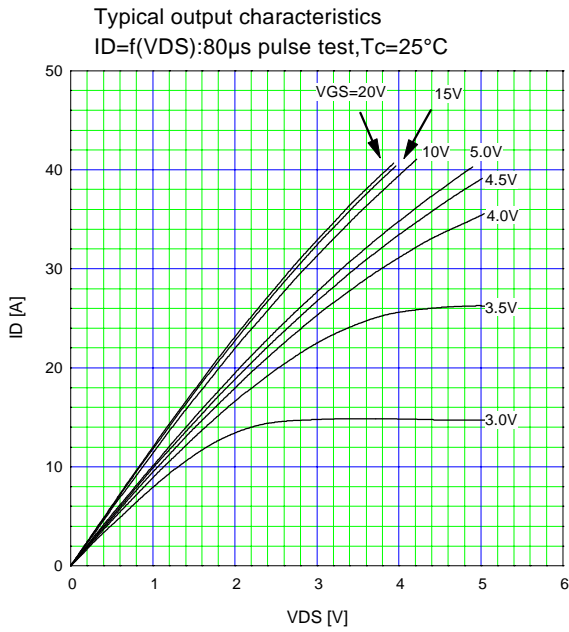
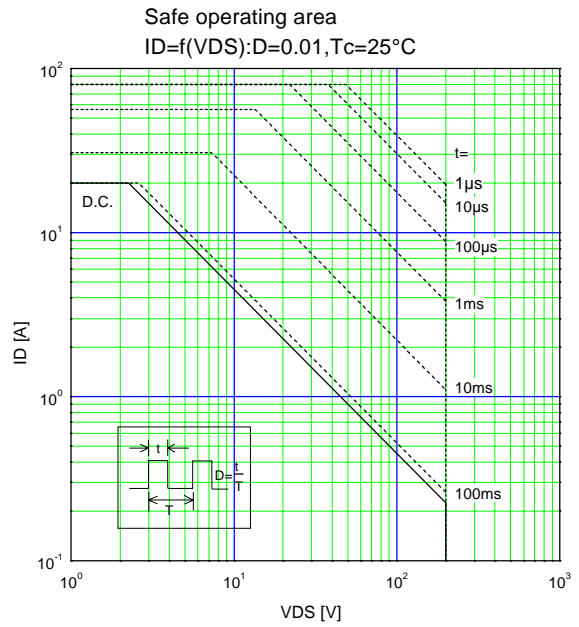
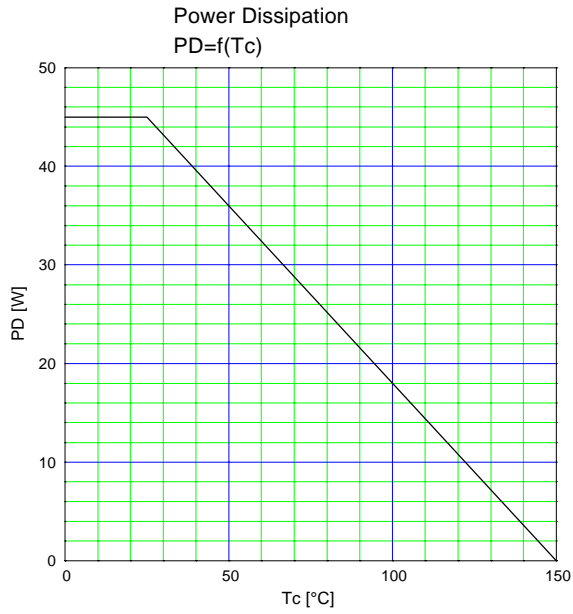

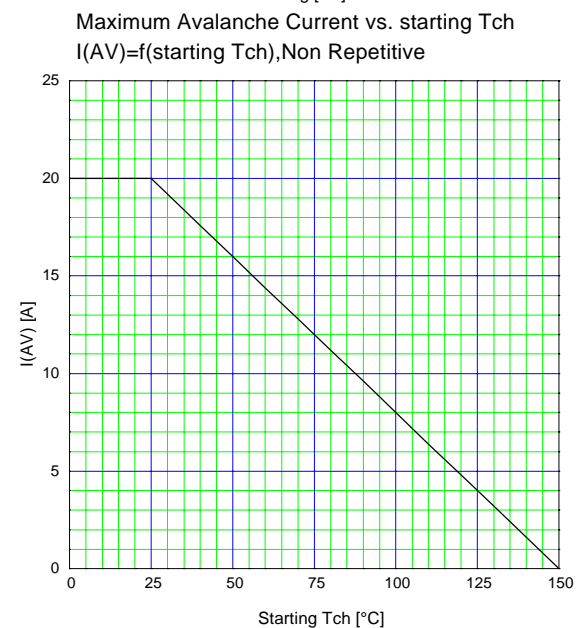
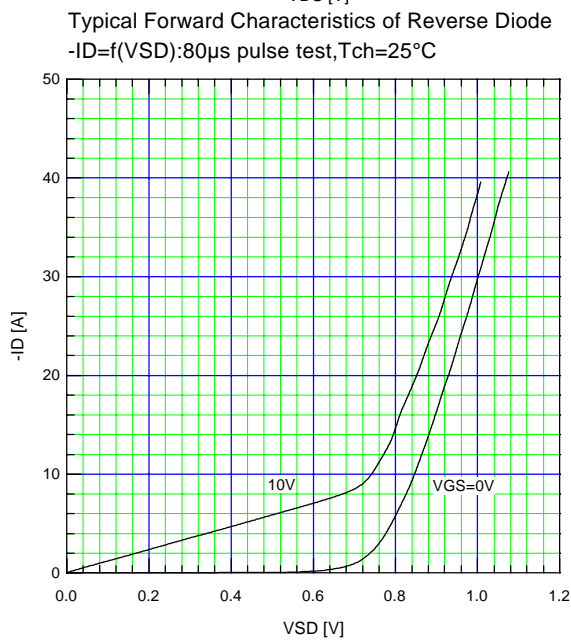
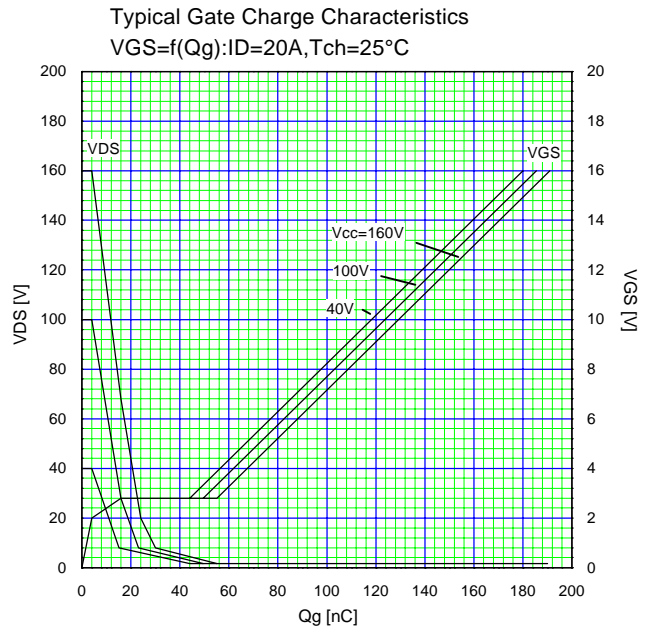
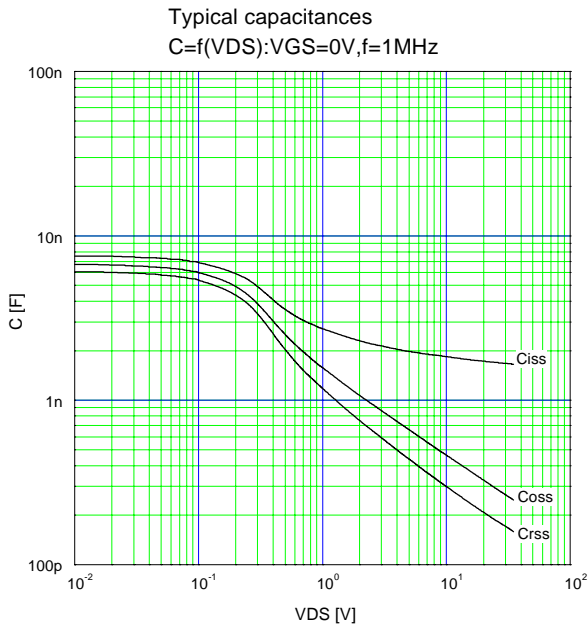
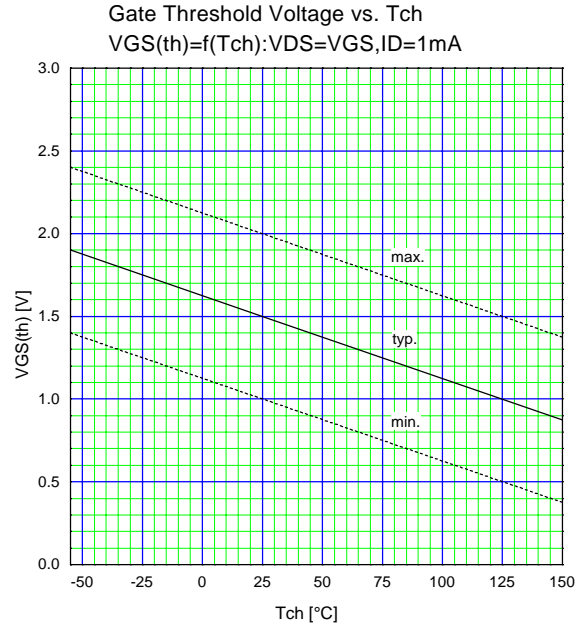
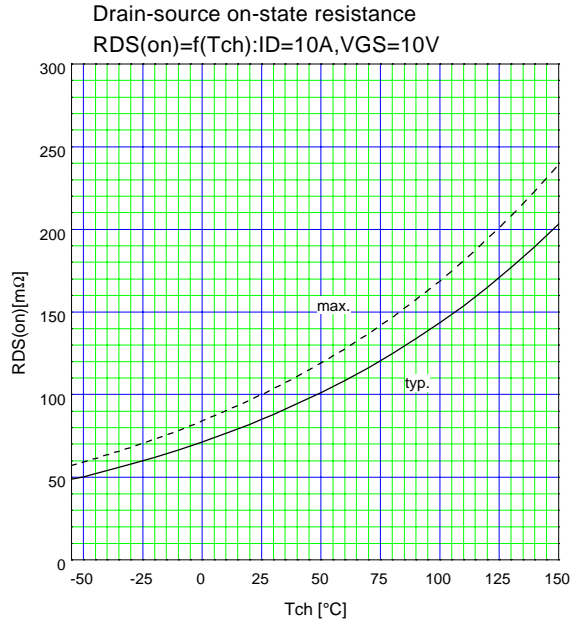

Maximum Avalanche energy vs. starting Tch  
 $E_{as} = f(\text{starting Tch}) : V_{cc} = 24V_{AV}, I_{AV} \leq 20A, \text{Non-Repitative}$

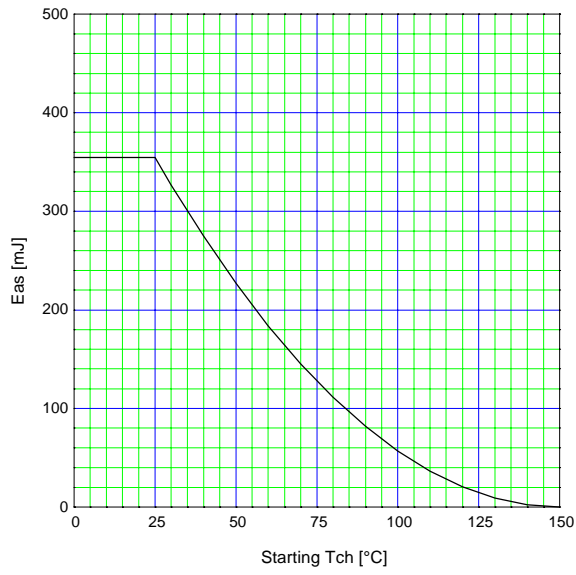

Transient Thermal Impedance  
 $Z_{th}(ch-c) = f(t) : D = t/T$

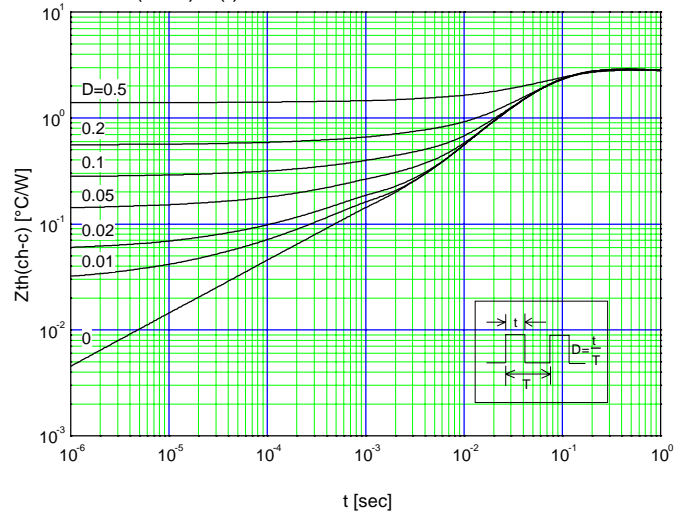

This datasheet has been download from:

[www.datasheetcatalog.com](http://www.datasheetcatalog.com)

Datasheets for electronics components.