

Amphenol

www.amphenol.co.uk

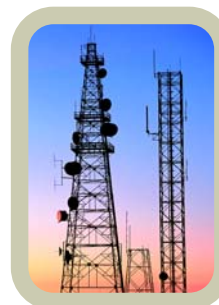

62IP / 162IP

**Industrial Plastic
Connectors**

**ROHS
Compliant**

For more information call **01227 773200**

Amphenol Ltd, Thanet Way, Whitstable, Kent, CT5 3JF, England

62IP / 162IP

Industrial Plastic – IP Series Connectors



The Industrial Plastic (IP) range of miniature bayonet locking connectors, has both 62IP as solder non-removable contacts, and 162IP as crimp removable contacts. These are fully interchangeable with Amphenol Ltd 62 Series connectors and accessories.

The designs are based on BS 9522 F0017. The shells are moulded from Thermoplastic, as are the applicable panel nuts, coupling nuts and accessories. This gives a smooth, low lustre black finish that, once moulded, does not require any plating or further processes.

Insert material is neoprene rubber and the contacts are machined and gold plated, the same as the GB range of connectors for both 62 and 162.

Other key benefits are:

- Salt Spray 500 hours
- Rated to IP67
- 500 mating cycles minimum
- Contact resistance 5 milliohms maximum
- Insulation resistance 5000 Megohms @ 500VDC minimum
- Contact Rating:
 - 7.5A for Size 20 contacts
 - 13A for Size 16 contacts
- Temperature range -40°C to $+110^{\circ}\text{C}$



62IP / 162IP

Available Inserts

62IP Available Inserts

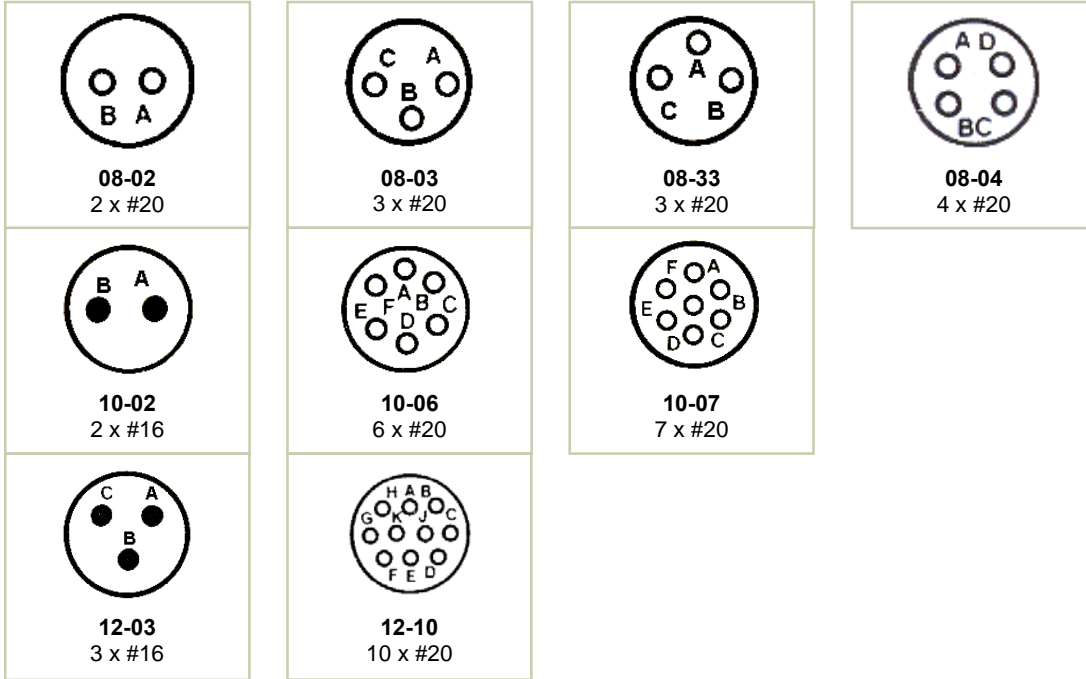

162IP Available Inserts

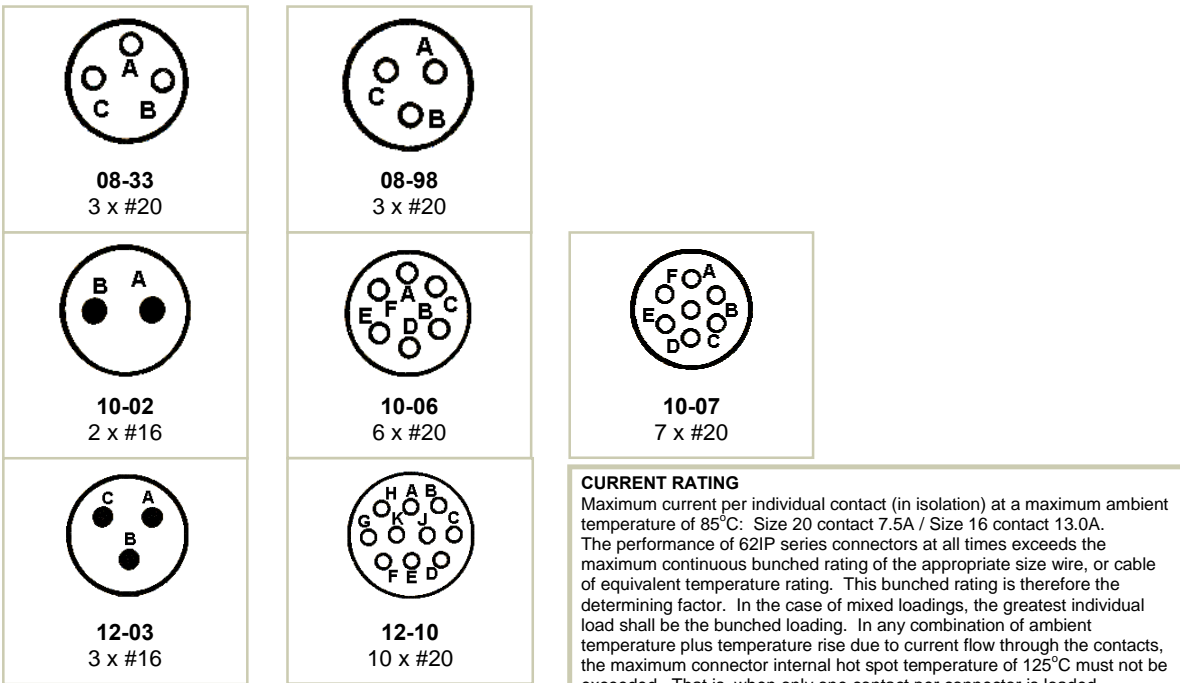

Contact Rating:

- 7.5A for Size 20 Contacts
- 13A for Size 16 Contacts



62IP Receptacles

Solder Non-Removable Contacts

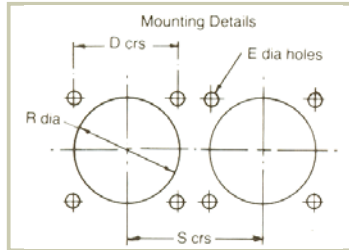

12E

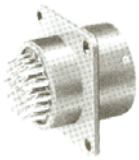

62IP-12E

4-Hole Flange Mounting with plain shell with solder buckets

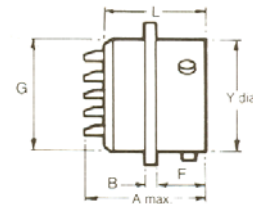
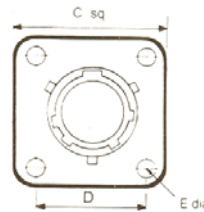

Shell Size	A max	B ± 0.005 (± 0.13)	C max Sq.	D TP Sq.	E dia ± 0.010 (± 0.254)	F ± 0.005 (± 0.13)	G dia max.	L	S	Y dia. max.
08	0.978	0.062	0.817	0.594	0.120	0.445	0.434	0.800	1.250	0.473
	24.84	1.58	20.75	15.09	3.05	11.3	11.02	20.32	31.73	12.02
10	0.978	0.062	0.942	0.719	0.120	0.445	0.558	0.800	1.359	0.590
	24.84	1.58	23.93	18.26	3.05	11.3	14.17	20.32	34.52	14.99
12	0.978	0.062	1.036	0.812	0.120	0.445	0.683	0.800	1.531	0.750
	24.84	1.58	26.32	20.63	3.05	11.3	17.35	20.32	38.89	19.05

12E (219)

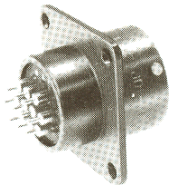

62IP-12E (219)

4-hole flange mounting with plain shell with film wire terminations

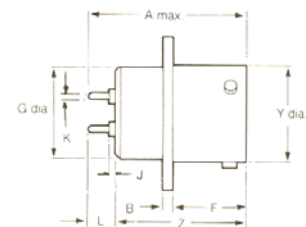
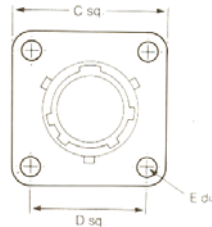

Shell Size	A max	B ± 0.005 (± 0.13)	C max Sq.	D TP Sq.	E dia ± 0.010	F ± 0.005 (± 0.13)	G dia max.	J ± 0.020 (± 0.51)	K min max	L max max	Y dia. max.	Z
08	0.982	0.062	0.817	0.594	0.120	0.445	0.434	0.089	0.030 0.028	0.198 0.166	0.473	0.800
	24.95	1.58	20.75	15.09	3.05	11.3	11.02	2.26	0.76 0.70	5.03 4.22	12.02	20.32
10	0.982	0.062	0.942	0.719	0.120	0.445	0.558	0.089	0.030 0.028	0.198 0.166	0.590	0.800
	24.95	1.58	23.93	18.26	3.05	11.3	14.17	2.26	0.76 0.70	5.03 4.22	14.99	20.32
12	0.982	0.062	1.036	0.812	0.120	0.445	0.683	0.089	0.030 0.028	0.198 0.166	0.750	0.800
	24.95	1.58	26.32	20.63	3.05	11.3	17.35	2.26	0.76 0.70	5.03 4.22	19.05	20.32



62IP Plugs

Solder Bucket, Non-Removable Contacts



62IP-56T

Basic Plug with Threaded Shell to accept Standard Cable Assemblies

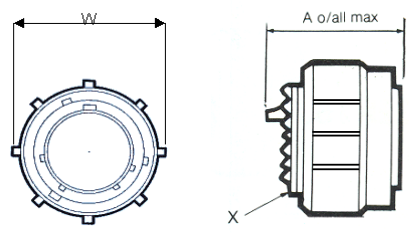

Shell Size	A max	Overall dia. Max. W (044) in mm	X Thread
08	0.976 24.79	0.870 22.1	7/16 – 28 UNEF
10	0.976 24.79	0.979 24.865	9/16 – 24 NEF
12	0.976 24.79	1.151 29.235	11/16 – 24 NEF

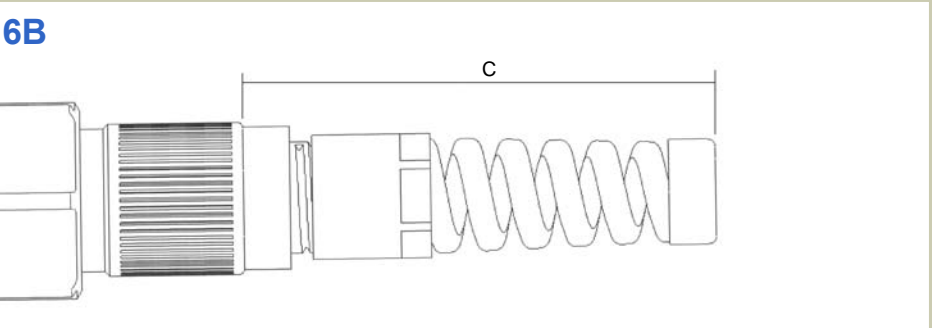
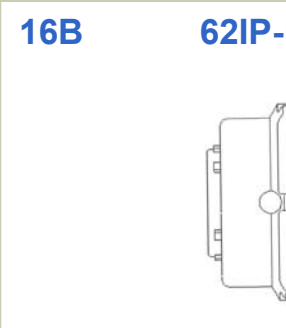

Shell Size	C Length mm	Cable Entry
08	64	3, 5-7 OD mm
10	64	3, 5-7 OD mm
12	64	7-13 OD mm



162IP Receptacles

Crimp Removable Contacts

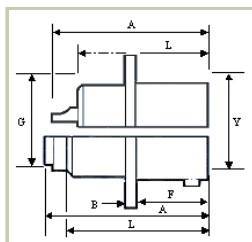

12E

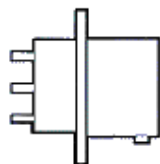

162IP-12E

4-Hole Flange Mounting with plain shell with crimp removable contacts

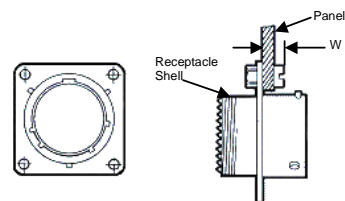

Shell Size	'A' Overall Length Max				'L' Shell Lengths
	30T in mm	(162) 10E in mm	(162) 10F in mm	(162) 12E in mm	(162) 12E in mm
08	1.286	1.320	1.759	1.286	0.917
	32.665	33.53	44.68	32.665	23.29
10	1.286	1.320	1.759	1.286	0.917
	32.665	33.53	44.68	32.665	23.29
12	1.286	1.320	1.759	1.286	0.917
	32.665	33.53	44.68	32.665	23.29

Shell Size	Flange thickness ± 0.005 (± 0.127)	Flange dim. max. sq.	Flange hole centres TP	Flange holes dia. ± 0.005 (± 0.127) -0.002 (-0.051)	Mtg. Flange location ± 0.005 (± 0.127)	Overall Rear dia. max.				Cable sleeve int. dia. ± 0.005 (± 0.127)	Thread	Shell ext. dia. Max.
	B	C	D	E	F	30T	12E	G	10F	H	X	Y
	in mm	in mm	in mm	in mm	in mm	in mm	in mm	in mm	in mm	in mm	in mm	in mm
08	0.062	0.817	0.594	0.120	0.445	0.434	0.434	0.561	0.828	0.156	$7/16$ -28 UNEF	0.473
	1.575	20.75	15.09	3.05	11.3	11.02	11.02	14.25	21.03	3.96		12.015
10	0.062	0.942	0.719	0.120	0.445	0.558	0.558	0.686	0.891	0.188	$9/16$ -24 NEF	0.590
	1.575	23.925	18.27	3.05	11.3	14.17	14.17	17.425	22.63	4.775		14.99
12	0.062	1.036	0.812	0.120	0.445	0.683	0.683	0.811	1.016	0.312	$11/16$ -24 NEF	0.750
	1.575	26.315	20.625	3.05	11.3	17.35	17.35	20.60	25.805	7.925		19.05



162IP Plugs

Crimp Removable Contacts

162IP-36T

Basic Plug with Threaded Shells
To accept standard Cable Assemblies

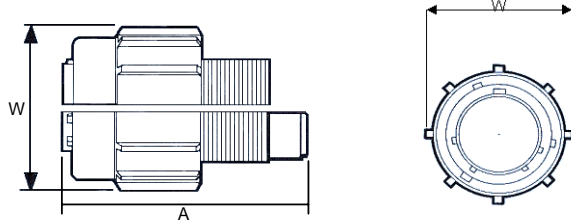

Shell Size	'A' Overall Length max	Overall dia. Max. W (044) in mm
08	1.277	0.870
	32.44	22.1
10	1.277	0.979
	32.44	24.865
12	1.277	1.151
	32.44	29.235

162 OVERALL MATED DIMENSIONS

Add the two relevant plug and receptacle overall Dimensions and deduct:
- 0.303 (7.696mm) for all sizes

62IP / 162IP

Caps

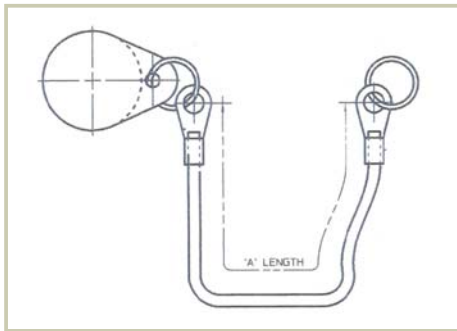

Shell Size	Part Number	A Length after Assembly
08	62-5323-001-XXX	50mm
10	62-5323-002-XXX	100mm
12	62-5323-003-XXX	150mm



162IP / 62IP Assembly Instructions

WIRE STRIPPING – 162IP SERIES

Strip 5.6mm (.220 in) to 6.6mm (.260 in) of insulation from end of wire for both size 20 and 16 contacts taking care not to cut or nick strands. If ends fray twist them back to their original lay.

CONTACT AND WIRE DATA – 162IP SERIES

Contact Size	Colour Code	Contact Part Nos	Suitable Wire Sizes		Permissible Insulation O.D. range for Grommet Sealing	Stripping Lengths in mm
			A.W.G.	in mm		
20	RED	Pin: 162GB-149-20000-05 Skt: 162GB-101-20000-05	20, 22, 24	0.032 – 0.020 0.81-0.51	0.047 – 0.085 1.19 - 2.16	0.220-0.260 5.6 - 6.6
16	BLUE	Pin: 162GB-149-16000-05 Skt: 162GB-101-16000-05	16, 18, 20	0.051 – 0.032 1.295 – 0.81	0.066 – 0.109 1.675 – 2.77	0.220 – 0.260 5.6 – 6.6

CRIMP WIRE CONTACTS

Use Amphenol 294-542 Crimp Tool (M22520/1-01) with 294-1889-01 Turret Head (M22520/1-02). Release and rotate Turret Knob to proper contact size (as per colour code) and lock adjust Selector Knob on handle to correct wire size [see table].

Insert stripped wire into Contact Pocket until it is visible through inspection hole. Fully seat Contact in Crimp Tool Positioner and close handles in one full stroke. (The Ratchet will not release until tool has completed full stroke). Inspect Crimp for wire visibility through Inspection Hole.

CRIMPING JAW SETTING

Contact Size	Wire Size	Crimp Jaw Setting
20	24	No. 2
	22	No.3
	20	No.4
16	20	No. 4
	18	No. 5
	16	No. 6

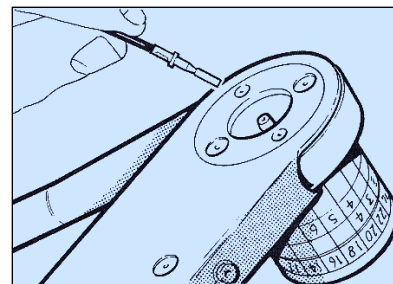
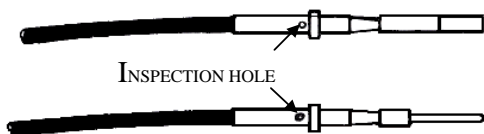

CRIMPING WIRE TO CONTACT

CONTACT INSERTION

Select the proper insertion tool for the size of contact Table 1. The Insertion Tool and procedure are the same for both pin and socket contacts. Slide rear accessory and sleeve over wire bundle. Lay wire in groove of insertion tool and slide contact into front of tool until it is properly located in tool probe. Insert contact into the correct hole in the rear face of the grommet. Keeping contact in line with the axis of the hole, apply a smooth even push on the tool until the contact is fully seated in position. Note: it is essential that the contact and tool are correctly aligned with the axis of hole during insertion to prevent damage to contacts. Withdraw tool at right angles to grommet surface until complete free of connector. All contacts must be inserted whether in circuit or not and the appropriate size sealing plug used behind any contacts that are not wired. Push the sealing plug in by hand until it is fully seated.

Contact Size	Colour Code	Insertion Tool Part No.		Filler Plugs
		Amphenol	M.S.	
20	RED	294GB-5000-20	MS 27488-20	162GB-130-20000
16	BLUE	294-96	MS 24256A-16	162GB-130-16000



162IP

Assembly Instructions

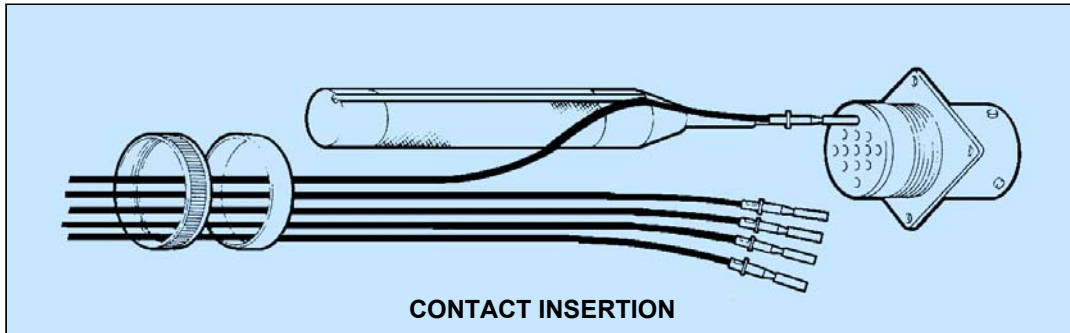

Contact Size

CAUTION: extra care is required in this operation to prevent damage to the connector.

Remove the rear accessory and sleeve and slide back on wire bundle. Select the proper removal tool for the size of contact from table 2. The same tool is used for both pin and socket contacts. Position the removal tool over the contacts to be removed and push until tool probe is fully bottomed, shown when indicator band enters insert hole. Tool is inserted to first band only when removing pin contacts and to the second band for socket contact removal. Slide the plunger knob forward to remove contact.

TABLE 2			
Contact Size	Colour Code	Removal Tool Part Number	
		Amphenol	M.S.
20	RED	294-89	MS 24256R-20
16	BLUE	294-97	MS 25246R-16

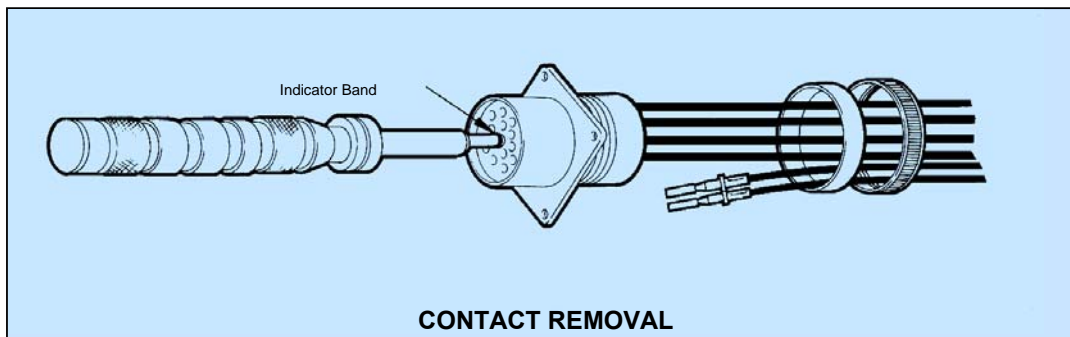

WIRE STRIPPING

For 62IP Connectors with Solder Bucket Contacts

Strip 5.3mm (0.210 in) to 6.1mm (.240 in) of insulation from end of wires to expose centre conductor and tin the ends. If ends fray, twist them back to their original lay before tinning.

Contact Size	Colour Code	Wire Seal and Conductor					
		Wire Insulation				Conductor	
		Min. Dia.		Max. Dia.		Max. Dia.	
Ins	(mm)	Ins	(mm)	Ins	(mm)	Ins	(mm)
20	Red	0.047	(1.19)	0.085	(2.16)	0.042	(1.07)
16	Blue	0.066	(1.68)	0.109	(2.77)	0.062	(1.57)



62IP / 162IP

Available Keyway and Insert Orientations

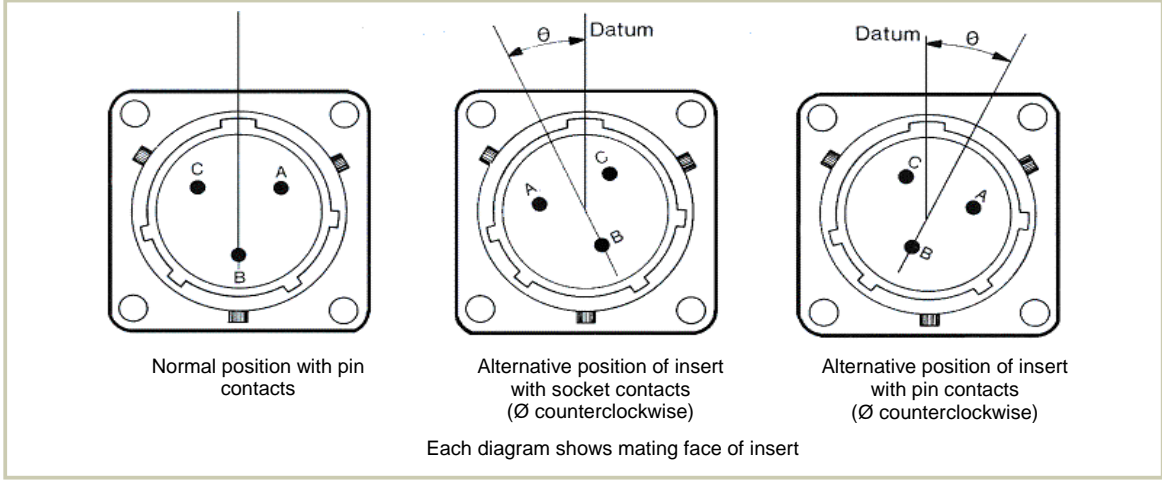

Insert Arrangement	Normal	Orientation 0 (degrees)			Z
		W	X	Y	
8-2	0	58	122	-	-
8-3	0	60	210	-	-
8-33	0	90	-	-	-
8-4	0	45	-	-	-
8-98	0	-	-	-	-
10-2	0	-	-	-	-
10-6	0	90	-	-	-
10-7	0	-	-	-	-
12-3	0	-	-	180	-
12-10	0	60	155	270	295

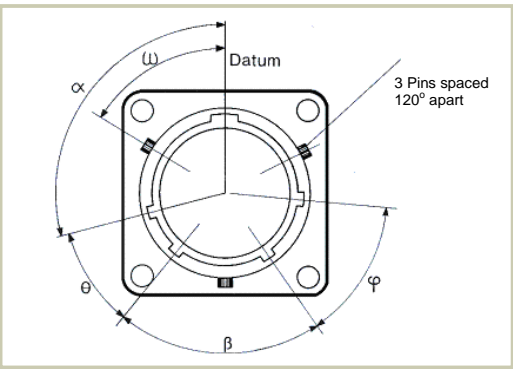

Datum is always taken from major key or keyway. In receptacles the major keyway always remains fixed in relation to the mounting flange.

N.B. The accompanying diagram shows a receptacle shell, with keyways. Corresponding key orientations for a mating plug shell are therefore always clockwise.

Shell Size	Values for α (degrees)	Values for θ (degrees)	Values for β (degrees)	Values for φ (degrees) Orientation	Values for φ (degrees) Orientation
	N	N	N	N	N
08	105	35	75	50	60
10	105	35	75	50	60
12	105	35	75	50	60

62IP

Part Number Information

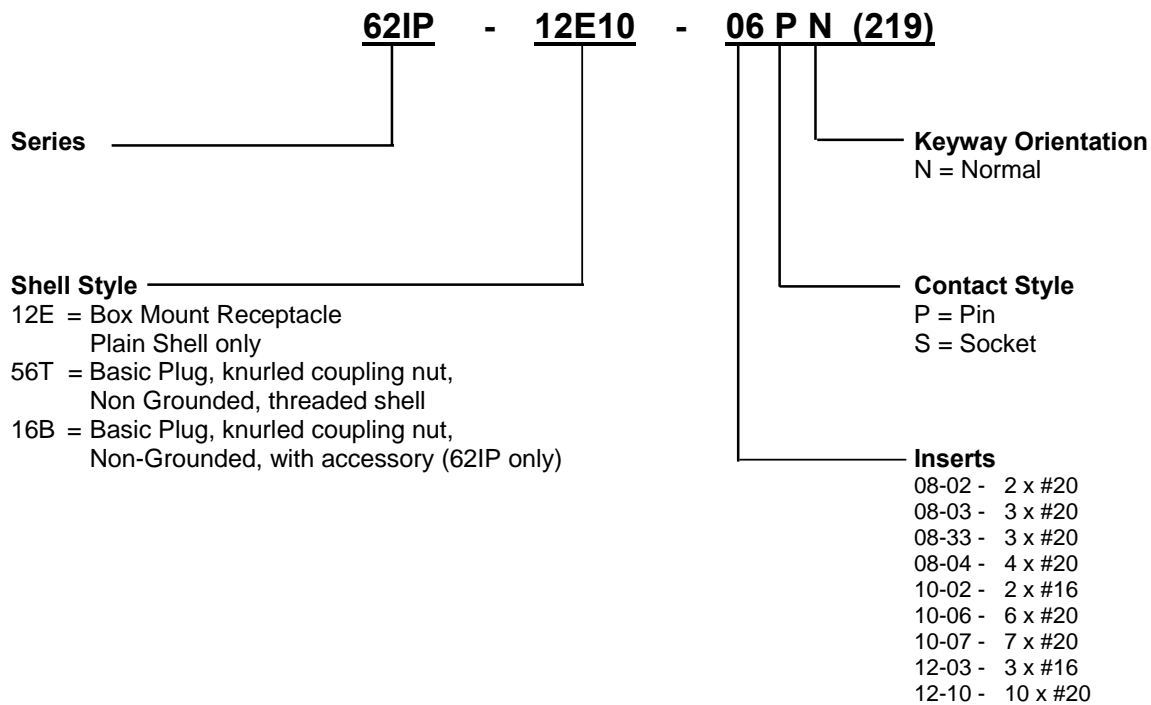

Note:
(219) PCB Contacts – 62IP-12E only.



162IP

Part Number Information

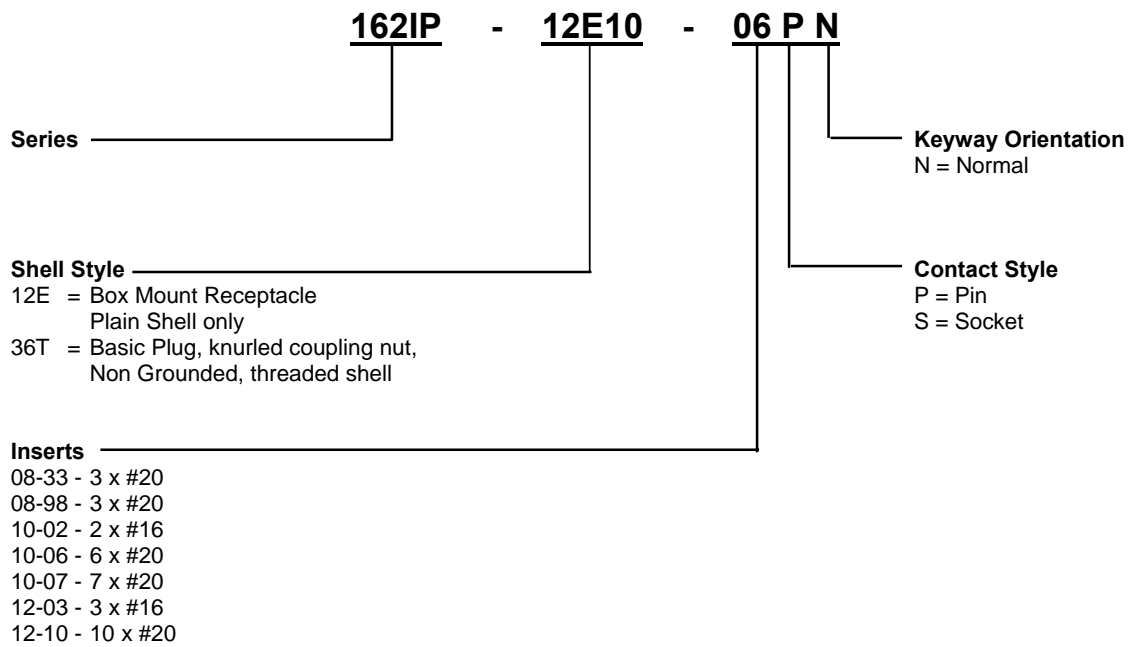

Amphenol

www.amphenol.co.uk

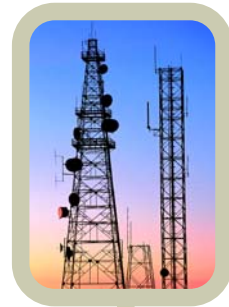

62IP / 162IP

Industrial Plastic Connectors

**ROHS
Compliant**

Notice: Products are sold subject to Amphenol's conditions of sale ("the standard conditions"). All specifications and statements contained herein are believed to be correct at the time of printing but no representation or warranty, express or implied, is given as to any specification or statement contained herein. Product specifications including performance characteristics are typical only and subject to deviation. Specifications are also subject to change without notice. Users should not assume that all safety measures are indicated or that other measures may not be required. No representation or warranty, express or implied, is given that any use of products (including any stated or suggested use) does not infringe any patent, registered design or other third party rights and no stated or suggested use of products can be taken to recommend any such infringement.