

Major Ratings and Characteristics

Characteristics	10BQ015	Units
$I_{F(AV)}$ Rectangular waveform	1.0	A
V_{RRM}	15	V
I_{FSM} @ $t_p = 5 \mu s$ sine	140	A
V_F @ 1.0 Apk, $T_J = 125^\circ C$	0.32	V
T_J range	- 55 to 125	$^\circ C$

Description/ Features

The 10BQ015 surface mount Schottky rectifier has been designed for applications requiring low forward drop and very small foot prints on PC boards. The proprietary barrier technology allows for reliable operation up to 125°C junction temperature. Typical applications are in disk drives, switching power supplies, converters, free-wheeling diodes, battery charging, and reverse battery protection.

- 125°C T_J operation ($V_R < 5V$)
- Optimized for OR-ing applications
- Ultra low forward voltage drop
- High frequency operation
- Guard ring for enhanced ruggedness and long term reliability
- High purity, high temperature epoxy encapsulation for enhanced mechanical strength and moisture resistance

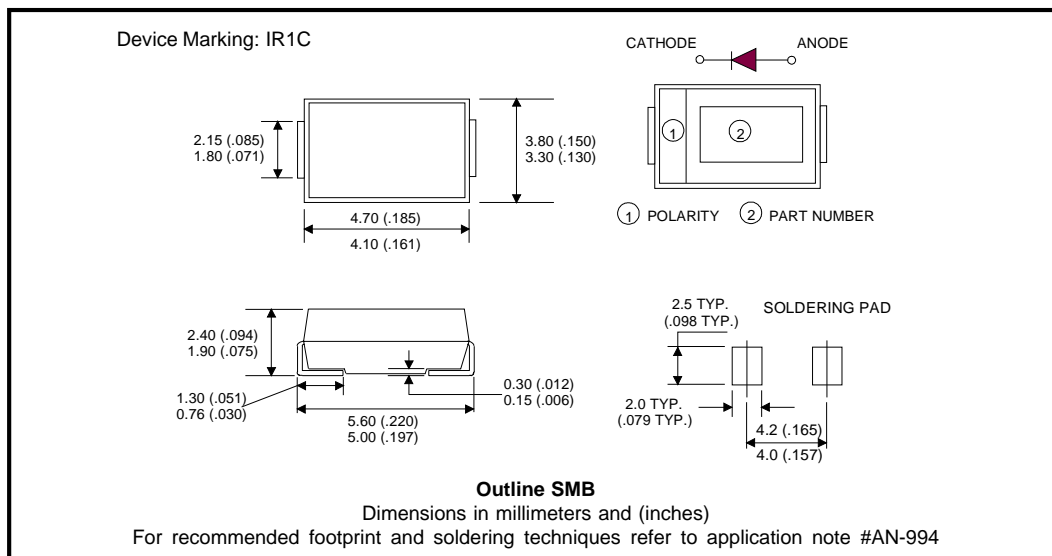

Voltage Ratings

Part number	10BQ015
V_R Max. DC Reverse Voltage (V)	15
V_{RWM} Max. Working Peak Reverse Voltage (V)	25

Absolute Maximum Ratings

Parameters	10BQ	Units	Conditions
$I_{F(AV)}$ Max. Average Forward Current * See Fig. 5	1.0	A	50% duty cycle @ $T_L = 84^\circ\text{C}$, rectangular wave form.
I_{FSM} Max. Peak One Cycle Non-Repetitive Surge Current * See Fig. 7	140	A	5 μs Sine or 3 μs Rect. pulse
	40		10ms Sine or 6ms Rect. pulse
E_{AS} Non-Repetitive Avalanche Energy	1.0	mJ	$T_J = 25^\circ\text{C}$, $I_{AS} = 1\text{A}$, $L = 2\text{mH}$
I_{AR} Repetitive Avalanche Current	1.0	A	Current decayng linearly to zero in 1 μsec Frequency limited by T_J max. $V_A = 1.5 \times V_R$ typical

Electrical Specifications

Parameters	10BQ	Units	Conditions
V_{FM} Max. Forward Voltage Drop (1) * See Fig. 1	0.35	V	@ 1.0A
	0.44	V	@ 2.0A
	0.32	V	@ 1.0A
	0.40	V	@ 2.0A
I_{RM} Max. Reverse Leakage Current (1) * See Fig. 2	0.5	mA	$T_J = 25^\circ\text{C}$
	12	mA	$T_J = 100^\circ\text{C}$
$V_{F(TO)}$ Threshold Voltage	-	V	$T_J = T_J$ max.
r_t Forward Slope Resistance	-	m Ω	
C_T Typical Junction Capacitance	390	pF	$V_R = 5V_{DC}$, (test signal range 100KHz to 1MHz) 25°C
L_S Typical Series Inductance	2.0	nH	Measured lead to lead 5mm from package body
dv/dt Max. Voltage Rate of Change	10000	V/ μs	(Rated V_R)

(1) Pulse Width < 300 μs , Duty Cycle < 2%

Thermal-Mechanical Specifications

Parameters	10BQ	Units	Conditions
T_J Max. Junction Temperature Range (*)	-55 to 125	$^\circ\text{C}$	
T_{stg} Max. Storage Temperature Range	-55 to 150	$^\circ\text{C}$	
R_{thJL} Max. Thermal Resistance Junction to Lead (**)	36	$^\circ\text{C/W}$	DC operation (See Fig. 4)
R_{thJA} Max. Thermal Resistance Junction to Ambient	80	$^\circ\text{C/W}$	DC operation
wt Approximate Weight	0.10 (0.003)	g (oz.)	
Case Style	SMB		Similar to DO-214AA
Device Marking	IR1C		

(*) $\frac{dP_{tot}}{dT_J} < \frac{1}{R_{th(j-a)}}$ thermal runaway condition for a diode on its own heatsink

(**) Mounted 1 inch square PCB

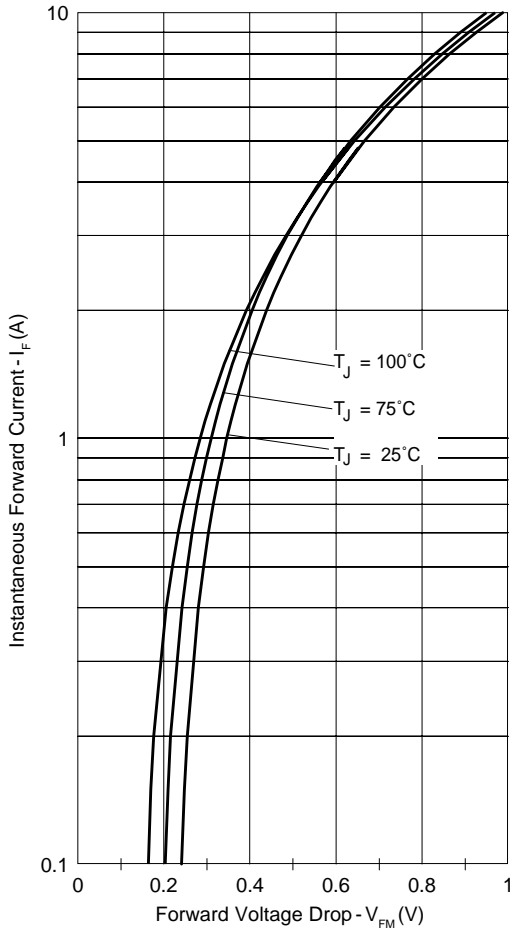

Fig. 1 - Max. Forward Voltage Drop Characteristics

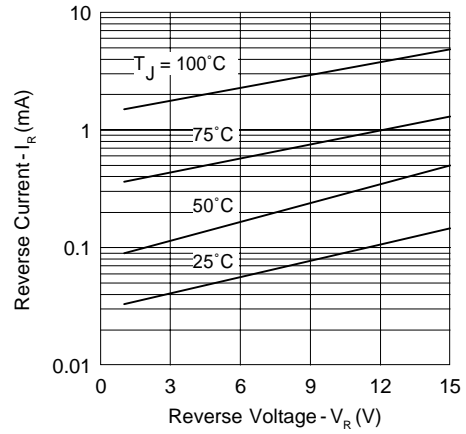

Fig. 2 - Typical Values Of Reverse Current Vs. Reverse Voltage

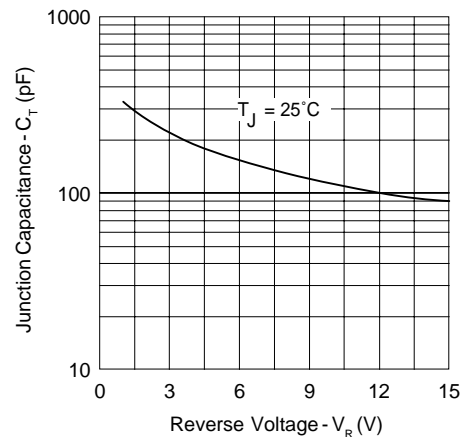

Fig. 3 - Typical Junction Capacitance Vs. Reverse Voltage

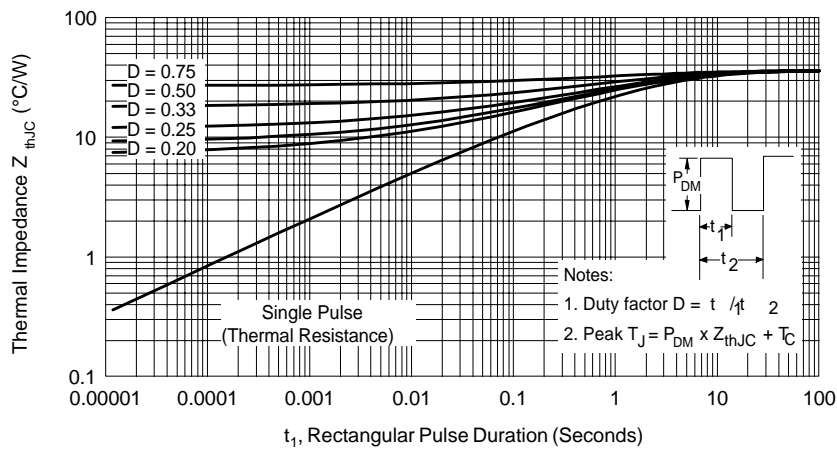

Fig. 4 - Max. Thermal Impedance Z_{thJC} Characteristics (Per Leg)

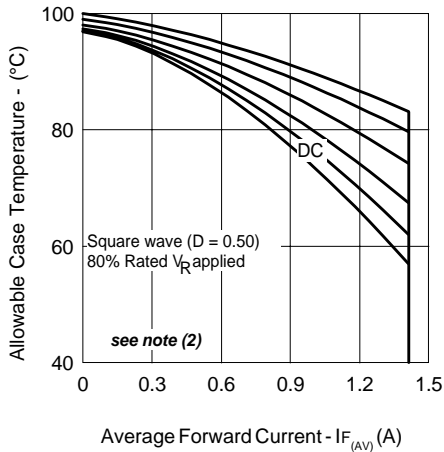

Fig. 5 - Max. Allowable Case Temperature Vs. Average Forward Current

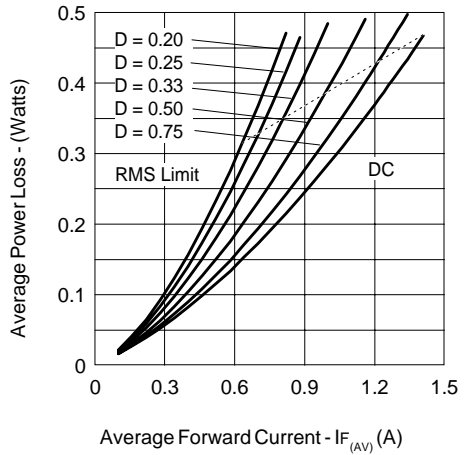

Fig. 6 - Forward Power Loss Characteristics

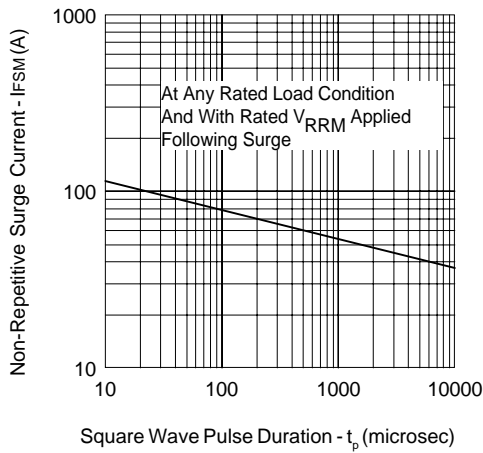
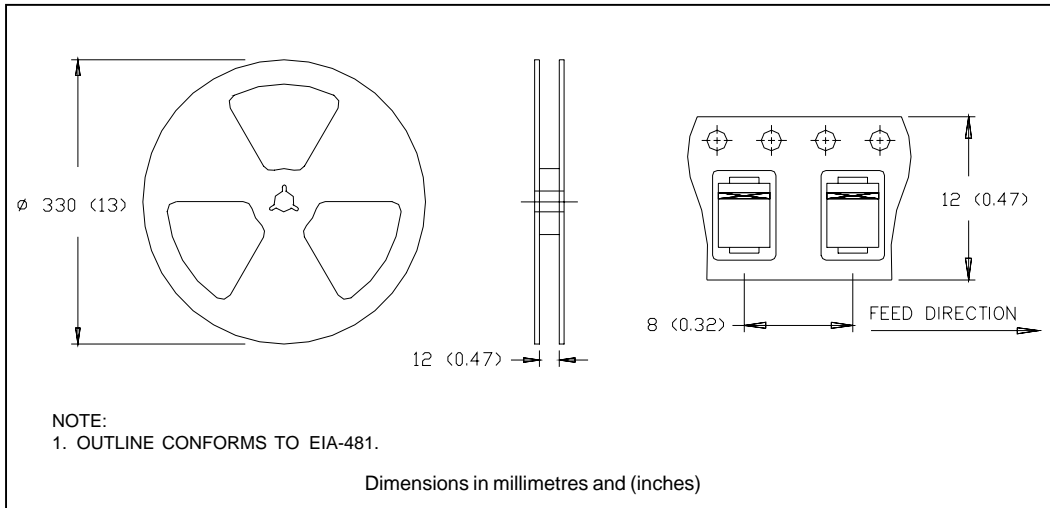

Fig. 7 - Max. Non-Repetitive Surge Current

- (2) Formula used: $T_C = T_J - (Pd + Pd_{REV}) \times R_{thJC}$;
 $Pd = \text{Forward Power Loss} = I_{F(AV)} \times V_{FM} @ (I_{F(AV)} / D)$ (see Fig. 6);
 $Pd_{REV} = \text{Inverse Power Loss} = V_{R1} \times I_R (1 - D)$; $I_R @ V_{R1} = 80\% \text{ rated } V_R$

Tape & Reel Information



Marking & Identification

Each device has 2 rows for identification. The first row designates the device as manufactured by International Rectifier as indicated by the letters "IR", and the Part Number (indicates the current and the voltage rating). The second row indicates the year, the week of manufacturing and the Site ID.

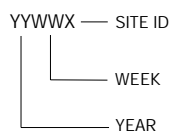
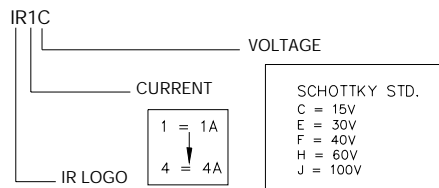

Ordering Information

10BQ SERIES - TAPE AND REEL

WHEN ORDERING, INDICATE THE PART NUMBER AND THE QUANTITY (IN MULTIPLES OF 3000 PIECES).

EXAMPLE: 10BQ015TR - 6000 PIECES

10BQ SERIES - BULK QUANTITIES

WHEN ORDERING, INDICATE THE PART NUMBER AND THE QUANTITY (IN MULTIPLES OF 1000 PIECES).

EXAMPLE: 10BQ015 - 2000 PIECES

10BQ015

Bulletin PD-2.396 rev. H 03/03

International
IOR Rectifier

Data and specifications subject to change without notice.
This product has been designed and qualified for Industrial Level.
Qualification Standards can be found on IR's Web site.

International
IOR Rectifier

IR WORLD HEADQUARTERS: 233 Kansas St., El Segundo, California 90245, USA Tel: (310) 252-7105
TAC Fax: (310) 252-7309
Visit us at www.irf.com for sales contact information. 03/03

This datasheet has been download from:

www.datasheetcatalog.com

Datasheets for electronics components.