

APPROVAL SHEET

MULTILAYER CERAMIC CAPACITORS

General Purpose Series (10V to 100V)

0402 to 1812 Sizes

NP0, X7R & Y5V Dielectrics

RoHS Compliance

*Contents in this sheet are subject to change without prior notice.

1. DESCRIPTION

MLCC consists of a conducting material and electrodes. To manufacture a chip-type SMT and achieve miniaturization, high density and high efficiency, ceramic condensers are used.

WTC's MLCC is made by NP0, X7R and Y5V dielectric material and which provides product with high electrical precision, stability and reliability.

2. FEATURES

- A wide selection of sizes is available (0402 to 1812).
- High capacitance in given case size.
- Capacitor with lead-free termination (pure Tin).

3. APPLICATIONS

- For general digital circuit.
- For power supply bypass capacitors.
- For consumer electronics.
- For telecommunication.

4. HOW TO ORDER

<u>1206</u>	<u>F</u>	<u>104</u>	<u>Z</u>	<u>500</u>	<u>C</u>	<u>T</u>
<u>Size</u>	<u>Dielectric</u>	<u>Capacitance</u>	<u>Tolerance</u>	<u>Rated voltage</u>	<u>Termination</u>	<u>Packaging style</u>
Inch (mm) 0402 (1005)	N =NP0 (COG)	Two significant digits followed by	B =±0.1pF C =±0.25pF	Two significant digits followed by no. of zeros.	C =Cu/Ni/Sn (for NP0, X7R, Y5V dielectric)	T =7" reeled
0603 (1608)	B =X7R	no. of zeros. And R is in place of	D =±0.5pF F =±1%	And R is in place of decimal point.	L =Ag/Ni/Sn (for partial NP0 items)	R =7" reeled (2mm pitch for 0603 size; paper tape)
0805 (2012)	F =Y5V	decimal point.	G =±2% J =±5%			G =13" reeled
1206 (3216)		eg.:	K =±10%	100 =10 VDC		
1210 (3225)		0R5=0.5pF	M =±20%	160 =16 VDC		
1812 (4532)		1R0=1.0pF	Z =-20/+80%	250 =25 VDC		
		104=10x10 ⁴ =100nF		500 =50 VDC		
				101 =100 VDC		

* Partial NP0 items are with Ag/Ni/Sn terminations, please ref to below product range of NPO dielectric for detail.

5. EXTERNAL DIMENSIONS

Size Inch (mm)	L (mm)	W (mm)	T (mm)/Symbol	Remark	M _B (mm)
0402 (1005)	1.00±0.05	0.50±0.05	0.50±0.05	N #	0.25 +0.05/-0.10
0603 (1608)	1.60±0.10	0.80±0.10	0.80±0.07	S	0.40±0.15
	1.60 +0.15/-0.10	0.80 +0.15/-0.10	0.80 +0.15/-0.10	X	
0805 (2012)	2.00±0.15	1.25±0.10	0.60±0.10	A	0.50±0.20
			0.80±0.10	B	
			1.25±0.10	D #	
			1.25±0.20	I #	
1206 (3216)	3.20±0.15	1.60±0.15	0.80±0.10	B	0.60±0.20
			0.95±0.10	C	
			1.15±0.15	J #	
			1.25±0.10	D #	
			3.20±0.20	1.60±0.20	
3.20±0.3/-0.1	1.60±0.3/0.1	1.60±0.30/-0.10	P #		
1210 (3225)	3.20±0.40	2.50±0.30	0.95±0.10	C #	0.75±0.25
			1.25±0.10	D #	
			1.60±0.20	G #	
			2.00±0.20	K #	
			2.50±0.30	M #	
1812 (4532)	4.50±0.40	3.20±0.30	1.25±0.10	D #	0.75±0.25
			2.00±0.20	K #	

Reflow soldering only is recommended.

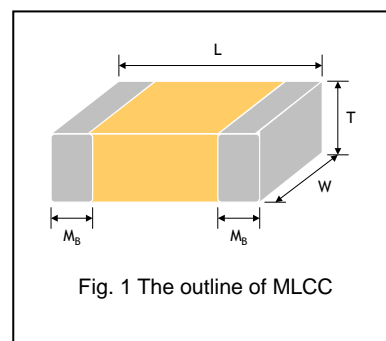

Fig. 1 The outline of MLCC

6. GENERAL ELECTRICAL DATA

Dielectric	NP0	X7R	Y5V
Size	0402, 0603, 0805, 1206, 1210, 1812		
Capacitance range*	0.5pF to 0.039μF	100pF to 0.82μF	10nF to 0.68μF
Capacitance tolerance**	Cap≤5pF: B (±0.1pF), C (±0.25pF) 5pF<Cap<10pF: C (±0.25pF), D (±0.5pF) Cap≥10pF: F (±1%), G (±2%), J (±5%), K (±10%)	J (±5%), K (±10%), M (±20%)	M (±20%), Z (-20/+80%)
Rated voltage (WVDC)	10V, 16V, 25V, 50V, 100V	6.3V, 10V, 16V, 25V, 50V, 100V	
Tan δ*	Cap<30pF: Q≥400+20C Cap≥30pF: Q≥1000	Note 1	
Insulation resistance at Ur	≥10GΩ or RxC≥500Ω-F whichever is less		
Operating temperature	-55 to +125°C		-25 to +85°C
Capacitance characteristic	±30ppm	±15%	+30/-80%
Termination	Ni/Sn (lead-free termination)		

* Measured at the condition of 30~70% related humidity.

NP0: Apply 1.0±0.2Vrms, 1.0MHz±10% for Cap≤1000pF and 1.0±0.2Vrms, 1.0kHz±10% for Cap>1000pF, 25°C at ambient temperature

X7R: Apply 1.0±0.2Vrms, 1.0kHz±10%, at 25°C ambient temperature.

Y5V: Apply 1.0±0.2Vrms, 1.0kHz±10%, at 20°C ambient temperature.

** Preconditioning for Class II MLCC: Perform a heat treatment at 150±10°C for 1 hour, then leave in a mbient condition for 24±2 hours before measurement.

Note 1:

X7R/X5R

Rated vol.	D.F. ≤	Exception of D.F. ≤
≥50V	2.5%	3% 0603≥0.047μF; 0805≥0.18μF; 1206≥0.47μF
25V	3.5%	5% 0805≥1μF; 1210≥10μF
		7% 0603≥0.33μF; 1206≥4.7μF
		10% 0402≥0.10μF; 0603≥0.47μF; 0805≥2.2μF; 1206≥6.8μF
16V	3.5%	5% 0402≥0.033μF; 0603≥0.15μF; 0805≥0.68μF; 1206≥2.2μF; 1210≥4.7μF
		10% 0603≥0.68μF; 0805≥2.2μF; 1206≥4.7μF; 1210≥22μF
10V	5%	10% 0402≥0.33μF; 0603≥0.33μF; 0805≥2.2μF; 1206≥2.2μF; 1210≥22μF;
		15% 0201≥0.1μF; 0402≥1μF
6.3V	10%	15% 0603≥10μF; 0805≥4.7μF; 1206≥47μF; 1210≥100μF;
		20% 0402≥2.2μF

Y5V

Rated vol.	D.F. ≤	Exception of D.F. ≤
≥50V	5%	7% 0603≥0.1μF; 0805≥0.47μF; 1206≥4.7μF
35V	7%	---
25V	5%	7% 0402≥0.047μF; 0603≥0.1μF; 0805≥0.33μF; 1206≥1μF; 1210≥4.7μF
		9% 0402≥0.068μF; 0603≥0.47μF; 1206≥4.7μF; 1210≥22μF
16V (C<1.0μF)	7%	9% 0402≥0.068μF; 0603≥0.68μF 12.5% 0402≥0.22μF
16V (C≥1.0μF)	9%	12.5% 0603≥2.2μF; 0805≥3.3μF; 1206≥10μF; 1210≥22μF; 1812≥47μF
10V	12.5%	20% 0402≥0.47μF
6.3V	20%	---

7. CAPACITANCE RANGE (NP0 Dielectric)

7-1 0402, 0603, 0805 Sizes

DIELECTRIC		NP0														
SIZE		0402					0603					0805				
RATED VOLTAGE		10	16	25	50	100	10	16	25	50	100	10	16	25	50	100
Capacitance	0.1pF (0R1)	N	N	N	N											
	0.2pF (0R2)	N	N	N	N											
	0.3pF (0R3)	N	N	N	N											
	0.4pF (0R4)	N	N	N	N											
	0.5pF (0R5)	N	N	N	N	N	S	S	S	S	S	A	A	A	A	A
	0.6pF (0R6)	N	N	N	N	N	S	S	S	S	S	A	A	A	A	A
	0.7pF (0R7)	N	N	N	N	N	S	S	S	S	S	A	A	A	A	A
	0.8pF (0R8)	N	N	N	N	N	S	S	S	S	S	A	A	A	A	A
	0.9pF (0R9)	N	N	N	N	N	S	S	S	S	S	A	A	A	A	A
	1.0pF (1R0)	N	N	N	N	N	S	S	S	S	S	A	A	A	A	A
	1.2pF (1R2)	N	N	N	N	N	S	S	S	S	S	A	A	A	A	A
	1.5pF (1R5)	N	N	N	N	N	S	S	S	S	S	A	A	A	A	A
	1.8pF (1R8)	N	N	N	N	N	S	S	S	S	S	A	A	A	A	A
	2.2pF (2R2)	N	N	N	N	N	S	S	S	S	S	A	A	A	A	A
	2.7pF (2R7)	N	N	N	N	N	S	S	S	S	S	A	A	A	A	A
	3.3pF (3R3)	N	N	N	N	N	S	S	S	S	S	A	A	A	A	A
	3.9pF (3R9)	N	N	N	N	N	S	S	S	S	S	A	A	A	A	A
	4.7pF (4R7)	N	N	N	N	N	S	S	S	S	S	A	A	A	A	A
	5.6pF (5R6)	N	N	N	N	N	S	S	S	S	S	A	A	A	A	A
	6.8pF (6R8)	N	N	N	N	N	S	S	S	S	S	A	A	A	A	A
	8.2pF (8R2)	N	N	N	N	N	S	S	S	S	S	A	A	A	A	A
	10pF (100)	N	N	N	N	N	S	S	S	S	S	A	A	A	A	A
	12pF (120)	N	N	N	N	N	S	S	S	S	S	A	A	A	A	A
	15pF (150)	N	N	N	N	N	S	S	S	S	S	A	A	A	A	A
	18pF (180)	N	N	N	N	N	S	S	S	S	S	A	A	A	A	A
	22pF (220)	N	N	N	N	N	S	S	S	S	S	A	A	A	A	A
	27pF (270)	N	N	N	N	N	S	S	S	S	S	A	A	A	A	A
	33pF (330)	N	N	N	N	N	S	S	S	S	S	A	A	A	A	A
	39pF (390)	N	N	N	N	N	S	S	S	S	S	A	A	A	A	A
	47pF (470)	N	N	N	N	N	S	S	S	S	S	A	A	A	A	A
	56pF (560)	N	N	N	N	N	S	S	S	S	S	A	A	A	A	A
	68pF (680)	N	N	N	N	N	S	S	S	S	S	A	A	A	A	A
	82pF (820)	N	N	N	N	N	S	S	S	S	S	A	A	A	A	A
	100pF (101)	N	N	N	N	N	S	S	S	S	S	A	A	A	A	A
	120pF (121)	N	N	N	N	N	S	S	S	S	S	A	A	A	A	A
	150pF (151)	N	N	N	N	N	S	S	S	S	S	A	A	A	A	A
	180pF (181)	N	N	N	N	N	S	S	S	S	S	A	A	A	A	A
	220pF (221)	N	N	N	N	N	S	S	S	S	S	A	A	A	A	A
	270pF (271)	N	N	N	N		S	S	S	S	S	A	A	A	A	A
	330pF (331)	N	N	N	N		S	S	S	S	S	A	A	A	A	A
390pF (391)	N	N	N	N		S	S	S	S	S	B	B	B	B	B	
470pF (471)	N	N	N	N		S	S	S	S	S	B	B	B	B	B	
560pF (561)	N	N	N	N		S	S	S	S	S	B	B	B	B	B	
680pF (681)	N	N	N	N		S	S	S	S	S	B	B	B	B	B	
820pF (821)	N	N	N	N		S	S	S	S	S	B	B	B	B	B	
1,000pF (102)	N	N	N	N		S	S	S	S	S	B	B	B	B	B	
1,200pF (122)						X	X	X	X		B	B	B	B	B	
1,500pF (152)						X	X	X	X		B	B	B	B	B	
1,800pF (182)						X	X	X	X		B	B	B	B	B	
2,200pF (222)						X	X	X	X		B	B	B	B	B	
2,700pF (272)						X	X	X	X		D	D	D	D	D	
3,300pF (332)						X	X	X	X		D	D	D	D	D	
3,900pF (392)											D	D	D	D	D	
4,700pF (472)											D	D	D	D	D	
5,600pF (562)											D	D	D	D		
6,800pF (682)											D	D	D	D		
8,200pF (822)											D	D	D	D		
0.010uF (103)											D	D	D	D		
0.012uF (123)											D^	D^				

1. The letter in cell is expressed the symbol of product thickness.
2. The letter in cell with “^” mark is expressed product with Ag/Ni/Sn terminations.
3. For more information about products with special capacitance or other data, please contact WTC local representative.

7-2 1206, 1210, 1812 Sizes

DIELECTRIC		NP0												
SIZE		1206					1210					1812		
RATED VOLTAGE		10	16	25	50	100	10	16	25	50	100	16	50	100
Capacitance	1.0pF (1R0)													
	1.2pF (1R2)	B	B	B	B	B								
	1.5pF (1R5)	B	B	B	B	B								
	1.8pF (1R8)	B	B	B	B	B								
	2.2pF (2R2)	B	B	B	B	B								
	2.7pF (2R7)	B	B	B	B	B								
	3.3pF (3R3)	B	B	B	B	B								
	3.9pF (3R9)	B	B	B	B	B								
	4.7pF (4R7)	B	B	B	B	B								
	5.6pF (5R6)	B	B	B	B	B								
	6.8pF (6R8)	B	B	B	B	B								
	8.2pF (8R2)	B	B	B	B	B								
	10pF (100)	B	B	B	B	B	C	C	C	C	C	D	D	D
	12pF (120)	B	B	B	B	B	C	C	C	C	C	D	D	D
	15pF (150)	B	B	B	B	B	C	C	C	C	C	D	D	D
	18pF (180)	B	B	B	B	B	C	C	C	C	C	D	D	D
	22pF (220)	B	B	B	B	B	C	C	C	C	C	D	D	D
	27pF (270)	B	B	B	B	B	C	C	C	C	C	D	D	D
	33pF (330)	B	B	B	B	B	C	C	C	C	C	D	D	D
	39pF (390)	B	B	B	B	B	C	C	C	C	C	D	D	D
	47pF (470)	B	B	B	B	B	C	C	C	C	C	D	D	D
	56pF (560)	B	B	B	B	B	C	C	C	C	C	D	D	D
	68pF (680)	B	B	B	B	B	C	C	C	C	C	D	D	D
	82pF (820)	B	B	B	B	B	C	C	C	C	C	D	D	D
	100pF (101)	B	B	B	B	B	C	C	C	C	C	D	D	D
	120pF (121)	B	B	B	B	B	C	C	C	C	C	D	D	D
	150pF (151)	B	B	B	B	B	C	C	C	C	C	D	D	D
	180pF (181)	B	B	B	B	B	C	C	C	C	C	D	D	D
	220pF (221)	B	B	B	B	B	C	C	C	C	C	D	D	D
	270pF (271)	B	B	B	B	B	C	C	C	C	C	D	D	D
	330pF (331)	B	B	B	B	B	C	C	C	C	C	D	D	D
	390pF (391)	B	B	B	B	B	C	C	C	C	C	D	D	D
	470pF (471)	B	B	B	B	B	C	C	C	C	C	D	D	D
	560pF (561)	B	B	B	B	B	C	C	C	C	C	D	D	D
	680pF (681)	B	B	B	B	B	C	C	C	C	C	D	D	D
	820pF (821)	B	B	B	B	B	C	C	C	C	C	D	D	D
	1,000pF (102)	B	B	B	B	B	C	C	C	C	C	D	D	D
	1,200pF (122)	B	B	B	B	B	C	C	C	C	C	D	D	D
	1,500pF (152)	B	B	B	B	B	C	C	C	C	C	D	D	D
	1,800pF (182)	B	B	B	B	B	C	C	C	C	C	D	D	D
2,200pF (222)	B	B	B	B	B	C	C	C	C	C	D	D	D	
2,700pF (272)	B	B	B	B	B	C	C	C	C	C	D	D	D	
3,300pF (332)	B	B	B	B	B	C	C	C	C	C	D	D	D	
3,900pF (392)	B	B	B	B	B	C	C	C	C	C	D	D	D	
4,700pF (472)	B	B	B	B	B	C	C	C	C	C	D	D	D	
5,600pF (562)	B	B	B	B	B	C	C	C	C	C	D	D	D	
6,800pF (682)	C	C	C	C	C	C	C	C	C	C	D	D	D	
8,200pF (822)	D	D	D	D	D	C	C	C	C	C	D	D	D	
0.010μF (103)	D	D	D	D	D	C	C	C	C	C	D	D	D	
0.012μF (123)	D^	D^				C	C	D	D	D	D	D	D	
0.015μF (153)	D^	D^				C	C	D	D	D	D	D	D	
0.018μF (183)	D^	D^									D	D	D	
0.022μF (223)	D^	D^									D	D	D	
0.027μF (273)	D^	D^									D	D	D	
0.033μF (333)	D^	D^									D	D	D	
0.039μF (393)	G^	G^												

1. The letter in cell is expressed the symbol of product thickness.
2. The letter in cell with "A" mark is expressed product with Ag/Ni/Sn terminations.
3. For more information about products with special capacitance or other data, please contact WTC local representative.

8. CAPACITANCE RANGE (X7R Dielectric)

8-1 0402, 0603, 0805 Sizes

DIELECTRIC		X7R													
SIZE		0402				0603					0805				
RATED VOLTAGE (VDC)		10	16	25	50	10	16	25	50	100	10	16	25	50	100
Capacitance	100pF (101)	N	N	N	N	S	S	S	S	S	B	B	B	B	B
	120pF (121)	N	N	N	N	S	S	S	S	S	B	B	B	B	B
	150pF (151)	N	N	N	N	S	S	S	S	S	B	B	B	B	B
	180pF (181)	N	N	N	N	S	S	S	S	S	B	B	B	B	B
	220pF (221)	N	N	N	N	S	S	S	S	S	B	B	B	B	B
	270pF (271)	N	N	N	N	S	S	S	S	S	B	B	B	B	B
	330pF (331)	N	N	N	N	S	S	S	S	S	B	B	B	B	B
	390pF (391)	N	N	N	N	S	S	S	S	S	B	B	B	B	B
	470pF (471)	N	N	N	N	S	S	S	S	S	B	B	B	B	B
	560pF (561)	N	N	N	N	S	S	S	S	S	B	B	B	B	B
	680pF (681)	N	N	N	N	S	S	S	S	S	B	B	B	B	B
	820pF (821)	N	N	N	N	S	S	S	S	S	B	B	B	B	B
	1,000pF (102)	N	N	N	N	S	S	S	S	S	B	B	B	B	B
	1,200pF (122)	N	N	N	N	S	S	S	S	S	B	B	B	B	B
	1,500pF (152)	N	N	N	N	S	S	S	S	S	B	B	B	B	B
	1,800pF (182)	N	N	N	N	S	S	S	S	S	B	B	B	B	B
	2,200pF (222)	N	N	N	N	S	S	S	S	S	B	B	B	B	B
	2,700pF (272)	N	N	N	N	S	S	S	S	S	B	B	B	B	B
	3,300pF (332)	N	N	N	N	S	S	S	S	S	B	B	B	B	B
	3,900pF (392)	N	N	N	N	S	S	S	S	S	B	B	B	B	B
	4,700pF (472)	N	N	N	N	S	S	S	S	S	B	B	B	B	B
	5,600pF (562)	N	N	N	N	S	S	S	S	S	B	B	B	B	B
	6,800pF (682)	N	N	N	N	S	S	S	S	S	B	B	B	B	B
	8,200pF (822)	N	N	N	N	S	S	S	S	S	B	B	B	B	B
	0.010μF (103)	N	N	N	N	S	S	S	S	S	B	B	B	B	B
	0.012μF (123)	N	N	N		S	S	S	S		B	B	B	B	B
	0.015μF (153)	N	N	N		S	S	S	S		B	B	B	B	B
	0.018μF (183)	N	N	N		S	S	S	S		B	B	B	B	B
	0.022μF (223)	N	N	N		S	S	S	S		B	B	B	B	B
	0.027μF (273)	N	N	N		S	S	S	S		B	B	B	B	D
	0.033μF (333)	N	N	N		S	S	S	X		B	B	B	B	D
	0.039μF (393)	N	N	N		S	S	S	X		B	B	B	B	D
0.047μF (473)	N	N	N		S	S	S	X		B	B	B	B	D	
0.056μF (563)	N	N			S	S	S	X		B	B	B	B	D	
0.068μF (683)	N	N			S	S	S	X		B	B	B	B	D	
0.082μF (823)	N	N			S	S	S	X		B	B	B	B	D	
0.10μF (104)	N	N			S	S	S	X		B	B	B	B	D	
0.12μF (124)					S	S	X			B	B	B	D		
0.15μF (154)					S	S	X			D	D	D	D		
0.18μF (184)					S	S	X			D	D	D	D		
0.22μF (224)					S	S	X			D	D	D	D		
0.27μF (274)					X	X	X			D	D	D	I		
0.33μF (334)					X	X	X			D	D	D	I		
0.39μF (394)					X	X	X			D	D	D	I		
0.47μF (474)					X	X	X			D	D	D	I		
0.56μF (564)										D	D	D			
0.68μF (684)										D	D	D			
0.82μF (824)										D	D	D			

1. The letter in cell is expressed the symbol of product thickness.
2. For more information about products with special capacitance or other data, please contact WTC local representative.

8-2 1206, 1210, 1812 Sizes

DIELECTRIC		X7R														
SIZE		1206					1210					1812				
RATED VOLTAGE		10	16	25	50	100	10	16	25	50	100	10	16	25	50	100
Capacitance	100pF (101)															
	120pF (121)															
	150pF (151)	B	B	B	B	B										
	180pF (181)	B	B	B	B	B										
	220pF (221)	B	B	B	B	B										
	270pF (271)	B	B	B	B	B										
	330pF (331)	B	B	B	B	B										
	390pF (391)	B	B	B	B	B										
	470pF (471)	B	B	B	B	B										
	560pF (561)	B	B	B	B	B										
	680pF (681)	B	B	B	B	B										
	820pF (821)	B	B	B	B	B										
	1,000pF (102)	B	B	B	B	B	C	C	C	C	C	D	D	D	D	D
	1,200pF (122)	B	B	B	B	B	C	C	C	C	C	D	D	D	D	D
	1,500pF (152)	B	B	B	B	B	C	C	C	C	C	D	D	D	D	D
	1,800pF (182)	B	B	B	B	B	C	C	C	C	C	D	D	D	D	D
	2,200pF (222)	B	B	B	B	B	C	C	C	C	C	D	D	D	D	D
	2,700pF (272)	B	B	B	B	B	C	C	C	C	C	D	D	D	D	D
	3,300pF (332)	B	B	B	B	B	C	C	C	C	C	D	D	D	D	D
	3,900pF (392)	B	B	B	B	B	C	C	C	C	C	D	D	D	D	D
	4,700pF (472)	B	B	B	B	B	C	C	C	C	C	D	D	D	D	D
	5,600pF (562)	B	B	B	B	B	C	C	C	C	C	D	D	D	D	D
	6,800pF (682)	B	B	B	B	B	C	C	C	C	C	D	D	D	D	D
	8,200pF (822)	B	B	B	B	B	C	C	C	C	C	D	D	D	D	D
	0.010μF (103)	B	B	B	B	B	C	C	C	C	C	D	D	D	D	D
	0.012μF (123)	B	B	B	B	B	C	C	C	C	C	D	D	D	D	D
	0.015μF (153)	B	B	B	B	B	C	C	C	C	C	D	D	D	D	D
	0.018μF (183)	B	B	B	B	B	C	C	C	C	C	D	D	D	D	D
	0.022μF (223)	B	B	B	B	B	C	C	C	C	C	D	D	D	D	D
	0.027μF (273)	B	B	B	B	B	C	C	C	C	C	D	D	D	D	D
	0.033μF (333)	B	B	B	B	B	C	C	C	C	C	D	D	D	D	D
	0.039μF (393)	B	B	B	B	B	C	C	C	C	C	D	D	D	D	D
0.047μF (473)	B	B	B	B	B	C	C	C	C	C	D	D	D	D	D	
0.056μF (563)	B	B	B	B	B	C	C	C	C	C	D	D	D	D	D	
0.068μF (683)	B	B	B	B	B	C	C	C	C	C	D	D	D	D	D	
0.082μF (823)	B	B	B	B	D	C	C	C	C	C	D	D	D	D	D	
0.10μF (104)	B	B	B	B	D	C	C	C	C	C	D	D	D	D	D	
0.12μF (124)	B	B	B	B	D	C	C	C	C	C	D	D	D	D	D	
0.15μF (154)	C	C	C	C	G	C	C	C	C	D	D	D	D	D	D	
0.18μF (184)	C	C	C	C	G	C	C	C	C	D	D	D	D	D	D	
0.22μF (224)	C	C	C	C	G	C	C	C	C	D	D	D	D	D	D	
0.27μF (274)	C	C	C	D	G	C	C	C	C	G	D	D	D	D	D	
0.33μF (334)	C	C	C	D	G	C	C	C	D	G	D	D	D	D	D	
0.39μF (394)	C	C	J	P	G	C	C	C	D	M	D	D	D	D	D	
0.47μF (474)	J	J	J	P	G	C	C	C	D	M	D	D	D	D	K	
0.56μF (564)	J	J	J	P	P	D	D	D	D	M	D	D	D	D	K	
0.68μF (684)	J	J	J	P	P	D	D	D	D	K	D	D	D	K	K	
0.82μF (824)	J	J	J	P	P	D	D	D	D	K	D	D	D	K	K	

1. The letter in cell is expressed the symbol of product thickness.
2. For more information about products with special capacitance or other data, please contact WTC local representative.

9. CAPACITANCE RANGE (Y5V Dielectric)

9-1 0402, 0603, 0805 Sizes

DIELECTRIC		Y5V													
SIZE		0402				0603				0805					
RATED VOLTAGE		6.3	10	16	25	50	10	16	25	50	10	16	25	50	100
Capacitance	0.010μF (103)		N	N	N	N	S	S	S	S	A	A	A	A	B
	0.015μF (153)		N	N	N	N	S	S	S	S	A	A	A	A	B
	0.022μF (223)		N	N	N	N	S	S	S	S	A	A	A	A	B
	0.033μF (333)		N	N	N	N	S	S	S	S	A	A	A	A	B
	0.047μF (473)		N	N	N		S	S	S	S	A	A	A	A	B
	0.068μF (683)		N	N	N		S	S	S	S	A	A	A	A	B
	0.10μF (104)		N	N	N		S	S	S	S	A	A	A	A	B
	0.15μF (154)		N	N			S	S	S	S	A	A	A	A	
	0.22μF (224)	N	N	N	N		S	S	S	S	A	A	A	A	
	0.33μF (334)	N	N	N			S	S	S		B	B	B	B	
0.47μF (474)	N	N	N			S	S	X	S	B	B	B	B		
0.68μF (684)	N					S	X			B	B	D	D		

9-2 1206, 1210, 1812 Sizes

DIELECTRIC		Y5V														
SIZE		1206					1210					1812				
RATED VOLTAGE		10	16	25	50	100	10	16	25	50	100	10	16	25	50	100
Capacitance	0.010μF (103)	B	B	B	B	B					C					D
	0.015μF (153)	B	B	B	B	B					C					D
	0.022μF (223)	B	B	B	B	B					C					D
	0.033μF (333)	B	B	B	B	B					C					D
	0.047μF (473)	B	B	B	B	B					C					D
	0.068μF (683)	B	B	B	B	B					C					D
	0.10μF (104)	B	B	B	B	B	C	C	C	C	C	D	D	D	D	D
	0.15μF (154)	B	B	B	B	C	C	C	C	C	C	D	D	D	D	D
	0.22μF (224)	B	B	B	B	C	C	C	C	C	C	D	D	D	D	D
	0.33μF (334)	B	B	B	B		C	C	C	C	C	D	D	D	D	D
0.47μF (474)	B	B	B	B		C	C	C	C		D	D	D	D	D	
0.68μF (684)	B	B	B	B		C	C	C	C		D	D	D	D	D	

- The letter in cell is expressed the symbol of product thickness.
- For more information about products with special capacitance or other data, please contact WTC local representative.

10. PACKAGING STYLE AND QUANTITY

Size	Thickness (mm)/Symbol	Paper tape		Plastic tape	
		7" reel	13" reel	7" reel	13" reel
0402 (1005)	0.50±0.05 N	10k	50k	-	-
0603 (1608)	0.80±0.07 S	4k	15k	-	-
	0.80+0.15/-0.10 X	4k	15k	-	-
0805 (2012)	0.60±0.10 A	4k	15k	-	-
	0.80±0.10 B	4k	15k	-	-
	1.25±0.10 D	-	-	3k	10k
	1.25±0.20 I	-	-	3k	10k
1206 (3216)	0.80±0.10 B	4k	15k	-	-
	0.95±0.10 C	-	-	3k	10k
	1.15±0.15 J	-	-	3k	10k
	1.25±0.10 D	-	-	3k	10k
	1.60±0.20 G	-	-	2k	10k
	1.60+0.30/-0.10 P	-	-	2k	9k
1210 (3225)	0.95±0.10 C	-	-	3k	10k
	1.25±0.10 D	-	-	3k	10k
	1.60±0.20 G	-	-	2k	-
	2.00±0.20 K	-	-	1k	6k
	2.50±0.30 M	-	-	1k	-
1812 (4532)	1.25±0.10 D	-	-	1k	-
	2.00±0.20 K	-	-	1k	-

Unit: pieces

11. RELIABILITY TEST CONDITIONS AND REQUIREMENTS

No.	Item	Test Condition	Requirements																																																																						
1.	Visual and Mechanical	---	No remarkable defect. Dimensions to conform to individual specification sheet.																																																																						
2.	Capacitance	Class I:NP0	Shall not exceed the limits given in the detailed spec.																																																																						
3.	Q/ D.F. (Dissipation Factor)	<p>Cap≤1000pF 1.0±0.2Vrms, 1MHz±10%</p> <p>Cap>1000pF 1.0±0.2Vrms, 1KHz±10%</p> <p>Class II:X7R, X5R, Y5V</p> <p>Cap≤10μF, 1.0±0.2Vrms, 1kHz±10%</p> <p>Cap>10μF, 0.5±0.2Vrms, 120Hz±20%</p>	<p>NP0: Cap≥30pF, Q≥1000; Cap<30pF,Q≥400+20C</p> <p>X7R, X5R:</p> <table border="1"> <thead> <tr> <th>Rated vol.</th> <th>D.F. ≤</th> <th colspan="2">Exception of D.F. ≤</th> </tr> </thead> <tbody> <tr> <td>≥ 50V</td> <td>2.5%</td> <td>3%</td> <td>0603 ≥ 0.047μF; 0805 ≥ 0.18μF; 1206 ≥ 0.47μF</td> </tr> <tr> <td rowspan="3">25V</td> <td rowspan="3">3.5%</td> <td>5%</td> <td>0805 ≥ 1μF; 1210 ≥ 10μF</td> </tr> <tr> <td>7%</td> <td>0603 ≥ 0.33μF; 1206 ≥ 4.7μF</td> </tr> <tr> <td>10%</td> <td>0402 ≥ 0.10μF; 0603 ≥ 0.47μF; 0805 ≥ 2.2μF; 1206 ≥ 6.8μF</td> </tr> <tr> <td rowspan="2">16V</td> <td rowspan="2">3.5%</td> <td>5%</td> <td>0402 ≥ 0.033μF; 0603 ≥ 0.15μF; 0805 ≥ 0.68μF; 1206 ≥ 2.2μF; 1210 ≥ 4.7μF</td> </tr> <tr> <td>10%</td> <td>0603 ≥ 0.68μF; 0805 ≥ 2.2μF; 1206 ≥ 4.7μF; 1210 ≥ 22μF</td> </tr> <tr> <td rowspan="2">10V</td> <td rowspan="2">5%</td> <td>10%</td> <td>0402 ≥ 0.33μF; 0603 ≥ 0.33μF; 0805 ≥ 2.2μF; 1206 ≥ 2.2μF; 1210 ≥ 22μF;</td> </tr> <tr> <td>15%</td> <td>0201 ≥ 0.1μF; 0402 ≥ 1μF</td> </tr> <tr> <td rowspan="2">6.3V</td> <td rowspan="2">10%</td> <td>15%</td> <td>0603 ≥ 10μF; 0805 ≥ 4.7μF; 1206 ≥ 47μF; 1210 ≥ 100μF;</td> </tr> <tr> <td>20%</td> <td>0402 ≥ 2.2μF</td> </tr> </tbody> </table> <p>Y5V:</p> <table border="1"> <thead> <tr> <th>Rated vol.</th> <th>D.F. ≤</th> <th colspan="2">Exception of D.F. ≤</th> </tr> </thead> <tbody> <tr> <td>≥ 50V</td> <td>5%</td> <td>7%</td> <td>0603 ≥ 0.1μF; 0805 ≥ 0.47μF; 1206 ≥ 4.7μF</td> </tr> <tr> <td>35V</td> <td>7%</td> <td>---</td> <td>---</td> </tr> <tr> <td rowspan="2">25V</td> <td rowspan="2">5%</td> <td>7%</td> <td>0402 ≥ 0.047μF; 0603 ≥ 0.1μF; 0805 ≥ 0.33μF; 1206 ≥ 1μF; 1210 ≥ 4.7μF</td> </tr> <tr> <td>9%</td> <td>0402 ≥ 0.068μF; 0603 ≥ 0.47μF; 1206 ≥ 4.7μF; 1210 ≥ 22μF</td> </tr> <tr> <td>16V (C<1.0μF)</td> <td>7%</td> <td>9%</td> <td>0402 ≥ 0.068μF; 0603 ≥ 0.68μF</td> </tr> <tr> <td rowspan="2">16V (C ≥ 1.0μF)</td> <td rowspan="2">9%</td> <td>12.5%</td> <td>0402 ≥ 0.22μF</td> </tr> <tr> <td>12.5%</td> <td>0603 ≥ 2.2μF; 0805 ≥ 3.3μF; 1206 ≥ 10μF; 1210 ≥ 22μF; 1812 ≥ 47μF</td> </tr> <tr> <td>10V</td> <td>12.5%</td> <td>20%</td> <td>0402 ≥ 0.47μF</td> </tr> <tr> <td>6.3V</td> <td>20%</td> <td>---</td> <td>---</td> </tr> </tbody> </table>	Rated vol.	D.F. ≤	Exception of D.F. ≤		≥ 50V	2.5%	3%	0603 ≥ 0.047μF; 0805 ≥ 0.18μF; 1206 ≥ 0.47μF	25V	3.5%	5%	0805 ≥ 1μF; 1210 ≥ 10μF	7%	0603 ≥ 0.33μF; 1206 ≥ 4.7μF	10%	0402 ≥ 0.10μF; 0603 ≥ 0.47μF; 0805 ≥ 2.2μF; 1206 ≥ 6.8μF	16V	3.5%	5%	0402 ≥ 0.033μF; 0603 ≥ 0.15μF; 0805 ≥ 0.68μF; 1206 ≥ 2.2μF; 1210 ≥ 4.7μF	10%	0603 ≥ 0.68μF; 0805 ≥ 2.2μF; 1206 ≥ 4.7μF; 1210 ≥ 22μF	10V	5%	10%	0402 ≥ 0.33μF; 0603 ≥ 0.33μF; 0805 ≥ 2.2μF; 1206 ≥ 2.2μF; 1210 ≥ 22μF;	15%	0201 ≥ 0.1μF; 0402 ≥ 1μF	6.3V	10%	15%	0603 ≥ 10μF; 0805 ≥ 4.7μF; 1206 ≥ 47μF; 1210 ≥ 100μF;	20%	0402 ≥ 2.2μF	Rated vol.	D.F. ≤	Exception of D.F. ≤		≥ 50V	5%	7%	0603 ≥ 0.1μF; 0805 ≥ 0.47μF; 1206 ≥ 4.7μF	35V	7%	---	---	25V	5%	7%	0402 ≥ 0.047μF; 0603 ≥ 0.1μF; 0805 ≥ 0.33μF; 1206 ≥ 1μF; 1210 ≥ 4.7μF	9%	0402 ≥ 0.068μF; 0603 ≥ 0.47μF; 1206 ≥ 4.7μF; 1210 ≥ 22μF	16V (C<1.0μF)	7%	9%	0402 ≥ 0.068μF; 0603 ≥ 0.68μF	16V (C ≥ 1.0μF)	9%	12.5%	0402 ≥ 0.22μF	12.5%	0603 ≥ 2.2μF; 0805 ≥ 3.3μF; 1206 ≥ 10μF; 1210 ≥ 22μF; 1812 ≥ 47μF	10V	12.5%	20%	0402 ≥ 0.47μF	6.3V	20%	---	---
Rated vol.	D.F. ≤	Exception of D.F. ≤																																																																							
≥ 50V	2.5%	3%	0603 ≥ 0.047μF; 0805 ≥ 0.18μF; 1206 ≥ 0.47μF																																																																						
25V	3.5%	5%	0805 ≥ 1μF; 1210 ≥ 10μF																																																																						
		7%	0603 ≥ 0.33μF; 1206 ≥ 4.7μF																																																																						
		10%	0402 ≥ 0.10μF; 0603 ≥ 0.47μF; 0805 ≥ 2.2μF; 1206 ≥ 6.8μF																																																																						
16V	3.5%	5%	0402 ≥ 0.033μF; 0603 ≥ 0.15μF; 0805 ≥ 0.68μF; 1206 ≥ 2.2μF; 1210 ≥ 4.7μF																																																																						
		10%	0603 ≥ 0.68μF; 0805 ≥ 2.2μF; 1206 ≥ 4.7μF; 1210 ≥ 22μF																																																																						
10V	5%	10%	0402 ≥ 0.33μF; 0603 ≥ 0.33μF; 0805 ≥ 2.2μF; 1206 ≥ 2.2μF; 1210 ≥ 22μF;																																																																						
		15%	0201 ≥ 0.1μF; 0402 ≥ 1μF																																																																						
6.3V	10%	15%	0603 ≥ 10μF; 0805 ≥ 4.7μF; 1206 ≥ 47μF; 1210 ≥ 100μF;																																																																						
		20%	0402 ≥ 2.2μF																																																																						
Rated vol.	D.F. ≤	Exception of D.F. ≤																																																																							
≥ 50V	5%	7%	0603 ≥ 0.1μF; 0805 ≥ 0.47μF; 1206 ≥ 4.7μF																																																																						
35V	7%	---	---																																																																						
25V	5%	7%	0402 ≥ 0.047μF; 0603 ≥ 0.1μF; 0805 ≥ 0.33μF; 1206 ≥ 1μF; 1210 ≥ 4.7μF																																																																						
		9%	0402 ≥ 0.068μF; 0603 ≥ 0.47μF; 1206 ≥ 4.7μF; 1210 ≥ 22μF																																																																						
16V (C<1.0μF)	7%	9%	0402 ≥ 0.068μF; 0603 ≥ 0.68μF																																																																						
16V (C ≥ 1.0μF)	9%	12.5%	0402 ≥ 0.22μF																																																																						
		12.5%	0603 ≥ 2.2μF; 0805 ≥ 3.3μF; 1206 ≥ 10μF; 1210 ≥ 22μF; 1812 ≥ 47μF																																																																						
10V	12.5%	20%	0402 ≥ 0.47μF																																																																						
6.3V	20%	---	---																																																																						
4.	Dielectric Strength	<p>To apply voltage (≤100V) 250%.</p> <p>Duration: 1 to 5 sec.</p> <p>Charge and discharge current less than 50mA.</p>	No evidence of damage or flash over during test.																																																																						
5.	Insulation Resistance	To apply rated voltage for max. 120 sec.	<p>10GΩ or RxC ≥ 500Ω-F whichever is smaller.</p> <p>Class II (X7R, X5R, Y5V)</p> <table border="1"> <thead> <tr> <th>Rated voltage</th> <th>Insulation Resistance</th> </tr> </thead> <tbody> <tr> <td>100V: X7R</td> <td rowspan="4">10GΩ or RxC ≥ 100 Ω-F whichever is smaller.</td> </tr> <tr> <td>16V:0402≥0.22μF</td> </tr> <tr> <td>10V:0201≥47nF;0402≥0.47μF;0603≥0.47μF ; 0805≥2.2μF;1206≥4.7μF;1210≥47μF</td> </tr> <tr> <td>6.3V</td> </tr> </tbody> </table>	Rated voltage	Insulation Resistance	100V: X7R	10GΩ or RxC ≥ 100 Ω-F whichever is smaller.	16V:0402≥0.22μF	10V:0201≥47nF;0402≥0.47μF;0603≥0.47μF ; 0805≥2.2μF;1206≥4.7μF;1210≥47μF	6.3V																																																															
Rated voltage	Insulation Resistance																																																																								
100V: X7R	10GΩ or RxC ≥ 100 Ω-F whichever is smaller.																																																																								
16V:0402≥0.22μF																																																																									
10V:0201≥47nF;0402≥0.47μF;0603≥0.47μF ; 0805≥2.2μF;1206≥4.7μF;1210≥47μF																																																																									
6.3V																																																																									
6.	Temperature Coefficient	<p>With no electrical load.</p> <table border="1"> <thead> <tr> <th>T.C.</th> <th>Operating Temp</th> </tr> </thead> <tbody> <tr> <td>NP0</td> <td>-55~125°C at 25°C</td> </tr> <tr> <td>X7R</td> <td>-55~125°C at 25°C</td> </tr> <tr> <td>X5R</td> <td>-55~ 85°C at 25°C</td> </tr> <tr> <td>Y5V</td> <td>-25~ 85°C at 20°C</td> </tr> </tbody> </table>	T.C.	Operating Temp	NP0	-55~125°C at 25°C	X7R	-55~125°C at 25°C	X5R	-55~ 85°C at 25°C	Y5V	-25~ 85°C at 20°C	<table border="1"> <thead> <tr> <th>T.C.</th> <th>Capacitance Change</th> </tr> </thead> <tbody> <tr> <td>NP0</td> <td>Within ±30ppm/°C</td> </tr> <tr> <td>X7R</td> <td>Within ±15%</td> </tr> <tr> <td>X5R</td> <td>Within ±15%</td> </tr> <tr> <td>Y5V</td> <td>Within +30%/-80%</td> </tr> </tbody> </table>	T.C.	Capacitance Change	NP0	Within ±30ppm/°C	X7R	Within ±15%	X5R	Within ±15%	Y5V	Within +30%/-80%																																																		
T.C.	Operating Temp																																																																								
NP0	-55~125°C at 25°C																																																																								
X7R	-55~125°C at 25°C																																																																								
X5R	-55~ 85°C at 25°C																																																																								
Y5V	-25~ 85°C at 20°C																																																																								
T.C.	Capacitance Change																																																																								
NP0	Within ±30ppm/°C																																																																								
X7R	Within ±15%																																																																								
X5R	Within ±15%																																																																								
Y5V	Within +30%/-80%																																																																								
7.	Adhesive Strength of Termination	<p>Pressurizing force : 5N (≤0603) and 10N (>0603)</p> <p>Test time: 10±1 sec.</p>	No remarkable damage or removal of the terminations.																																																																						

No.	Item	Test Condition	Requirements															
8.	Vibration Resistance	<ul style="list-style-type: none"> * Vibration frequency: 10~55 Hz/min. * Total amplitude: 1.5mm * Test time: 6 hrs. (Two hrs each in three mutually perpendicular directions.) 	<ul style="list-style-type: none"> * No remarkable damage. * Cap change and Q/D.F.: To meet initial spec. 															
9.	Solderability	<ul style="list-style-type: none"> * Solder temperature: 235±5°C * Dipping time: 2±0.5 sec. 	95% min. coverage of all metalized area.															
10.	Bending Test	<ul style="list-style-type: none"> * The middle part of substrate shall be pressurized by means of the pressurizing rod at a rate of about 1 mm per second until the deflection becomes 1 mm and then the pressure shall be maintained for 5±1 sec. * Measurement to be made after keeping at room temp. for 24±2 hrs. (Class I) or 48±4 hrs. (Class II). 	<ul style="list-style-type: none"> * No remarkable damage. * Cap change : NP0: within ±5% or 0.5pF whichever is larger X7R, X5R: within ±12.5% Y5V: within ±30% (This capacitance change means the change of capacitance under specified flexure of substrate from the capacitance measured before the test.) 															
11.	Resistance to Soldering Heat	<ul style="list-style-type: none"> * Solder temperature: 260±5°C * Dipping time: 10±1 sec * Preheating: 120 to 150°C for 1 minute before immerse the capacitor in a eutectic solder. * Before initial measurement (Class II only): Perform 150+0/-10°C for 1 hr and then set for 48±4 hrs at room temp. * Measurement to be made after keeping at room temp. for 24±2 hrs. (Class I) or 48±4 hrs. (Class II). 	<ul style="list-style-type: none"> * No remarkable damage. * Cap change: NP0: within ±2.5% or 0.25pF whichever is larger X7R, X5R: within ±7.5% Y5V: within ±20% * Q/D.F., I.R. and dielectric strength: To meet initial requirements. * 25% max. leaching on each edge. 															
12.	Temperature Cycle	<ul style="list-style-type: none"> * Conduct the five cycles according to the temperatures and time. <table border="1" style="margin-left: 20px;"> <thead> <tr> <th>Step</th> <th>Temp. (°C)</th> <th>Time (min.)</th> </tr> </thead> <tbody> <tr> <td>1</td> <td>Min. operating temp. +0/-3</td> <td>30±3</td> </tr> <tr> <td>2</td> <td>Room temp.</td> <td>2~3</td> </tr> <tr> <td>3</td> <td>Max. operating temp. +3/-0</td> <td>30±3</td> </tr> <tr> <td>4</td> <td>Room temp.</td> <td>2~3</td> </tr> </tbody> </table> <ul style="list-style-type: none"> * Before initial measurement (Class II only): Perform 150+0/-10°C for 1 hr and then set for 48±4 hrs at room temp. * Measurement to be made after keeping at room temp. for 24±2 hrs. (Class I) or 48±4 hrs. (Class II). 	Step	Temp. (°C)	Time (min.)	1	Min. operating temp. +0/-3	30±3	2	Room temp.	2~3	3	Max. operating temp. +3/-0	30±3	4	Room temp.	2~3	<ul style="list-style-type: none"> * No remarkable damage. * Cap change : NP0: within ±2.5% or 0.25pF whichever is larger X7R, X5R: within ±7.5% Y5V: within ±20% * Q/D.F., I.R. and dielectric strength: To meet initial requirements.
Step	Temp. (°C)	Time (min.)																
1	Min. operating temp. +0/-3	30±3																
2	Room temp.	2~3																
3	Max. operating temp. +3/-0	30±3																
4	Room temp.	2~3																

No.	Item	Test Condition	Requirements																																																																									
13.	Humidity (Damp Heat) Steady State	<ul style="list-style-type: none"> * Test temp.: 40±2°C * Humidity: 90~95% RH * Test time: 500+24/-0hrs. * Measurement to be made after keeping at room temp. for 24±2 hrs. (Class I) or 48±4 hrs. (Class II). 	<ul style="list-style-type: none"> * No remarkable damage. * Cap change: NP0: within ±5% or 0.5pF whichever is larger X7R, X5R: ≥10V, within ±12.5%; 6.3V, within ±25% Y5V: ≥10V, within ±30%; 6.3V, within +30/-40% * Q/D.F. value: NP0: More than 30pF Q≥350, 10pFsC≤30pF, Q≥275+2.5C Less than 10pF Q≥200+10C <p>X7R, X5R:</p> <table border="1"> <thead> <tr> <th>Rated vol.</th> <th>D.F. ≤</th> <th colspan="2">Exception of D.F. ≤</th> </tr> </thead> <tbody> <tr> <td rowspan="2">≥ 50V</td> <td rowspan="2">3%</td> <td>6%</td> <td>0603 ≥ 0.047μF; 0805 ≥ 0.18μF; 1206 ≥ 0.47μF</td> </tr> <tr> <td>10%</td> <td>0805 ≥ 1μF; 1210 ≥ 10μF</td> </tr> <tr> <td rowspan="3">25V</td> <td rowspan="3">5%</td> <td>14%</td> <td>0603 ≥ 0.33μF; 1206 ≥ 4.7μF</td> </tr> <tr> <td rowspan="2">15%</td> <td>0402 ≥ 0.10μF; 0603 ≥ 0.47μF; 0805 ≥ 2.2μF; 1206 ≥ 6.8μF</td> </tr> <tr> <td>10%</td> <td>0603 ≥ 0.15μF; 0805 ≥ 0.68μF; 1206 ≥ 2.2μF; 1210 ≥ 4.7μF</td> </tr> <tr> <td rowspan="2">16V</td> <td rowspan="2">5%</td> <td>15%</td> <td>0402 ≥ 0.033μF; 0603 ≥ 0.68μF; 0805 ≥ 2.2μF; 1206 ≥ 4.7μF; 1210 ≥ 22μF</td> </tr> <tr> <td>10%</td> <td>0402 ≥ 0.33μF; 0603 ≥ 0.33μF; 0805 ≥ 2.2μF; 1206 ≥ 2.2μF; 1210 ≥ 22μF</td> </tr> <tr> <td rowspan="2">10V</td> <td rowspan="2">7.5%</td> <td>15%</td> <td>0402 ≥ 0.33μF; 0603 ≥ 0.33μF; 0805 ≥ 2.2μF; 1206 ≥ 2.2μF; 1210 ≥ 22μF</td> </tr> <tr> <td>20%</td> <td>0201 ≥ 0.1μF ;0402 ≥ 1μF</td> </tr> <tr> <td rowspan="2">6.3V</td> <td rowspan="2">15%</td> <td>30%</td> <td>0402 ≥ 2.2μF ;0603 ≥ 10μF; 0805 ≥ 4.7μF; 1206 ≥ 47μF; 1210 ≥ 100μF</td> </tr> </tbody> </table> <p>Y5V:</p> <table border="1"> <thead> <tr> <th>Rated vol.</th> <th>D.F. ≤</th> <th colspan="2">Exception of D.F. ≤</th> </tr> </thead> <tbody> <tr> <td rowspan="2">≥ 50V</td> <td rowspan="2">7.5%</td> <td>10%</td> <td>0603 ≥ 0.1μF; 0805 ≥ 0.47μF; 1206 ≥ 4.7μF</td> </tr> <tr> <td>10%</td> <td>---</td> </tr> <tr> <td rowspan="3">25V</td> <td rowspan="3">7.5%</td> <td>10%</td> <td>0402 ≥ 0.047μF; 0603 ≥ 0.1μF; 0805 ≥ 0.33μF; 1206 ≥ 1μF; 1210 ≥ 4.7μF</td> </tr> <tr> <td rowspan="2">15%</td> <td>0402 ≥ 0.068μF; 0603 ≥ 0.47μF; 1206 ≥ 4.7μF; 1210 ≥ 22μF</td> </tr> <tr> <td>12.5%</td> <td>0402 ≥ 0.068μF; 0603 ≥ 0.68μF</td> </tr> <tr> <td rowspan="2">16V (C < 1.0μF)</td> <td rowspan="2">10%</td> <td>20%</td> <td>0402 ≥ 0.22μF</td> </tr> <tr> <td>12.5%</td> <td>0603 ≥ 2.2μF; 0805 ≥ 3.3μF; 1206 ≥ 10μF; 1210 ≥ 22μF; 1812 ≥ 47μF;</td> </tr> <tr> <td>10V</td> <td>20%</td> <td>30%</td> <td>0402 ≥ 0.47μF</td> </tr> <tr> <td>6.3V</td> <td>30%</td> <td>---</td> <td>---</td> </tr> </tbody> </table> <p>*I.R.: ≥10V, 1GΩ or 50 Ω-F whichever is smaller.</p> <p>Class II (X7R, X5R, Y5V)</p> <table border="1"> <thead> <tr> <th>Rated voltage</th> <th>Insulation Resistance</th> </tr> </thead> <tbody> <tr> <td>100V: X7R</td> <td rowspan="4">1GΩ or RxC ≥ 10 Ω-F whichever is smaller.</td> </tr> <tr> <td>16V: 0402 ≥ 0.22μF</td> </tr> <tr> <td>10V: 0201 ≥ 47nF; 0402 ≥ 0.47μF; 0603 ≥ 0.47μF; 0805 ≥ 2.2μF; 1206 ≥ 4.7μF; 1210 ≥ 47μF</td> </tr> <tr> <td>6.3V</td> </tr> </tbody> </table>	Rated vol.	D.F. ≤	Exception of D.F. ≤		≥ 50V	3%	6%	0603 ≥ 0.047μF; 0805 ≥ 0.18μF; 1206 ≥ 0.47μF	10%	0805 ≥ 1μF; 1210 ≥ 10μF	25V	5%	14%	0603 ≥ 0.33μF; 1206 ≥ 4.7μF	15%	0402 ≥ 0.10μF; 0603 ≥ 0.47μF; 0805 ≥ 2.2μF; 1206 ≥ 6.8μF	10%	0603 ≥ 0.15μF; 0805 ≥ 0.68μF; 1206 ≥ 2.2μF; 1210 ≥ 4.7μF	16V	5%	15%	0402 ≥ 0.033μF; 0603 ≥ 0.68μF; 0805 ≥ 2.2μF; 1206 ≥ 4.7μF; 1210 ≥ 22μF	10%	0402 ≥ 0.33μF; 0603 ≥ 0.33μF; 0805 ≥ 2.2μF; 1206 ≥ 2.2μF; 1210 ≥ 22μF	10V	7.5%	15%	0402 ≥ 0.33μF; 0603 ≥ 0.33μF; 0805 ≥ 2.2μF; 1206 ≥ 2.2μF; 1210 ≥ 22μF	20%	0201 ≥ 0.1μF ;0402 ≥ 1μF	6.3V	15%	30%	0402 ≥ 2.2μF ;0603 ≥ 10μF; 0805 ≥ 4.7μF; 1206 ≥ 47μF; 1210 ≥ 100μF	Rated vol.	D.F. ≤	Exception of D.F. ≤		≥ 50V	7.5%	10%	0603 ≥ 0.1μF; 0805 ≥ 0.47μF; 1206 ≥ 4.7μF	10%	---	25V	7.5%	10%	0402 ≥ 0.047μF; 0603 ≥ 0.1μF; 0805 ≥ 0.33μF; 1206 ≥ 1μF; 1210 ≥ 4.7μF	15%	0402 ≥ 0.068μF; 0603 ≥ 0.47μF; 1206 ≥ 4.7μF; 1210 ≥ 22μF	12.5%	0402 ≥ 0.068μF; 0603 ≥ 0.68μF	16V (C < 1.0μF)	10%	20%	0402 ≥ 0.22μF	12.5%	0603 ≥ 2.2μF; 0805 ≥ 3.3μF; 1206 ≥ 10μF; 1210 ≥ 22μF; 1812 ≥ 47μF;	10V	20%	30%	0402 ≥ 0.47μF	6.3V	30%	---	---	Rated voltage	Insulation Resistance	100V: X7R	1GΩ or RxC ≥ 10 Ω-F whichever is smaller.	16V: 0402 ≥ 0.22μF	10V: 0201 ≥ 47nF; 0402 ≥ 0.47μF; 0603 ≥ 0.47μF; 0805 ≥ 2.2μF; 1206 ≥ 4.7μF; 1210 ≥ 47μF	6.3V
Rated vol.	D.F. ≤	Exception of D.F. ≤																																																																										
≥ 50V	3%	6%	0603 ≥ 0.047μF; 0805 ≥ 0.18μF; 1206 ≥ 0.47μF																																																																									
		10%	0805 ≥ 1μF; 1210 ≥ 10μF																																																																									
25V	5%	14%	0603 ≥ 0.33μF; 1206 ≥ 4.7μF																																																																									
		15%	0402 ≥ 0.10μF; 0603 ≥ 0.47μF; 0805 ≥ 2.2μF; 1206 ≥ 6.8μF																																																																									
			10%	0603 ≥ 0.15μF; 0805 ≥ 0.68μF; 1206 ≥ 2.2μF; 1210 ≥ 4.7μF																																																																								
16V	5%	15%	0402 ≥ 0.033μF; 0603 ≥ 0.68μF; 0805 ≥ 2.2μF; 1206 ≥ 4.7μF; 1210 ≥ 22μF																																																																									
		10%	0402 ≥ 0.33μF; 0603 ≥ 0.33μF; 0805 ≥ 2.2μF; 1206 ≥ 2.2μF; 1210 ≥ 22μF																																																																									
10V	7.5%	15%	0402 ≥ 0.33μF; 0603 ≥ 0.33μF; 0805 ≥ 2.2μF; 1206 ≥ 2.2μF; 1210 ≥ 22μF																																																																									
		20%	0201 ≥ 0.1μF ;0402 ≥ 1μF																																																																									
6.3V	15%	30%	0402 ≥ 2.2μF ;0603 ≥ 10μF; 0805 ≥ 4.7μF; 1206 ≥ 47μF; 1210 ≥ 100μF																																																																									
		Rated vol.	D.F. ≤	Exception of D.F. ≤																																																																								
≥ 50V	7.5%	10%	0603 ≥ 0.1μF; 0805 ≥ 0.47μF; 1206 ≥ 4.7μF																																																																									
		10%	---																																																																									
25V	7.5%	10%	0402 ≥ 0.047μF; 0603 ≥ 0.1μF; 0805 ≥ 0.33μF; 1206 ≥ 1μF; 1210 ≥ 4.7μF																																																																									
		15%	0402 ≥ 0.068μF; 0603 ≥ 0.47μF; 1206 ≥ 4.7μF; 1210 ≥ 22μF																																																																									
			12.5%	0402 ≥ 0.068μF; 0603 ≥ 0.68μF																																																																								
16V (C < 1.0μF)	10%	20%	0402 ≥ 0.22μF																																																																									
		12.5%	0603 ≥ 2.2μF; 0805 ≥ 3.3μF; 1206 ≥ 10μF; 1210 ≥ 22μF; 1812 ≥ 47μF;																																																																									
10V	20%	30%	0402 ≥ 0.47μF																																																																									
6.3V	30%	---	---																																																																									
Rated voltage	Insulation Resistance																																																																											
100V: X7R	1GΩ or RxC ≥ 10 Ω-F whichever is smaller.																																																																											
16V: 0402 ≥ 0.22μF																																																																												
10V: 0201 ≥ 47nF; 0402 ≥ 0.47μF; 0603 ≥ 0.47μF; 0805 ≥ 2.2μF; 1206 ≥ 4.7μF; 1210 ≥ 47μF																																																																												
6.3V																																																																												

No	Item	Test Condition	Requirements																							
14	Humidity (Damp Heat) Load	* Test temp.: 40±2°C * Humidity: 90~95%RH * Test time: 500+24/-0 hrs. * To apply voltage : rated voltage. * Measurement to be made after keeping at room temp. for 24±2 hrs. (Class I) or 48±4 hrs. (Class II).	* No remarkable damage. Cap change: NP0: ±7.5% or 0.75pF whichever is larger. X7R, X5R: ≥10V, within ±12.5%; 6.3V, within ±25% Y5V: ≥10V, within ±30%; 6.3V, within +30/-40% Q/D.F. value: NP0: C≥30pF,Q≥200;C<30pF, Q≥100+10/3C X7R, X5R:																							
			<table border="1"> <thead> <tr> <th>Rated vol.</th> <th>D.F. ≤</th> <th>Exception of D.F. ≤</th> </tr> </thead> <tbody> <tr> <td>≥ 50V</td> <td>3%</td> <td>6% 0603 ≥ 0.047μF; 0805 ≥ 0.18μF; 1206 ≥ 0.47μF</td> </tr> <tr> <td rowspan="3">25V</td> <td rowspan="3">5%</td> <td>10% 0805 ≥ 1μF; 1210 ≥ 10μF</td> </tr> <tr> <td>14% 0603 ≥ 0.33μF; 1206 ≥ 4.7μF</td> </tr> <tr> <td>15% 0402 ≥ 0.10μF; 0603 ≥ 0.47μF; 0805 ≥ 2.2μF; 1206 ≥ 6.8μF</td> </tr> <tr> <td rowspan="2">16V</td> <td rowspan="2">5%</td> <td>10% 0603 ≥ 0.15μF; 0805 ≥ 0.68μF; 1206 ≥ 2.2μF; 1210 ≥ 4.7μF</td> </tr> <tr> <td>15% 0402 ≥ 0.033μF; 0603 ≥ 0.68μF; 0805 ≥ 2.2μF; 1206 ≥ 4.7μF; 1210 ≥ 22μF</td> </tr> <tr> <td rowspan="2">10V</td> <td rowspan="2">7.5%</td> <td>15% 0402 ≥ 0.33μF; 0603 ≥ 0.33μF; 0805 ≥ 2.2μF; 1206 ≥ 2.2μF; 1210 ≥ 22μF</td> </tr> <tr> <td>20% 0201 ≥ 0.1μF ;0402 ≥ 1μF</td> </tr> <tr> <td>6.3V</td> <td>15%</td> <td>30% 0402 ≥ 2.2μF ;0603 ≥ 10μF; 0805 ≥ 4.7μF; 1206 ≥ 47μF; 1210 ≥ 100μF</td> </tr> </tbody> </table>	Rated vol.	D.F. ≤	Exception of D.F. ≤	≥ 50V	3%	6% 0603 ≥ 0.047μF; 0805 ≥ 0.18μF; 1206 ≥ 0.47μF	25V	5%	10% 0805 ≥ 1μF; 1210 ≥ 10μF	14% 0603 ≥ 0.33μF; 1206 ≥ 4.7μF	15% 0402 ≥ 0.10μF; 0603 ≥ 0.47μF; 0805 ≥ 2.2μF; 1206 ≥ 6.8μF	16V	5%	10% 0603 ≥ 0.15μF; 0805 ≥ 0.68μF; 1206 ≥ 2.2μF; 1210 ≥ 4.7μF	15% 0402 ≥ 0.033μF; 0603 ≥ 0.68μF; 0805 ≥ 2.2μF; 1206 ≥ 4.7μF; 1210 ≥ 22μF	10V	7.5%	15% 0402 ≥ 0.33μF; 0603 ≥ 0.33μF; 0805 ≥ 2.2μF; 1206 ≥ 2.2μF; 1210 ≥ 22μF	20% 0201 ≥ 0.1μF ;0402 ≥ 1μF	6.3V	15%	30% 0402 ≥ 2.2μF ;0603 ≥ 10μF; 0805 ≥ 4.7μF; 1206 ≥ 47μF; 1210 ≥ 100μF	
			Rated vol.	D.F. ≤	Exception of D.F. ≤																					
			≥ 50V	3%	6% 0603 ≥ 0.047μF; 0805 ≥ 0.18μF; 1206 ≥ 0.47μF																					
			25V	5%	10% 0805 ≥ 1μF; 1210 ≥ 10μF																					
					14% 0603 ≥ 0.33μF; 1206 ≥ 4.7μF																					
					15% 0402 ≥ 0.10μF; 0603 ≥ 0.47μF; 0805 ≥ 2.2μF; 1206 ≥ 6.8μF																					
			16V	5%	10% 0603 ≥ 0.15μF; 0805 ≥ 0.68μF; 1206 ≥ 2.2μF; 1210 ≥ 4.7μF																					
					15% 0402 ≥ 0.033μF; 0603 ≥ 0.68μF; 0805 ≥ 2.2μF; 1206 ≥ 4.7μF; 1210 ≥ 22μF																					
			10V	7.5%	15% 0402 ≥ 0.33μF; 0603 ≥ 0.33μF; 0805 ≥ 2.2μF; 1206 ≥ 2.2μF; 1210 ≥ 22μF																					
20% 0201 ≥ 0.1μF ;0402 ≥ 1μF																										
6.3V	15%	30% 0402 ≥ 2.2μF ;0603 ≥ 10μF; 0805 ≥ 4.7μF; 1206 ≥ 47μF; 1210 ≥ 100μF																								
Y5V:																										
<table border="1"> <thead> <tr> <th>Rated vol.</th> <th>D.F. ≤</th> <th>Exception of D.F. ≤</th> </tr> </thead> <tbody> <tr> <td>≥ 50V</td> <td>7.5%</td> <td>10% 0603 ≥ 0.1μF; 0805 ≥ 0.47μF; 1206 ≥ 4.7μF</td> </tr> <tr> <td>35V</td> <td>10%</td> <td>---</td> </tr> <tr> <td rowspan="2">25V</td> <td rowspan="2">7.5%</td> <td>10% 0402 ≥ 0.047μF; 0603 ≥ 0.1μF; 0805 ≥ 0.33μF; 1206 ≥ 1μF; 1210 ≥ 4.7μF</td> </tr> <tr> <td>15% 0402 ≥ 0.068μF; 0603 ≥ 0.47μF; 1206 ≥ 4.7μF; 1210 ≥ 22μF</td> </tr> <tr> <td rowspan="2">16V (C<1.0μF)</td> <td rowspan="2">10%</td> <td>12.5% 0402 ≥ 0.068μF; 0603 ≥ 0.68μF</td> </tr> <tr> <td>20% 0402 ≥ 0.22μF</td> </tr> <tr> <td>16V (C ≥ 1.0μF)</td> <td>12.5%</td> <td>20% 0603 ≥ 2.2μF; 0805 ≥ 3.3μF; 1206 ≥ 10μF; 1210 ≥ 22μF; 1812 ≥ 47μF;</td> </tr> <tr> <td>10V</td> <td>20%</td> <td>30% 0402 ≥ 0.47μF</td> </tr> <tr> <td>6.3V</td> <td>30%</td> <td>---</td> </tr> </tbody> </table>	Rated vol.	D.F. ≤	Exception of D.F. ≤	≥ 50V	7.5%	10% 0603 ≥ 0.1μF; 0805 ≥ 0.47μF; 1206 ≥ 4.7μF	35V	10%	---	25V	7.5%	10% 0402 ≥ 0.047μF; 0603 ≥ 0.1μF; 0805 ≥ 0.33μF; 1206 ≥ 1μF; 1210 ≥ 4.7μF	15% 0402 ≥ 0.068μF; 0603 ≥ 0.47μF; 1206 ≥ 4.7μF; 1210 ≥ 22μF	16V (C<1.0μF)	10%	12.5% 0402 ≥ 0.068μF; 0603 ≥ 0.68μF	20% 0402 ≥ 0.22μF	16V (C ≥ 1.0μF)	12.5%	20% 0603 ≥ 2.2μF; 0805 ≥ 3.3μF; 1206 ≥ 10μF; 1210 ≥ 22μF; 1812 ≥ 47μF;	10V	20%	30% 0402 ≥ 0.47μF	6.3V	30%	---
Rated vol.	D.F. ≤	Exception of D.F. ≤																								
≥ 50V	7.5%	10% 0603 ≥ 0.1μF; 0805 ≥ 0.47μF; 1206 ≥ 4.7μF																								
35V	10%	---																								
25V	7.5%	10% 0402 ≥ 0.047μF; 0603 ≥ 0.1μF; 0805 ≥ 0.33μF; 1206 ≥ 1μF; 1210 ≥ 4.7μF																								
		15% 0402 ≥ 0.068μF; 0603 ≥ 0.47μF; 1206 ≥ 4.7μF; 1210 ≥ 22μF																								
16V (C<1.0μF)	10%	12.5% 0402 ≥ 0.068μF; 0603 ≥ 0.68μF																								
		20% 0402 ≥ 0.22μF																								
16V (C ≥ 1.0μF)	12.5%	20% 0603 ≥ 2.2μF; 0805 ≥ 3.3μF; 1206 ≥ 10μF; 1210 ≥ 22μF; 1812 ≥ 47μF;																								
10V	20%	30% 0402 ≥ 0.47μF																								
6.3V	30%	---																								
*I.R.: ≥10V, 500MΩ or 25 Ω-F whichever is smaller. Class II (X7R, X5R, Y5V)																										
<table border="1"> <thead> <tr> <th>Rated voltage</th> <th>Insulation Resistance</th> </tr> </thead> <tbody> <tr> <td>100V: X7R</td> <td rowspan="4">500MΩ or RxC ≥ 5 Ω-F whichever is smaller.</td> </tr> <tr> <td>16V: 0402 ≥ 0.22μF</td> </tr> <tr> <td>10V: 0201 ≥ 47nF; 0402 ≥ 0.47μF; 0603 ≥ 0.47μF ; 0805 ≥ 2.2μF; 1206 ≥ 4.7μF; 1210 ≥ 47μF</td> </tr> <tr> <td>6.3V</td> </tr> </tbody> </table>	Rated voltage	Insulation Resistance	100V: X7R	500MΩ or RxC ≥ 5 Ω-F whichever is smaller.	16V: 0402 ≥ 0.22μF	10V: 0201 ≥ 47nF; 0402 ≥ 0.47μF; 0603 ≥ 0.47μF ; 0805 ≥ 2.2μF; 1206 ≥ 4.7μF; 1210 ≥ 47μF	6.3V																			
Rated voltage	Insulation Resistance																									
100V: X7R	500MΩ or RxC ≥ 5 Ω-F whichever is smaller.																									
16V: 0402 ≥ 0.22μF																										
10V: 0201 ≥ 47nF; 0402 ≥ 0.47μF; 0603 ≥ 0.47μF ; 0805 ≥ 2.2μF; 1206 ≥ 4.7μF; 1210 ≥ 47μF																										
6.3V																										

No	Item	Test Condition	Requirements																																																																																																															
15.	High Temperature Load (Endurance)	<p>Test temp. : NP0, X7R/X7E: 125±3°C X5R, Y5V: 85±3°C Test time: 1000+24/-0 hrs. To apply voltage: (1) 6.3V or C ≥ 10µF or TT series: 150% of rated voltage. (2) 10V ≤ Ur < 500V: 200% of rated voltage. (3) 500V: 150% of rated voltage. (4) Ur ≥ 630V: 120% of rated voltage. (5) 100% of rated voltage for below range.</p> <table border="1"> <thead> <tr> <th>Size</th> <th>Dielectric</th> <th>Rated voltage</th> <th>Capacitance range</th> </tr> </thead> <tbody> <tr> <td>0201</td> <td>X5R</td> <td>6.3V, 10V</td> <td>C ≥ 0.1µF</td> </tr> <tr> <td>0402</td> <td>X5R, Y5V</td> <td>6.3V, 10V</td> <td>C ≥ 1.0µF</td> </tr> <tr> <td rowspan="2">0603</td> <td>X5R</td> <td rowspan="2">6.3V, 10V</td> <td>C ≥ 4.7µF</td> </tr> <tr> <td>Y5V</td> <td>TT ≥ 2.2µF</td> </tr> <tr> <td rowspan="2">0805</td> <td>X5R</td> <td rowspan="2">6.3V</td> <td>C ≥ 22µF</td> </tr> <tr> <td>Y5V</td> <td>TT ≥ 10µF</td> </tr> <tr> <td rowspan="2">1206</td> <td>X5R</td> <td rowspan="2">6.3V</td> <td>C ≥ 47µF</td> </tr> <tr> <td>Y5V</td> <td>TT ≥ 22µF</td> </tr> </tbody> </table> <p>(6) 150% of rated voltage for below range.</p> <table border="1"> <thead> <tr> <th>Size</th> <th>Dielectric</th> <th>Rated voltage</th> <th>Capacitance range</th> </tr> </thead> <tbody> <tr> <td rowspan="2">0402</td> <td>X5R</td> <td>10V, 16V</td> <td>C ≥ 0.22µF</td> </tr> <tr> <td>Y5V</td> <td>16V</td> <td>C ≥ 0.47µF</td> </tr> <tr> <td rowspan="2">0603</td> <td>X5R</td> <td>10V, 16V</td> <td>C ≥ 1.0µF</td> </tr> <tr> <td>Y5V</td> <td>16V</td> <td>C ≥ 2.2µF</td> </tr> <tr> <td rowspan="2">0805</td> <td>X5R</td> <td>10V</td> <td>C ≥ 4.7µF</td> </tr> <tr> <td>Y5V</td> <td>16V</td> <td>C ≥ 4.7µF</td> </tr> </tbody> </table> <p>* Measurement to be made after keeping at room temp. for 24±2 hrs. (Class I) or 48±4 hrs. (Class II).</p>	Size	Dielectric	Rated voltage	Capacitance range	0201	X5R	6.3V, 10V	C ≥ 0.1µF	0402	X5R, Y5V	6.3V, 10V	C ≥ 1.0µF	0603	X5R	6.3V, 10V	C ≥ 4.7µF	Y5V	TT ≥ 2.2µF	0805	X5R	6.3V	C ≥ 22µF	Y5V	TT ≥ 10µF	1206	X5R	6.3V	C ≥ 47µF	Y5V	TT ≥ 22µF	Size	Dielectric	Rated voltage	Capacitance range	0402	X5R	10V, 16V	C ≥ 0.22µF	Y5V	16V	C ≥ 0.47µF	0603	X5R	10V, 16V	C ≥ 1.0µF	Y5V	16V	C ≥ 2.2µF	0805	X5R	10V	C ≥ 4.7µF	Y5V	16V	C ≥ 4.7µF	<p>* No remarkable damage. Cap change: NP0: ±3.0% or ±0.3pF whichever is larger X7R, X5R: ≥10V, within ±12.5%; 6.3V, within ±25% Y5V: ≥10V, within ±30%; 6.3V, within +30/-40% Q/D.F. value: NP0: More than 30pF, Q ≥ 350 10pF ≤ C < 30pF, Q ≥ 275+2.5C Less than 10pF, Q ≥ 200+10C X7R, X5R:</p> <table border="1"> <thead> <tr> <th>Rated vol.</th> <th>D.F. ≤</th> <th>Exception of D.F. ≤</th> </tr> </thead> <tbody> <tr> <td>≥ 50V</td> <td>3%</td> <td>6% 0603 ≥ 0.047µF; 0805 ≥ 0.18µF; 1206 ≥ 0.47µF</td> </tr> <tr> <td rowspan="2">25V</td> <td rowspan="2">5%</td> <td>10% 0805 ≥ 1µF; 1210 ≥ 10µF</td> </tr> <tr> <td>14% 0603 ≥ 0.33µF; 1206 ≥ 4.7µF</td> </tr> <tr> <td rowspan="2">16V</td> <td rowspan="2">5%</td> <td>10% 0402 ≥ 0.10µF; 0603 ≥ 0.47µF; 0805 ≥ 2.2µF; 1206 ≥ 6.8µF</td> </tr> <tr> <td>15% 0603 ≥ 0.15µF; 0805 ≥ 0.68µF; 1206 ≥ 2.2µF; 1210 ≥ 4.7µF</td> </tr> <tr> <td rowspan="2">10V</td> <td rowspan="2">7.5%</td> <td>10% 0402 ≥ 0.033µF; 0603 ≥ 0.68µF; 0805 ≥ 2.2µF; 1206 ≥ 4.7µF; 1210 ≥ 22µF</td> </tr> <tr> <td>15% 0402 ≥ 0.33µF; 0603 ≥ 0.33µF; 0805 ≥ 2.2µF; 1206 ≥ 2.2µF; 1210 ≥ 22µF</td> </tr> <tr> <td rowspan="2">6.3V</td> <td rowspan="2">15%</td> <td>20% 0201 ≥ 0.1µF; 0402 ≥ 1µF</td> </tr> <tr> <td>30% 0402 ≥ 2.2µF; 0603 ≥ 10µF; 0805 ≥ 4.7µF; 1206 ≥ 47µF; 1210 ≥ 100µF</td> </tr> </tbody> </table> <p>Y5V:</p> <table border="1"> <thead> <tr> <th>Rated vol.</th> <th>D.F. ≤</th> <th>Exception of D.F. ≤</th> </tr> </thead> <tbody> <tr> <td>≥ 50V</td> <td>7.5%</td> <td>10% 0603 ≥ 0.1µF; 0805 ≥ 0.47µF; 1206 ≥ 4.7µF</td> </tr> <tr> <td>35V</td> <td>10%</td> <td>---</td> </tr> <tr> <td rowspan="2">25V</td> <td rowspan="2">7.5%</td> <td>10% 0402 ≥ 0.047µF; 0603 ≥ 0.1µF; 0805 ≥ 0.33µF; 1206 ≥ 1µF; 1210 ≥ 4.7µF</td> </tr> <tr> <td>15% 0402 ≥ 0.068µF; 0603 ≥ 0.47µF; 1206 ≥ 4.7µF; 1210 ≥ 22µF</td> </tr> <tr> <td rowspan="2">16V (C < 1.0µF)</td> <td rowspan="2">10%</td> <td>12.5% 0402 ≥ 0.068µF; 0603 ≥ 0.68µF</td> </tr> <tr> <td>20% 0402 ≥ 0.22µF</td> </tr> <tr> <td rowspan="2">16V (C ≥ 1.0µF)</td> <td rowspan="2">12.5%</td> <td>20% 0603 ≥ 2.2µF; 0805 ≥ 3.3µF; 1206 ≥ 10µF; 1210 ≥ 22µF; 1812 ≥ 47µF</td> </tr> <tr> <td>30% 0402 ≥ 0.47µF</td> </tr> <tr> <td>10V</td> <td>20%</td> <td>---</td> </tr> <tr> <td>6.3V</td> <td>30%</td> <td>---</td> </tr> </tbody> </table> <p>*I.R.: ≥10V, 1GΩ or 50 Ω-F whichever is smaller. Class II (X7R, X5R, Y5V)</p> <table border="1"> <thead> <tr> <th>Rated voltage</th> <th>Insulation Resistance</th> </tr> </thead> <tbody> <tr> <td>100V: X7R</td> <td rowspan="4">1GΩ or Rx C ≥ 10 Ω-F whichever is smaller.</td> </tr> <tr> <td>16V: 0402 ≥ 0.22µF</td> </tr> <tr> <td>10V: 0201 ≥ 47nF; 0402 ≥ 0.47µF; 0603 ≥ 0.47µF; 0805 ≥ 2.2µF; 1206 ≥ 4.7µF; 1210 ≥ 47µF</td> </tr> <tr> <td>6.3V</td> </tr> </tbody> </table>	Rated vol.	D.F. ≤	Exception of D.F. ≤	≥ 50V	3%	6% 0603 ≥ 0.047µF; 0805 ≥ 0.18µF; 1206 ≥ 0.47µF	25V	5%	10% 0805 ≥ 1µF; 1210 ≥ 10µF	14% 0603 ≥ 0.33µF; 1206 ≥ 4.7µF	16V	5%	10% 0402 ≥ 0.10µF; 0603 ≥ 0.47µF; 0805 ≥ 2.2µF; 1206 ≥ 6.8µF	15% 0603 ≥ 0.15µF; 0805 ≥ 0.68µF; 1206 ≥ 2.2µF; 1210 ≥ 4.7µF	10V	7.5%	10% 0402 ≥ 0.033µF; 0603 ≥ 0.68µF; 0805 ≥ 2.2µF; 1206 ≥ 4.7µF; 1210 ≥ 22µF	15% 0402 ≥ 0.33µF; 0603 ≥ 0.33µF; 0805 ≥ 2.2µF; 1206 ≥ 2.2µF; 1210 ≥ 22µF	6.3V	15%	20% 0201 ≥ 0.1µF; 0402 ≥ 1µF	30% 0402 ≥ 2.2µF; 0603 ≥ 10µF; 0805 ≥ 4.7µF; 1206 ≥ 47µF; 1210 ≥ 100µF	Rated vol.	D.F. ≤	Exception of D.F. ≤	≥ 50V	7.5%	10% 0603 ≥ 0.1µF; 0805 ≥ 0.47µF; 1206 ≥ 4.7µF	35V	10%	---	25V	7.5%	10% 0402 ≥ 0.047µF; 0603 ≥ 0.1µF; 0805 ≥ 0.33µF; 1206 ≥ 1µF; 1210 ≥ 4.7µF	15% 0402 ≥ 0.068µF; 0603 ≥ 0.47µF; 1206 ≥ 4.7µF; 1210 ≥ 22µF	16V (C < 1.0µF)	10%	12.5% 0402 ≥ 0.068µF; 0603 ≥ 0.68µF	20% 0402 ≥ 0.22µF	16V (C ≥ 1.0µF)	12.5%	20% 0603 ≥ 2.2µF; 0805 ≥ 3.3µF; 1206 ≥ 10µF; 1210 ≥ 22µF; 1812 ≥ 47µF	30% 0402 ≥ 0.47µF	10V	20%	---	6.3V	30%	---	Rated voltage	Insulation Resistance	100V: X7R	1GΩ or Rx C ≥ 10 Ω-F whichever is smaller.	16V: 0402 ≥ 0.22µF	10V: 0201 ≥ 47nF; 0402 ≥ 0.47µF; 0603 ≥ 0.47µF; 0805 ≥ 2.2µF; 1206 ≥ 4.7µF; 1210 ≥ 47µF	6.3V
Size	Dielectric	Rated voltage	Capacitance range																																																																																																															
0201	X5R	6.3V, 10V	C ≥ 0.1µF																																																																																																															
0402	X5R, Y5V	6.3V, 10V	C ≥ 1.0µF																																																																																																															
0603	X5R	6.3V, 10V	C ≥ 4.7µF																																																																																																															
	Y5V		TT ≥ 2.2µF																																																																																																															
0805	X5R	6.3V	C ≥ 22µF																																																																																																															
	Y5V		TT ≥ 10µF																																																																																																															
1206	X5R	6.3V	C ≥ 47µF																																																																																																															
	Y5V		TT ≥ 22µF																																																																																																															
Size	Dielectric	Rated voltage	Capacitance range																																																																																																															
0402	X5R	10V, 16V	C ≥ 0.22µF																																																																																																															
	Y5V	16V	C ≥ 0.47µF																																																																																																															
0603	X5R	10V, 16V	C ≥ 1.0µF																																																																																																															
	Y5V	16V	C ≥ 2.2µF																																																																																																															
0805	X5R	10V	C ≥ 4.7µF																																																																																																															
	Y5V	16V	C ≥ 4.7µF																																																																																																															
Rated vol.	D.F. ≤	Exception of D.F. ≤																																																																																																																
≥ 50V	3%	6% 0603 ≥ 0.047µF; 0805 ≥ 0.18µF; 1206 ≥ 0.47µF																																																																																																																
25V	5%	10% 0805 ≥ 1µF; 1210 ≥ 10µF																																																																																																																
		14% 0603 ≥ 0.33µF; 1206 ≥ 4.7µF																																																																																																																
16V	5%	10% 0402 ≥ 0.10µF; 0603 ≥ 0.47µF; 0805 ≥ 2.2µF; 1206 ≥ 6.8µF																																																																																																																
		15% 0603 ≥ 0.15µF; 0805 ≥ 0.68µF; 1206 ≥ 2.2µF; 1210 ≥ 4.7µF																																																																																																																
10V	7.5%	10% 0402 ≥ 0.033µF; 0603 ≥ 0.68µF; 0805 ≥ 2.2µF; 1206 ≥ 4.7µF; 1210 ≥ 22µF																																																																																																																
		15% 0402 ≥ 0.33µF; 0603 ≥ 0.33µF; 0805 ≥ 2.2µF; 1206 ≥ 2.2µF; 1210 ≥ 22µF																																																																																																																
6.3V	15%	20% 0201 ≥ 0.1µF; 0402 ≥ 1µF																																																																																																																
		30% 0402 ≥ 2.2µF; 0603 ≥ 10µF; 0805 ≥ 4.7µF; 1206 ≥ 47µF; 1210 ≥ 100µF																																																																																																																
Rated vol.	D.F. ≤	Exception of D.F. ≤																																																																																																																
≥ 50V	7.5%	10% 0603 ≥ 0.1µF; 0805 ≥ 0.47µF; 1206 ≥ 4.7µF																																																																																																																
35V	10%	---																																																																																																																
25V	7.5%	10% 0402 ≥ 0.047µF; 0603 ≥ 0.1µF; 0805 ≥ 0.33µF; 1206 ≥ 1µF; 1210 ≥ 4.7µF																																																																																																																
		15% 0402 ≥ 0.068µF; 0603 ≥ 0.47µF; 1206 ≥ 4.7µF; 1210 ≥ 22µF																																																																																																																
16V (C < 1.0µF)	10%	12.5% 0402 ≥ 0.068µF; 0603 ≥ 0.68µF																																																																																																																
		20% 0402 ≥ 0.22µF																																																																																																																
16V (C ≥ 1.0µF)	12.5%	20% 0603 ≥ 2.2µF; 0805 ≥ 3.3µF; 1206 ≥ 10µF; 1210 ≥ 22µF; 1812 ≥ 47µF																																																																																																																
		30% 0402 ≥ 0.47µF																																																																																																																
10V	20%	---																																																																																																																
6.3V	30%	---																																																																																																																
Rated voltage	Insulation Resistance																																																																																																																	
100V: X7R	1GΩ or Rx C ≥ 10 Ω-F whichever is smaller.																																																																																																																	
16V: 0402 ≥ 0.22µF																																																																																																																		
10V: 0201 ≥ 47nF; 0402 ≥ 0.47µF; 0603 ≥ 0.47µF; 0805 ≥ 2.2µF; 1206 ≥ 4.7µF; 1210 ≥ 47µF																																																																																																																		
6.3V																																																																																																																		

APPENDIXES

■ **Tape & reel dimensions**

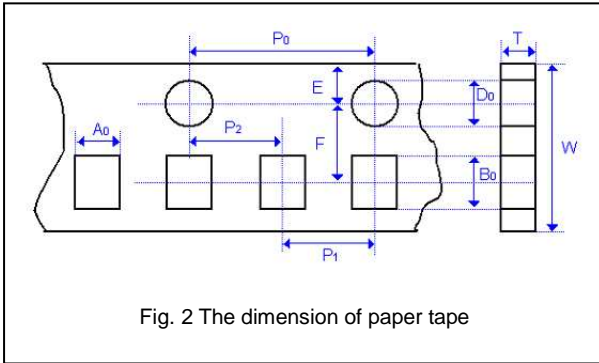

Fig. 2 The dimension of paper tape

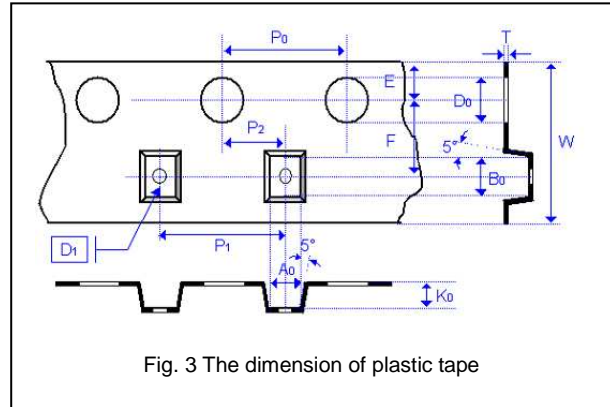

Fig. 3 The dimension of plastic tape

Size	0402	0603	0805			1206			1210		1812
Thickness	N	S, X	A	B	C, D, I	B	C, J, D	G	C, D, G	M	D, K
A ₀	0.62±0.05	1.02±0.05	1.50±0.10	1.50±0.10	<1.57	2.00±0.10	<1.85	<1.95	<2.97	<2.97	<3.81
B ₀	1.12±0.05	1.80±0.05	2.30±0.10	2.30±0.10	<2.40	3.50±0.10	<3.46	<3.67	<3.73	<3.73	<5.30
T	0.60±0.05	0.95±0.05	0.75±0.05	0.95±0.05	0.23±0.05	0.95±0.05	0.23±0.05	0.23±0.05	0.23±0.05	0.23±0.05	0.25±0.05
K ₀	-	-	-	-	<2.50	-	<2.50	<2.50	<2.50	<3.00	<2.50
W	8.00±0.10	8.00±0.10	8.00±0.10	8.00±0.10	8.00±0.10	8.00±0.10	8.00±0.10	8.00±0.10	8.00±0.10	8.00±0.10	12.0±0.20
P ₀	4.00±0.10	4.00±0.10	4.00±0.10	4.00±0.10	4.00±0.10	4.00±0.10	4.00±0.10	4.00±0.10	4.00±0.10	4.00±0.10	4.00±0.10
10xP ₀	40.0±0.10	40.0±0.10	40.0±0.10	40.0±0.10	40.0±0.10	40.0±0.10	40.0±0.10	40.0±0.10	40.0±0.10	40.0±0.10	40.0±0.10
P ₁	2.00±0.05	4.00±0.10	4.00±0.10	4.00±0.10	4.00±0.10	4.00±0.10	4.00±0.10	4.00±0.10	4.00±0.10	4.00±0.10	8.00±0.10
P ₂	2.00±0.05	2.00±0.05	2.00±0.05	2.00±0.05	2.00±0.05	2.00±0.05	2.00±0.05	2.00±0.05	2.00±0.05	2.00±0.05	2.00±0.05
D ₀	1.55±0.05	1.55±0.05	1.55±0.05	1.55±0.05	1.50±0.05	1.50±0.05	1.50±0.05	1.50±0.05	1.50±0.05	1.50±0.05	1.50±0.05
D ₁	-	-	-	-	1.00±0.10	-	1.00±0.10	1.00±0.10	1.00±0.10	1.00±0.10	1.50±0.10
E	1.75±0.05	1.75±0.05	1.75±0.05	1.75±0.05	1.75±0.10	1.75±0.10	1.75±0.10	1.75±0.10	1.75±0.10	1.75±0.10	1.75±0.10
F	3.50±0.05	3.50±0.05	3.50±0.05	3.50±0.05	3.50±0.05	3.50±0.05	3.50±0.05	3.50±0.05	3.50±0.05	3.50±0.05	5.50±0.05

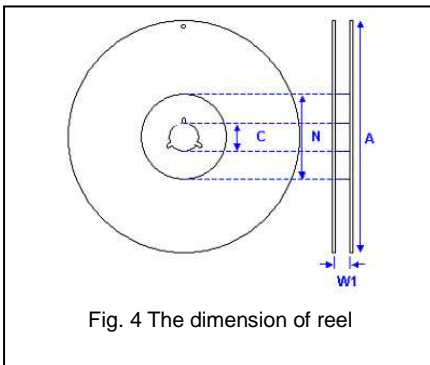
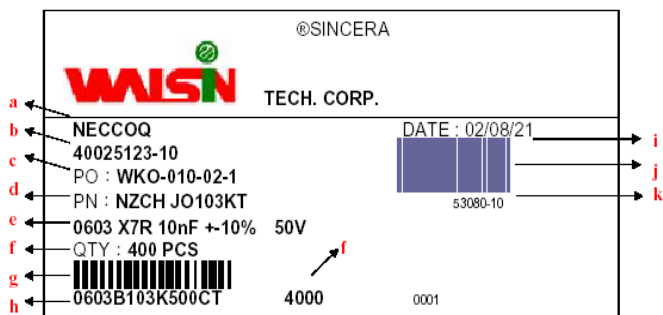

Fig. 4 The dimension of reel

Size	0402, 0603, 0805, 1206, 1210			1812
Reel size	7"	10"	13"	7"
C	13.0+0.5/-0.2	13.0+0.5/-0.2	13.0+0.5/-0.2	13.0+0.5/-0.2
W ₁	8.4+1.5/-0	8.4+1.5/-0	8.4+1.5/-0	12.4+2.0/-0
A	178.0±0.10	250.0±1.0	330.0±1.0	178.0±0.10
N	60.0+1.0/-0	100.0±1.0	100±1.0	60.0+1.0/-0

▣ Description of customer label



- a. Customer name
- b. WTC order series and item number
- c. Customer P/O
- d. Customer P/N
- e. Description of product
- f. Quantity
- g. Bar code including quantity & WTC P/N or customer
- h. WTC P/N
- i. Shipping date
- j. Order bar code including series and item numbers
- k. Serial number of label

▣ Constructions

No.	Name	NPO*	NPO, X7R, Y5V
①	Ceramic material	BaTiO ₃ based	
②	Inner electrode	AgPd alloy	Ni
③	Termination	Inner layer	Ag Cu
④		Middle layer	Ni
⑤		Outer layer	Sn

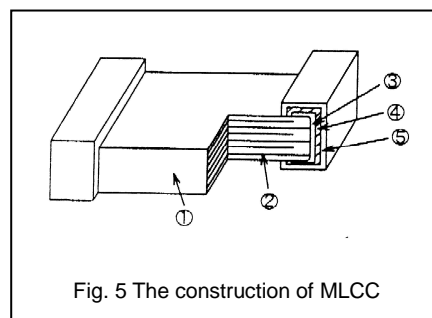

Fig. 5 The construction of MLCC

* Partial NPO items are with Ag/Ni/Sn terminations, please ref to product range of NPO dielectric for detail.

▣ Storage and handling conditions

- (1) To store products at 5 to 40°C ambient temperature and 20 to 70% related humidity conditions.
- (2) The product is recommended to be used within one year after shipment. Check solderability in case of shelf life extension is needed.

Cautions:

- a. Don't store products in a corrosive environment such as sulfide, chloride gas, or acid. It may cause oxidization of electrode, which easily be resulted in poor soldering.
- b. To store products on the shelf and avoid exposure to moisture.
- c. Don't expose products to excessive shock, vibration, direct sunlight and so on.

☐ Recommended soldering conditions

The lead-free termination MLCCs are not only to be used on SMT against lead-free solder paste, but also suitable against lead-containing solder paste. If the optimized solder joint is requested, increasing soldering time, temperature and concentration of N₂ within oven are recommended.

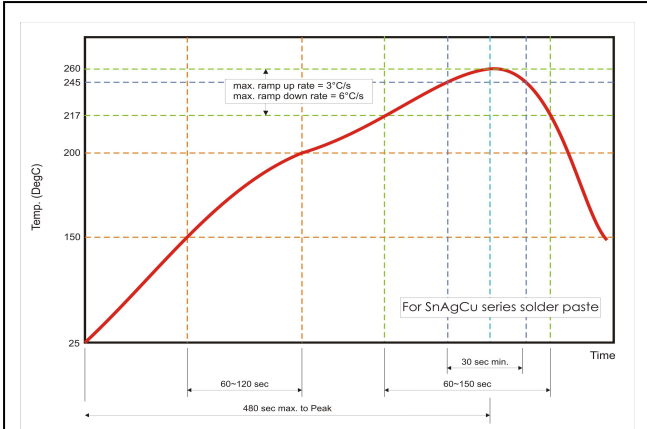

Fig. 6 Recommended reflow soldering profile for SMT process with SnAgCu series solder paste.

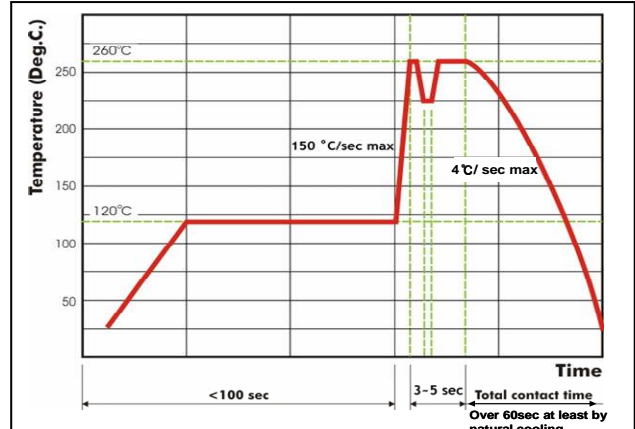

Fig. 7 Recommended wave soldering profile for SMT process with SnAgCu series solder.