

TOSHIBA RECTIFIER STACK SILICON DIFFUSED TYPE

# 1B4B42, 1G4B42, 1J4B42

SINGLE PHASE BRIDGE RECTIFIER APPLICATIONS

Unit in mm

- Repetitive Peak Reverse Voltage :  $V_{RRM}=100\sim600V$
- Average Output Rectified Current :  $I_O=1.0A$  ( $T_a=25^\circ C$ )

**POLARITY**

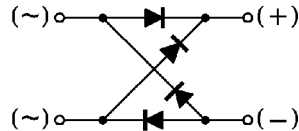

**MAXIMUM RATINGS**

CHARACTERISTIC		SYMBOL	RATINGS	UNIT
Repetitive Peak Reverse Voltage	1B4B42	$V_{RRM}$	100	V
	1G4B42		400	
	1J4B42		600	
Average Output Rectified Current		$I_O$	1.0	A
Peak One Cycle Surge Forward Current (Non Repetitive)		$I_{FSM}$	30 (50Hz)	A
			33 (60Hz)	
Junction Temperature		$T_j$	-40~150	$^\circ C$
Storage Temperature Range		$T_{stg}$	-40~150	$^\circ C$

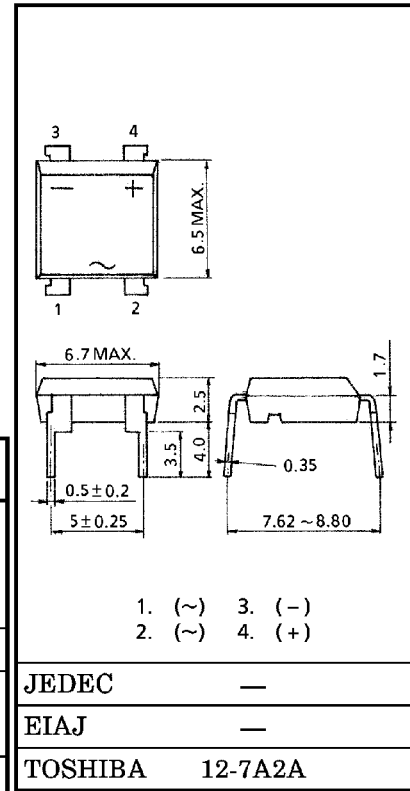

JEDEC	—
EIAJ	—
TOSHIBA	12-7A2A

Weight : 0.3g

**ELECTRICAL CHARACTERISTICS ( $T_a = 25^\circ C$ )**

CHARACTERISTIC	SYMBOL	TEST CONDITION	MIN.	TYP.	MAX.	UNIT
Peak Forward Voltage	$V_{FM}$	$I_{FM}=0.5A$	—	—	1.0	V
Repetitive Peak Reverse Current	$I_{RRM}$	$V_{RRM}=\text{Rated}$	—	—	10	$\mu A$
Thermal Resistance (Junction to Ambient)	$R_{th(j-a)}$	DC	—	—	75	$^\circ C / W$

**MARK**

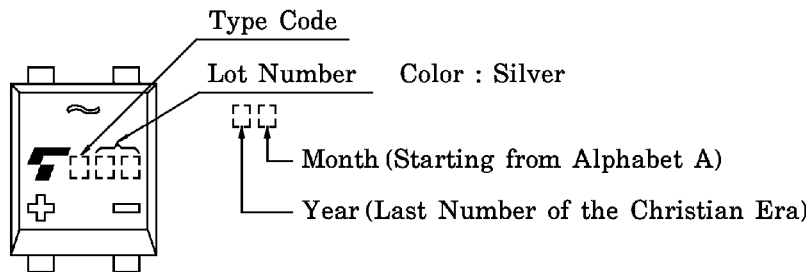

CODE	TYPE
B	1B4B42
G	1G4B42
J	1J4B42

961001EAA2

● TOSHIBA is continually working to improve the quality and the reliability of its products. Nevertheless, semiconductor devices in general can malfunction or fail due to their inherent electrical sensitivity and vulnerability to physical stress. It is the responsibility of the buyer, when utilizing TOSHIBA products, to observe standards of safety, and to avoid situations in which a malfunction or failure of a TOSHIBA product could cause loss of human life, bodily injury or damage to property. In developing your designs, please ensure that TOSHIBA products are used within specified operating ranges as set forth in the most recent products specifications. Also, please keep in mind the precautions and conditions set forth in the TOSHIBA Semiconductor Reliability Handbook.

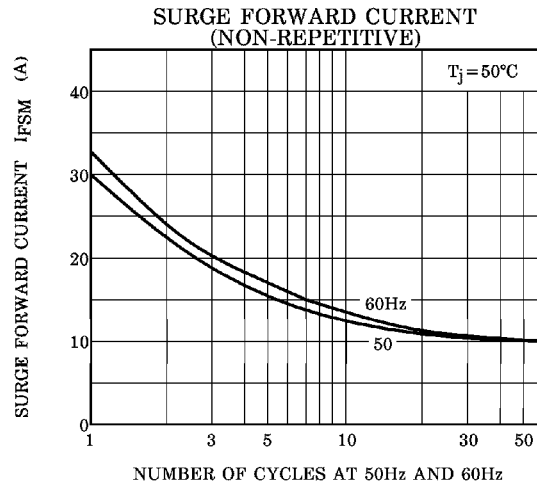
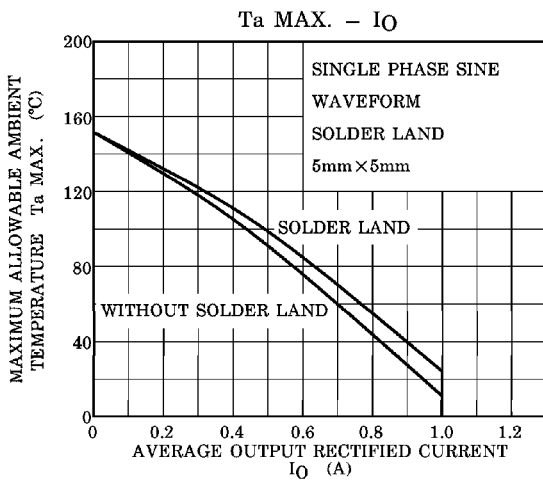
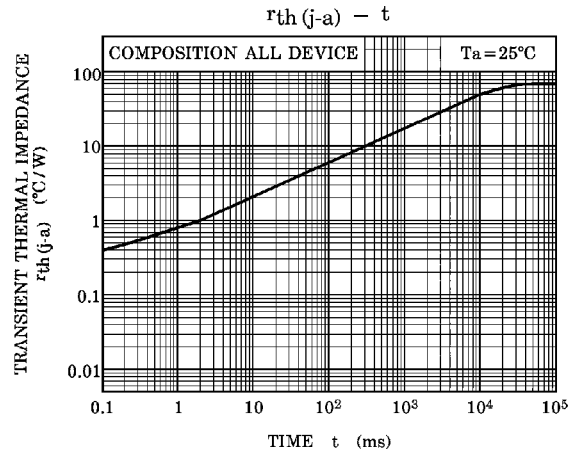
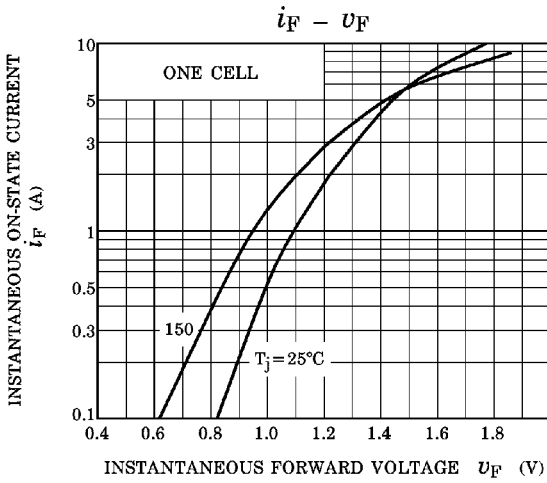

961001EAA2'

- The information contained herein is presented only as a guide for the applications of our products. No responsibility is assumed by TOSHIBA CORPORATION for any infringements of intellectual property or other rights of the third parties which may result from its use. No license is granted by implication or otherwise under any intellectual property or other rights of TOSHIBA CORPORATION or others.
- The information contained herein is subject to change without notice.