

MG300Q2YS60A(1200V/300A 2in1)

High Power Switching Applications

Motor Control Applications

- Integrates a complete half bridge power circuit and fault-signal output circuit in one package.
(short circuit and over temperature)
- The electrodes are isolated from case.
- Low thermal resistance
- $V_{CE(sat)} = 2.4\text{ V (typ.)}$

Equivalent Circuit

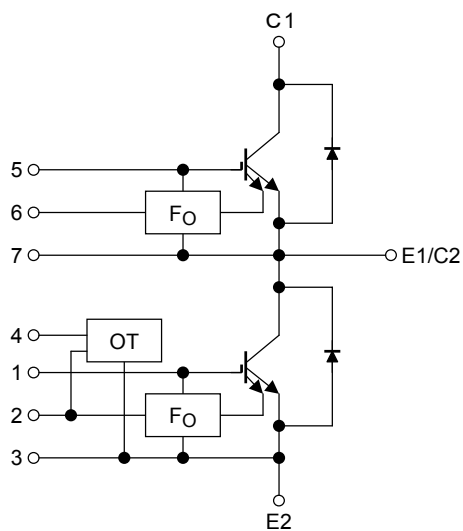

Signal terminal

1.	G (L)	2.	F _O (L)	3.	E (L)	4.	V _D
5.	G (H)	6.	F _O (H)	7.	E (H)	8.	Open

Package Dimensions: 2-123C1B

Unit: mm

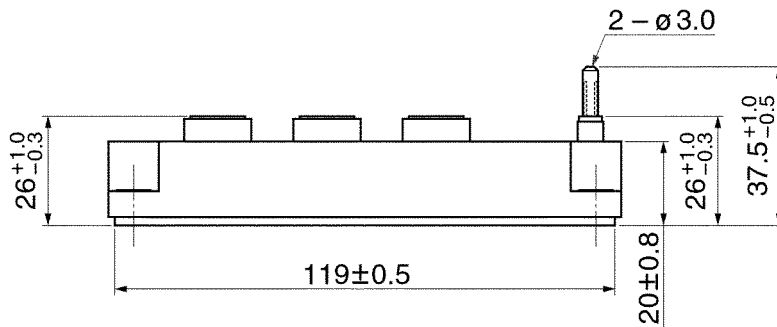
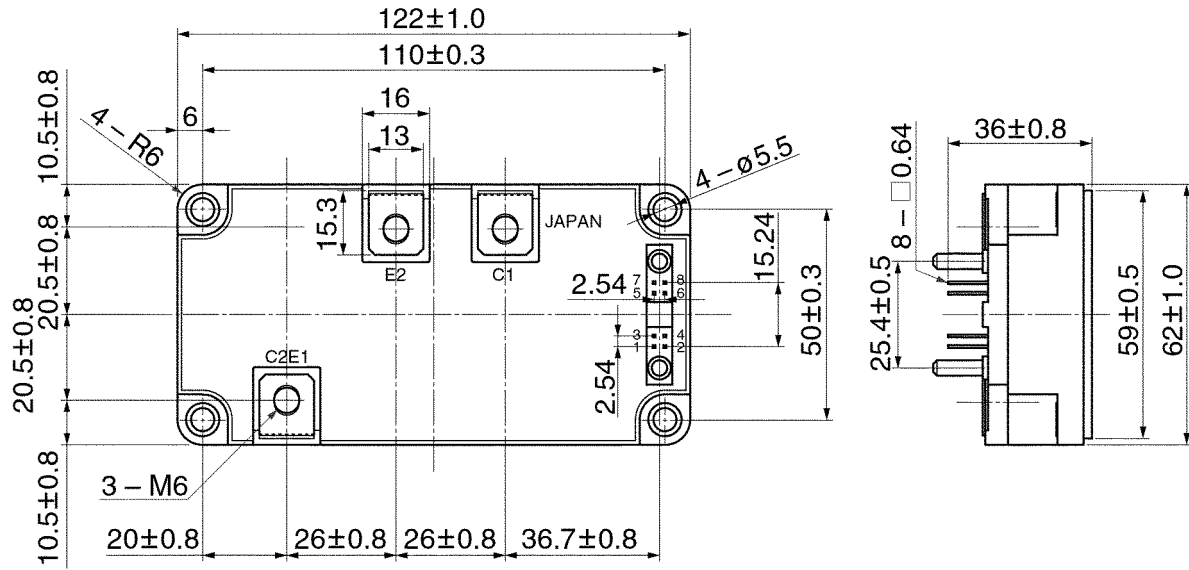

- | | | | | | | | |
|----|-------|----|--------------------|----|-------|----|----------------|
| 1. | G (L) | 2. | F _O (L) | 3. | E (L) | 4. | V _D |
| 5. | G (H) | 6. | F _O (H) | 7. | E (H) | 8. | Open |

Signal Terminal Layout

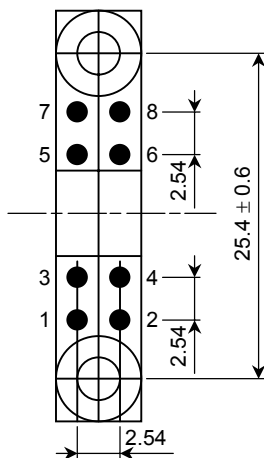

- | | | | | | | | |
|----|-------|----|--------------------|----|-------|----|----------------|
| 1. | G (L) | 2. | F _O (L) | 3. | E (L) | 4. | V _D |
| 5. | G (H) | 6. | F _O (H) | 7. | E (H) | 8. | Open |

Weight: 375 g

Maximum Ratings (Ta = 25°C)

Stage	Characteristics	Symbol	Rating	Unit	
Inverter	Collector-emitter voltage	V_{CES}	1200	V	
	Gate-emitter voltage	V_{GES}	±20	V	
	Collector current	DC	I_C	300	A
		1 ms	I_{CP}	600	
	Forward current	DC	I_F	300	A
		1 ms	I_{FM}	600	
Collector power dissipation (Tc = 25°C)		P_C	2800	W	
Control	Control voltage (OT)	V_D	20	V	
	Fault input voltage	V_{FO}	20	V	
	Fault input current	I_{FO}	20	mA	
Module	Junction temperature	T_j	150	°C	
	Storage temperature range	T_{stg}	-40~125	°C	
	Operation temperature range	T_{ope}	-20~100	°C	
	Isolation voltage	V_{isol}	2500 (AC 1 min)	V	
	Screw torque	—	3 (M5)	N·m	

Electrical Characteristics (Tj = 25°C)

1. Inverter Stage

Characteristics	Symbol	Test Condition	Min	Typ.	Max	Unit			
Gate leakage current	I_{GES}	$V_{GE} = \pm 20 \text{ V}, V_{CE} = 0$	—	—	+3/-4	mA			
		$V_{GE} = +10 \text{ V}, V_{CE} = 0$	—	—	100	nA			
Collector cut-off current	I_{CES}	$V_{CE} = 1200 \text{ V}, V_{GE} = 0$	—	—	1.0	mA			
Gate-emitter cut-off voltage	$V_{GE} \text{ (off)}$	$V_{CE} = 5 \text{ V}, I_C = 300 \text{ mA}$	6.0	7.0	8.0	V			
Collector-emitter saturation voltage	$V_{CE} \text{ (sat)}$	$V_{GE} = 15 \text{ V}, I_C = 300 \text{ A}$	$T_j = 25^\circ\text{C}$	—	2.4	2.8	V		
			$T_j = 125^\circ\text{C}$	—	—	3.2			
Input capacitance	C_{ies}	$V_{CE} = 10 \text{ V}, V_{GE} = 0, f = 1 \text{ MHz}$	—	21000	—	pF			
Switching time	Turn-on delay time	$V_{CC} = 600 \text{ V}, I_C = 300 \text{ A}$ $V_{GE} = \pm 15 \text{ V}, R_G = 6.8 \Omega$ (Note 1)	0.10	—	1.00	μs			
	Turn-off time						—	—	2.00
	Fall time						—	—	0.50
Reverse recovery time	t_{rr}		—	—	0.50				
Forward voltage	V_F	$I_F = 300 \text{ A}$	—	2.1	2.6	V			

Note 1: Switching time test circuit & timing chart

2. Control (Tc = 25°C)

Characteristics	Symbol	Test Condition	Min	Typ.	Max	Unit
Fault output current	OC	$V_{GE} = 15 \text{ V}$	360	—	—	A
Over temperature	OT	—	100	—	125	°C
Fault output delay time	$t_d \text{ (Fo)}$	$V_{CC} = 600 \text{ V}, V_{GE} = \pm 15 \text{ V}$	—	—	8	μs

3. Module (Tc = 25°C)

Characteristics	Symbol	Test Condition	Min	Typ.	Max	Unit
Junction to case thermal resistance	$R_{th(j-c)}$	Inverter IGBT stage	—	—	0.044	°C/W
		Inverter FRD stage	—	—	0.068	
Case to fin thermal resistance	$R_{th(c-f)}$	With silicon compound	—	0.013	—	°C/W

Switching Time Test Circuit

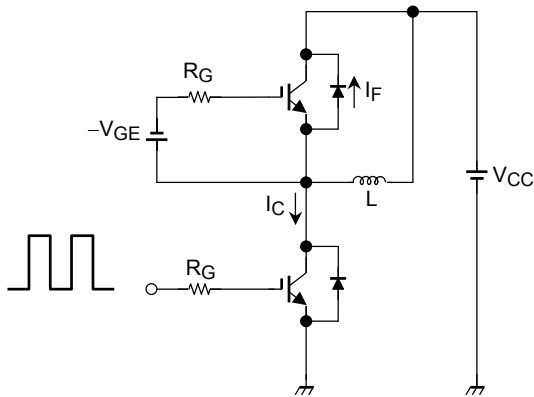

Timing Chart

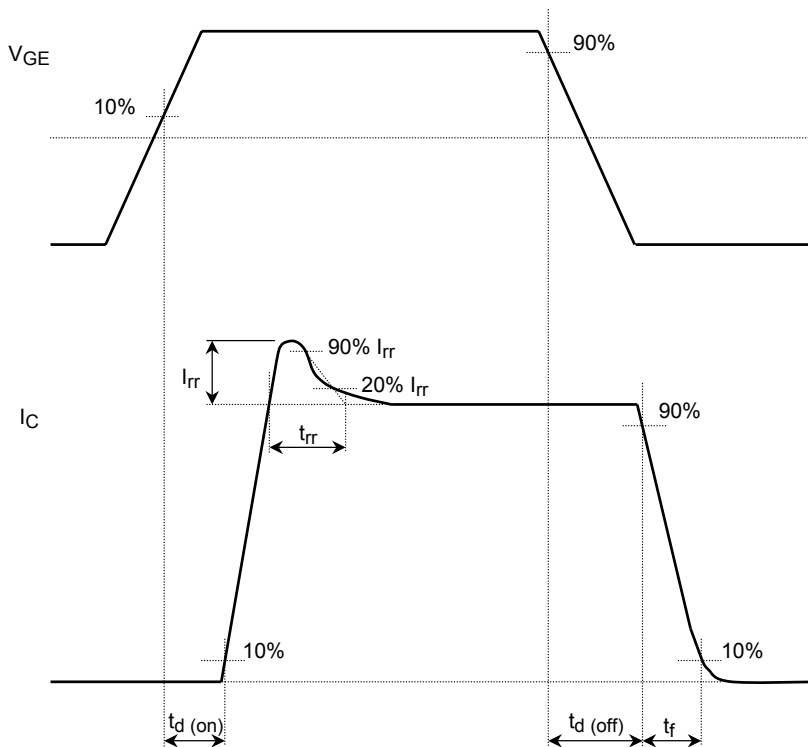

Remark

<Short circuit capability condition>

- Short circuit capability is 6 μ s after fault output signal.
Please keep following condition to use fault output signal.
 - $V_{CC} \leq 750$ V
 - 14.8 V $\leq V_{GE} \leq 17.0$ V
 - $R_G \geq 6.8$ Ω
 - $T_j \leq 125^\circ$ C

<Gate voltage>

- To use this product, V_{GE} must be provided higher than 14.8 V.
In case V_{GE} is less than 14.8 V, fault signal FO may not be output even under error conditions.

<Recommended conditions for application>

Characteristics	Symbol	Min	Typ.	Max	Unit
P-N power terminal supply voltage	V_{CC}	—	600	750	V
Gate voltage	V_{GE}	14.8	15	17	V
Gate resistance	R_G	6.8	—	—	Ω
Switching frequency	f_c	—	—	20	kHz

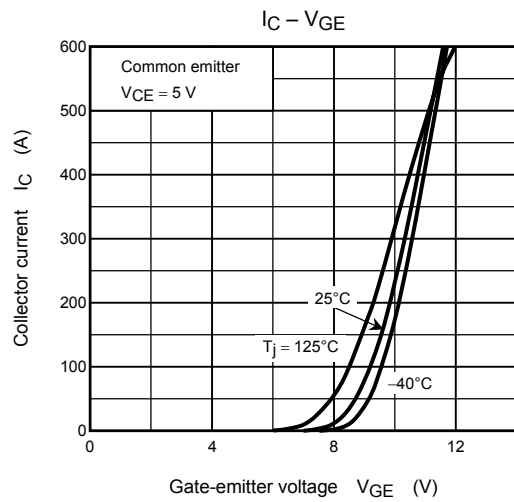
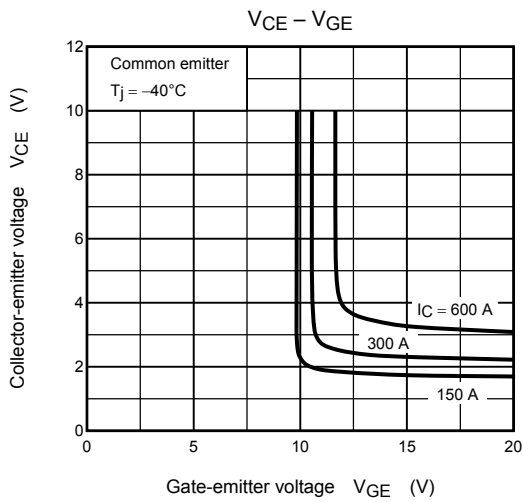
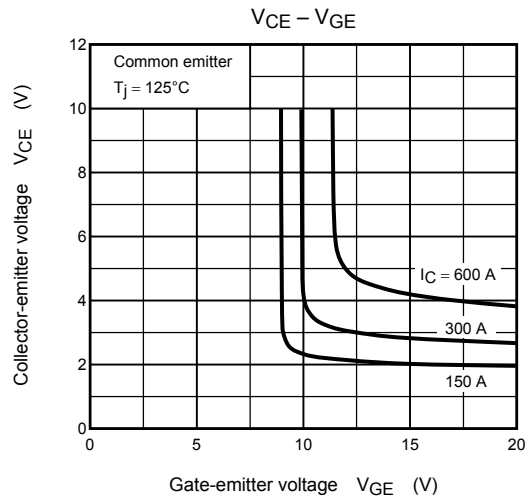
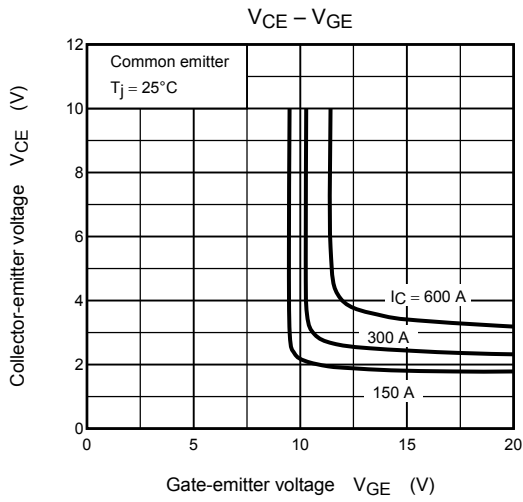
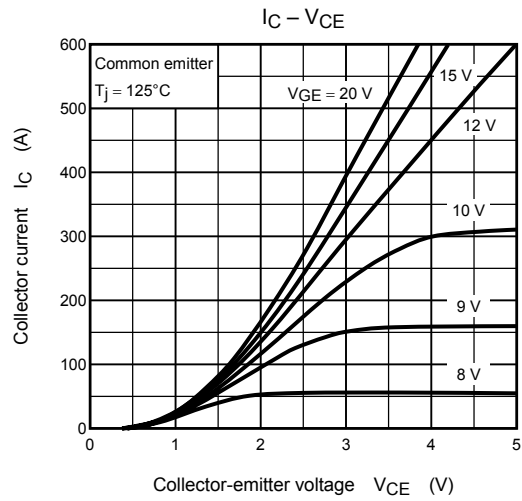
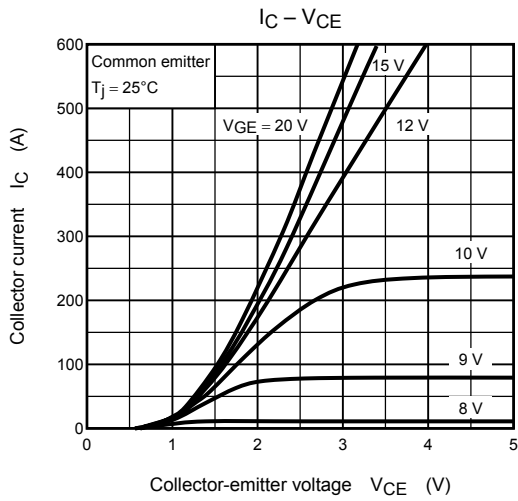

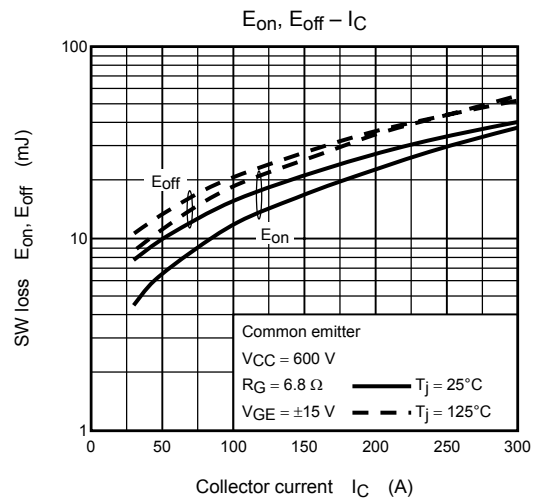
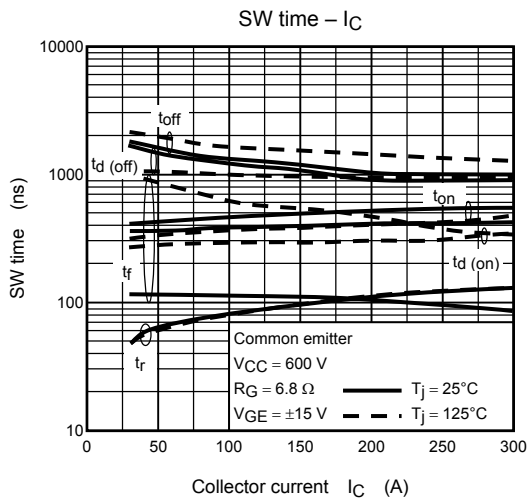
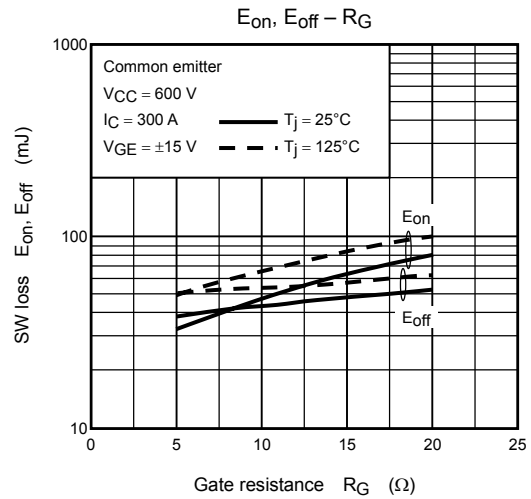
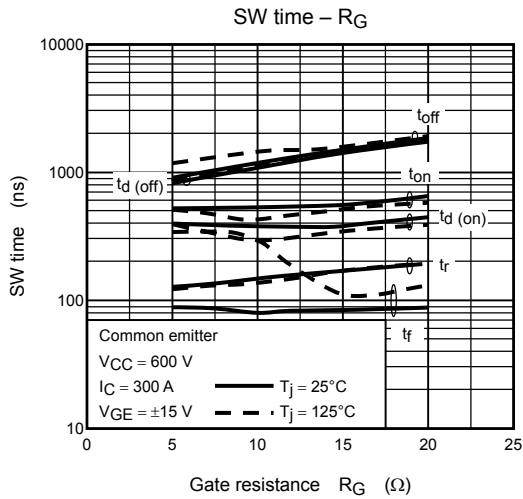
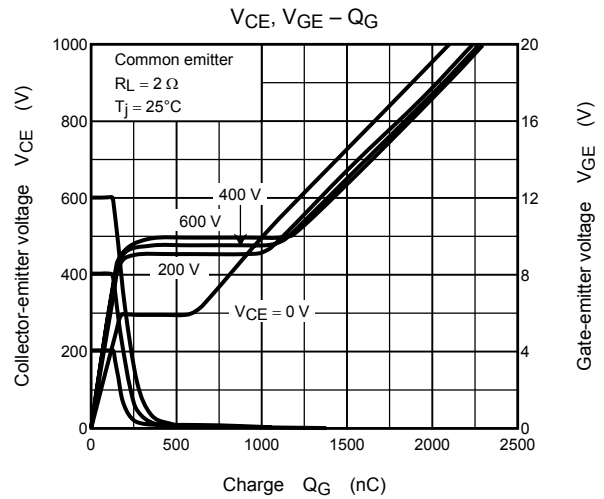
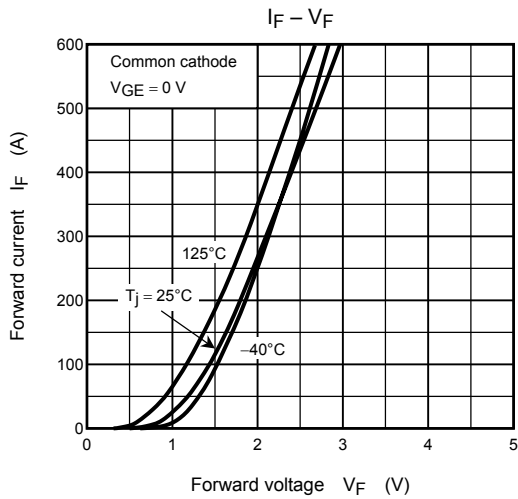

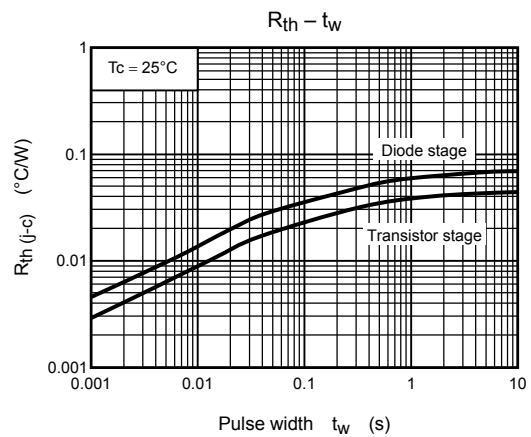
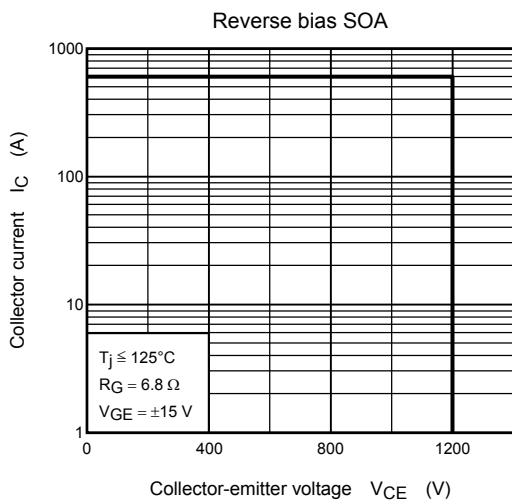
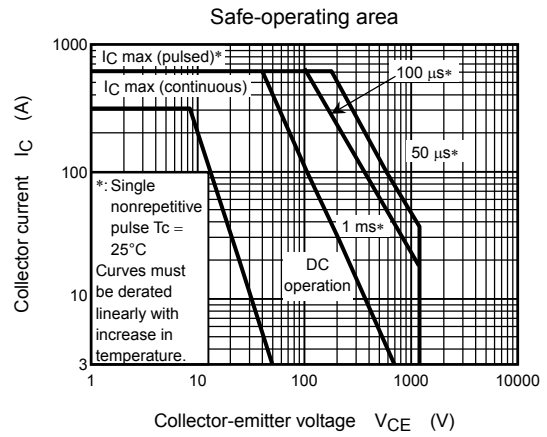
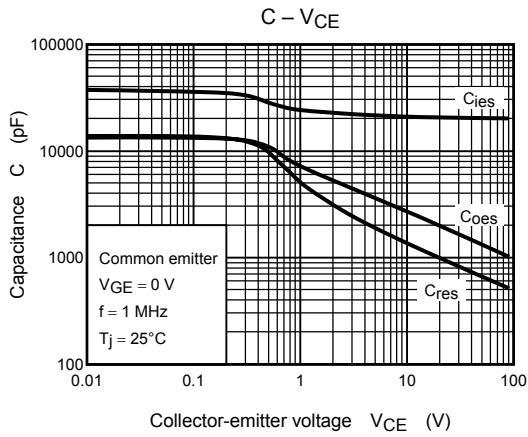
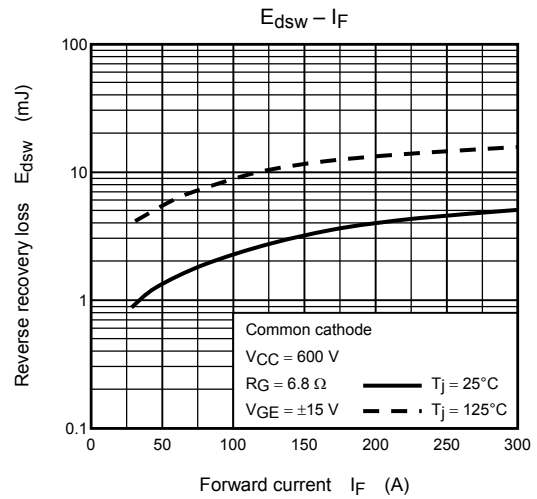
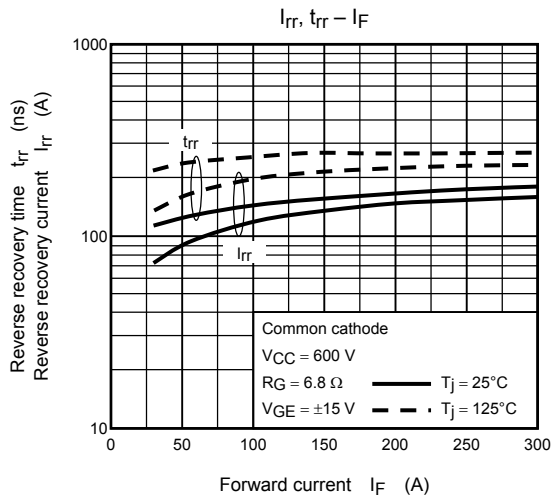

RESTRICTIONS ON PRODUCT USE

030619EAA

- The information contained herein is subject to change without notice.
- The information contained herein is presented only as a guide for the applications of our products. No responsibility is assumed by TOSHIBA for any infringements of patents or other rights of the third parties which may result from its use. No license is granted by implication or otherwise under any patent or patent rights of TOSHIBA or others.
- TOSHIBA is continually working to improve the quality and reliability of its products. Nevertheless, semiconductor devices in general can malfunction or fail due to their inherent electrical sensitivity and vulnerability to physical stress. It is the responsibility of the buyer, when utilizing TOSHIBA products, to comply with the standards of safety in making a safe design for the entire system, and to avoid situations in which a malfunction or failure of such TOSHIBA products could cause loss of human life, bodily injury or damage to property.
In developing your designs, please ensure that TOSHIBA products are used within specified operating ranges as set forth in the most recent TOSHIBA products specifications. Also, please keep in mind the precautions and conditions set forth in the "Handling Guide for Semiconductor Devices," or "TOSHIBA Semiconductor Reliability Handbook" etc..
- The TOSHIBA products listed in this document are intended for usage in general electronics applications (computer, personal equipment, office equipment, measuring equipment, industrial robotics, domestic appliances, etc.). These TOSHIBA products are neither intended nor warranted for usage in equipment that requires extraordinarily high quality and/or reliability or a malfunction or failure of which may cause loss of human life or bodily injury ("Unintended Usage"). Unintended Usage include atomic energy control instruments, airplane or spaceship instruments, transportation instruments, traffic signal instruments, combustion control instruments, medical instruments, all types of safety devices, etc.. Unintended Usage of TOSHIBA products listed in this document shall be made at the customer's own risk.
- TOSHIBA products should not be embedded to the downstream products which are prohibited to be produced and sold, under any law and regulations.